

FA-300-6L Series

LED Fire Alarm Control Panel

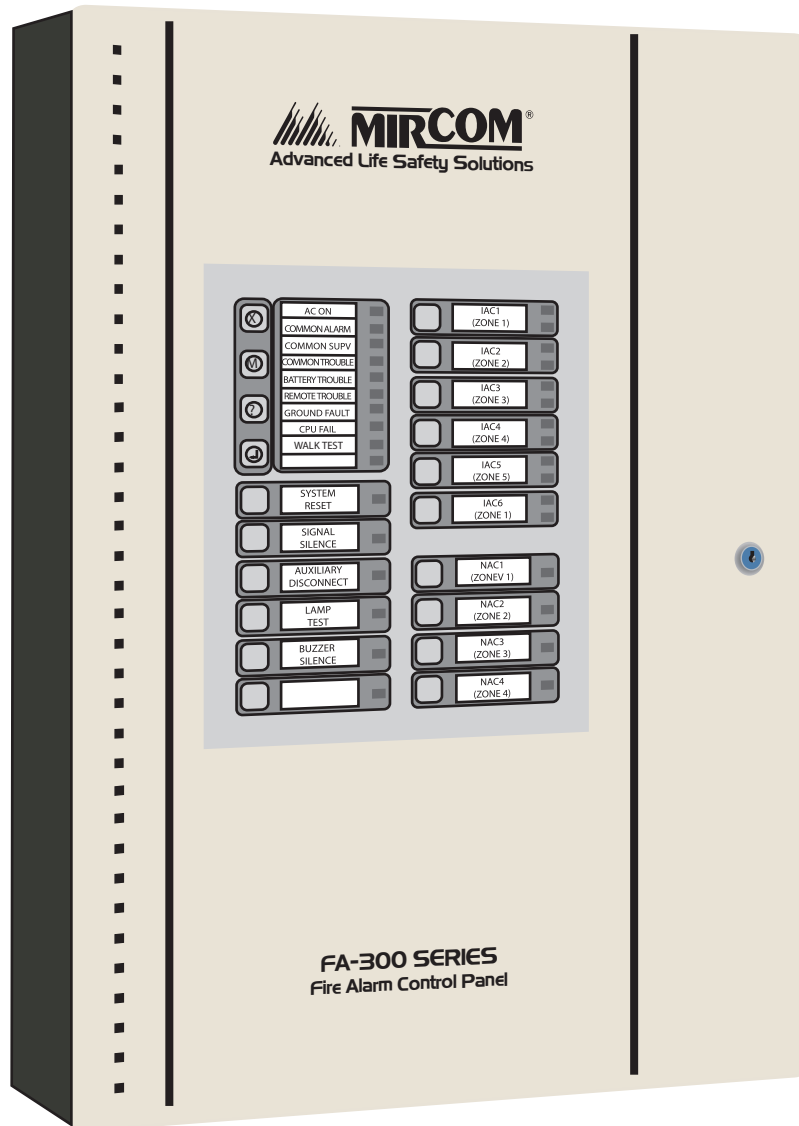

Table of Contents

Industry Canada and FCC Notice	1
Introduction	2
Overall Features	2
Conventions	3
Circuits	3
Zone	3
Display Points	3
Wiring Styles	3
System Components	4
Main Fire Control Panel	4
Relay Modules: Six Relays	4
Polarity reversal/city tie	4
Remote Annunciator	5
Smart Relay Module	5
Input Class A converter: Six Circuits.....	6
Output Class A converter: two circuits	6
Active end-of-line	6
RAM-216 Remote Annunciator	6
Additional Fire Alarm System Accessories	6
Mechanical Installation	7
Installing the Enclosure	7
Installing the Adder Modules	8
Cable and Jumper Connections for Main Board and Adder Modules	9
Main Fire Alarm Board	9
ICAC-306 Input Class-A Converter Adder Module	10
OCAC-302 Output Class-A Converter Adder Module	11
RM-306 Six Relay Adder Module	11
Polarity Reversal and City Tie Module (Model PR-300)	12
Field wiring	13
Main Fire Alarm Board Field Wiring	13
Relay Adder Module Wiring	16
Polarity Reversal and City Tie Module (PR-300) Wiring	17
Power supply connection	18
Wiring Tables and Information	19
Four-Wire Smoke Power (regulated)	19
Supervised Auxiliary Power (regulated)	19
Auxiliary Power (unfiltered)	19
System Checkout	20
Before turning the power "ON"	20
Power-up procedure	20
Troubleshooting	20
Indicators, Controls and Operations	21
Common Indicators	22
Alarm Circuit Indicators	23
Supervisory Circuit Indicators	23
Monitor Circuit Indicators	24
Trouble-only Circuit Indicators	24
Signal Circuit Indicators	24
Common Controls	25
Circuit (zone) disconnect buttons	26
Common Relays	26
Circuit Types	27
Evacuation codes	28

Single Stage Operation	29
Supported Protocols/Devices	30
Synchronous Strobes.....	30
System Sensor's i3 Devices.....	30
Configuration and CFG-300 LCD Service Tool	32
Entering the Passcode	33
Command Menu.....	33
How to Use the Keypad to Program the FA-300.....	34
1. PANEL CONFIG (Command-Menu)	34
2. Config Info (Command-Menu).....	43
3. Set Time (Command-Menu).....	44
4. Set password (Command-Menu)	45
5. View Event Log (Command-Menu).....	45
6. Clear Event Log (Command-Menu)	46
7. Walk Test (Command-Menu)	47
8. i3 Loop Test (Command-Menu)	48
9. Dialer Config (Command-Menu)	49
10. Test Dialer (Command-Menu).....	54
11. Exit (Command-Menu).....	56
CFG-300 LCD Service tool operation	56
Appendix A: Compatible Receivers.....	60
Appendix B: Reporting	61
Ademco Contact-ID.....	61
Security Industries Association SIA-DCS.....	62
Appendix C: Specifications.....	63
Appendix D: Power Supply and Battery Calculations (Selection Guide).....	64
Warranty & Warning Information	65
Warning Please Read Carefully	65
Limited Warranty	67
Warranty Procedure	67
Disclaimer of Warranties	67
Out of Warranty Repairs	68

List of Figures & Tables

Figure 1: Box dimensions, surface mount.....	7
Figure 2: Installation of Adder Modules	8
Figure 3: Main Fire Alarm Board cable connector and jumper settings	9
Figure 4: ICAC-306 Input Class-A Converter Adder Module	10
Figure 5: OCAC-302 Output Class-A Converter Adder Module	11
Figure 6: RM-306 six relay adder module	11
Figure 7: RM-306 Relay programming	12
Figure 8: Polarity reversal and city tie module	12
Figure 9: Initiating circuit – Class B or Style B wiring	13
Figure 10: Initiating circuit– Class A or Style D wiring	14
Figure 11: Indicating circuit – Class B or Style Y wiring	14
Figure 12: Indicating circuit –Class A or Style Z wiring	15
Figure 13: Four-wire smoke detector wiring	15
Figure 14: Dialer wiring	16
Figure 15: Relay per zone (RM-306) Terminal connection	16
Figure 16: Polarity reversal and city tie module terminal connection	17
Figure 17: Power supply connection	18
Figure 18: LED indicators and control buttons	21
Figure 19: Evacuation and Alert Codes	29
Figure 20: FA-300 Configuration	32
Table 1: Connectors and Jumpers on the Main Fire Alarm Board	10
Table 2: PR-300 jumper settings	12
Table 3: Initiating Circuit Wiring	19
Table 4: Indicating Circuit Wiring	19

Industry Canada and FCC Notice

Notice for all FA-300 Series Built-In UDACTs Sold in Canada

Mircom's **FA-300 SERIES BUILT-IN UDACT Communicator** described in this manual is listed by Underwriters Laboratories Canada (ULC) for use in slave application in conjunction with a Listed Fire Alarm Control Panel under Standard ULC-S527 (Standard for Control Units for Fire Alarm Systems) and ULC/ORD-C693-1994 (Central Station Fire Protective Signalling Systems and Services). These Communicators should be installed in accordance with this manual; the Canadian / Provincial / Local Electrical Code; and/or the local Authority Having Jurisdiction (AHJ).

Industry Canada Notice

Repairs to certified equipment should be made by an authorized Canadian maintenance facility designated by the supplier. Any repairs or alteration made by the user to this equipment, or equipment malfunctions, may give the telecommunications company cause to request the user to disconnect the equipment. Users should ensure for their own protection that the **Earth Ground** connections of the power utility, telephone lines and internal metallic water pipe system, if present, are connected together. This is necessary both for proper operation and for protection.



CAUTION: Users should not attempt to make such connections themselves, but should contact the appropriate electric inspection authority, or electrician, as appropriate

Notice for all FA-300 Series Built-in UDACTs Sold in the U.S.A.



Note: The Ringer Equivalence Number (REN) assigned to each terminal device provides an indication of the maximum number of terminals allowed to be connected to a telephone interface. The termination on an interface may consist of any combination of devices subject only to the requirement that the sum of the Ringer Equivalence Numbers of all the devices does not exceed 5.

The REN for this product is part of the product identifier that has the format US:AAAEQ##TXXXX. The digits represented by ## are the REN without a decimal point (e.g., 03 is a REN of 0.3). For earlier products, the REN is separately shown on the label.

Mircom's **FA-300 SERIES BUILT-IN UDACT Digital Communicator** described in this manual is listed by Underwriters Laboratories Inc. (ULI) for use in slave application in conjunction with a Listed Fire Alarm Control Panel under Standard 864 (Control Units for Fire Protective Signalling Systems). These Communicators comply with the National Fire Protection Association (NFPA) performance requirements for DACTs and should be installed in accordance with NFPA 72 Chapter 4 (Supervising Station Fire Alarm System). These Communicators should be installed in accordance with this manual; the National Electrical Code (NFPA 70); and/or the local Authority Having Jurisdiction (AHJ).

FCC Notice

This equipment complies with Part 68 of the FCC rules and the requirements adopted by the ACTA. On the telco transformer of this equipment is a label that contains, among other information, a product identifier in the format US:AAAEQ##TXXXX. If requested, this number must be provided to the telephone company. This equipment is capable of seizing the line. This capability is provided in the hardware.

Type of Service: The **Communicator** is designed to be used on standard device telephone lines. It connects to the telephone line by means of a standard jack called the USOC RJ-11C (or USOC FJ45S). Connection to telephone company provided coin service (central office implemented systems) is prohibited. Connection to party lines service is subject to state tariffs.

Telephone Company Procedures: The goal of the telephone company is to provide you with the best service it can. In order to do this, it may occasionally be necessary for them to make changes in their equipment, operations or procedures. If these changes might affect your service or the operation of your equipment, the telephone company will give you notice, in writing, to allow you to make any changes necessary to maintain uninterrupted service.

In certain circumstances, it may be necessary for the telephone company to request information from you concerning the equipment which you have connected to your telephone line. Upon request of the telephone company, provide the FCC registration number and the ringer equivalence number (REN); both of these items are listed on the equipment label. The sum of all of the REN's on your telephone lines should be less than five in order to assure proper service from the telephone company. In some cases, a sum of five may not be usable on a given line.

If Problems Arise: If any of your telephone equipment is not operating properly, you should immediately remove it from your telephone line, as it may cause harm to the telephone network. If the telephone company notes a problem, they may temporarily discontinue service. When practical, they will notify you in advance of this disconnection. If advance notice is not feasible, you will be notified as soon as possible. When you are notified, you will be given the opportunity to correct the problem and informed of your right to file a complaint with the FCC. Contact your telephone company if you have any questions about your phone line. In the event repairs are ever needed on the Communicator, they should be performed by Mircom Technologies Ltd. or an authorized representative of Mircom Technologies Ltd. For information contact Mircom Technologies Ltd. at the address and phone numbers shown on the back page of this document.

Introduction

Mircom's FA-300 Series Fire Alarm Control Panel is a Digital Signal Processor (DSP)-based fire panel. The FA-300 provides six supervised Class B or A (Style B or D) Initiating circuits, and four supervised Class B or A (Style Y or Z) indicating circuits. All circuits are supervised for opens and ground faults, and indicating circuits are supervised for shorts. Optional modules include Relay, Polarity Reversal and City Tie and Class A Converters for initiating and indicating circuits. Semi-flush or surface mountable enclosures can be used for retrofits and on new installations.



Note: Installation of the FA-300 series fire alarm control panel should be in accordance with Canadian Electrical Code Part 1, ULC-S524 installation of Fire Alarm System, National Electrical Code NFPA 70 and NFPA 72. Final acceptance subject to the Local Authority Having Jurisdiction (AHJ). Testing and maintenance as per ULC-S536

Overall Features

- Basic unit has six Class B (Style B) initiating circuits, which may be configured as Class A (Style D) using input Class A converter adder modules. Each initiating circuit can be configured as Alarm, Verified Alarm, Water flow Alarm, Sprinkler Alarm, Latching or Non-Latching Supervisory, Monitor or Trouble-Only circuit. There are two LEDs per circuit, one for Trouble (amber), and one dual color (amber/red) LED for Supervisory (amber) and Alarm (red).
- Basic unit has four Power Limited Class B (Style Y) indicating circuits with individual trouble indicators. Each indicating circuit may be configured as Class A (Style Z) using output Class A converter adder module. Each indicating circuit may be configured as Silenceable signal, non Silenceable signal, Silenceable strobe, non Silenceable strobe. The audible signal may be Steady, Temporal Code, California Code, or March Time.
- A pushbutton associated with each initiating and indicating circuit can individually disconnect the circuit.
- Configurable Signal Silence Inhibit, Auto Signal Silence, and One-Man Walk Test.
- Subsequent Alarm, Supervisory, and Trouble operation
- Four-wire resettable smoke power supply 300mA maximum
- Relay Contacts for Common Alarm, Common Supervisory and Common Trouble all non-disconnectable and Auxiliary Alarm Relay (disconnectable).
- RS-485 Interface for LCD Annunciators, RA-1000 Series Remote Multiplex Annunciators and Smart relay adder.
- Optional Modules for additional Relay Circuits, City Tie and Polarity Reversal Signaling.
- Extensive transient protection
- With or without built-in UDACT (Digital Alarm Communicator Transmitter)
- Easy configuration of the panel and built-in UDACT using LCD service tool (CFG-300)
- Remote dial up (with built-in UDACT version) for event log checking and/or configuration changing
- Laptop programmer for direct configuration changing and log checking

Conventions

Circuits

Refers to an actual electrical interface for Initiating (Detection) and Indicating (Signal) or Relays.

Zone

Is a logical concept for a Fire Alarm Protected Area, and will consist of at least one Circuit.

Often the terms Zone and Circuit are used interchangeably, but in this Manual the term Circuit is used.

Display Points

There is a display point associated with every initiating and indicating circuit of the FA-300 LED Series fire panel. For an initiating circuit there are two LEDs for every display point: one single color (amber) and one dual color (red/amber). For an indicating circuit there is only one LED: one single color (amber), for every display point.

Wiring Styles

Initiating and indicating circuits are Class B (Style B and Y). Changing the initiating circuits to Class A requires an ICAC-306 adder board which will convert SIX initiating zones from Class B (Style B) circuits to Class A (Style D). This is done without penalizing the number of circuits, which remains the same as in Class B (Style B). Changing the indicating circuits to Class A requires an OCAC-302 adder board which will convert TWO indicating zones from Class B (Style Y) circuits to Class A (Style Z).

System Components

Main Fire Control Panel

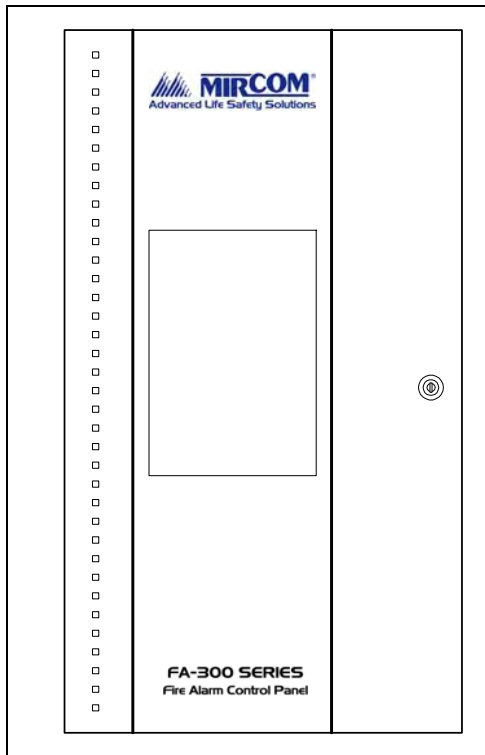
 <p>The image shows the front panel of a fire alarm control panel. It features a vertical array of indicator lights on the left side. The central area contains a large rectangular display screen. Above the screen is the MIRCOM logo and the text 'Advanced Life Safety Solutions'. Below the screen, it says 'FA-300 SERIES Fire Alarm Control Panel'. A circular dial is located on the right side of the panel.</p>	Model	Description
	FA-300-6LD(R/W)*	6 Zone Fire Alarm Control Panel with LED display (white door, black box). 6 Class B (Style B) Initiating circuits, and two Power Limited Class B (Style Y) Indicating circuits (up to 1.70 amperes each, 5 amperes total). One six zone ICAC-306 Input Class A Converter adder modules may be used for Class A (Style D) wiring of Initiating circuits. One OCAC-302 Output Class A Converter adder module may be used for Class A (Style Z) wiring of the Indicating circuits. The FA-300-6LD contains Common Alarm, Common Supervisory & Common Trouble Relays, auxiliary alarm relay (disconnectable), an RS-485 Interface for Remote Annunciators and a Resettable Four Wire Smoke Detector Power Supply. The unit has a dialer on main board. Used with BA-110 (10 amp-hour) (Sota Enertech model SA12120) batteries (two required).
	FA-300-6L	Six-zone Fire Alarm with LED display. Same as except without dialer.

*R = red door; W = white door

Relay Modules: Six Relays

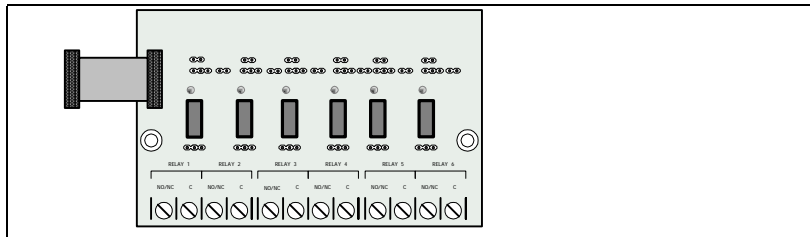
 <p>The image shows a relay module with six relays. Each relay has a vertical slider switch and a terminal block with two terminals. The relays are labeled RELAY 1 through RELAY 6. Below the relays, there are labels for 'NO/NC' and 'C' terminals. A circular dial is on the left side.</p>	Model	Description
	RM-306	Six-relay adder module

Polarity reversal/city tie

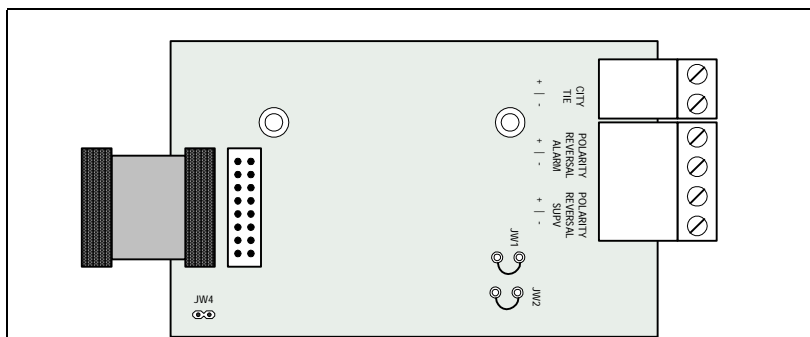
 <p>The image shows a module with two terminal blocks. The top block has terminals for 'CITY TIE' and 'POLARITY REVERSAL'. The bottom block has terminals for 'POLARITY REVERSAL' and 'SUPPLY'. There are also labels for 'ALARM' and 'SUPPLY'. Two relays, JW1 and JW2, are shown at the bottom. A circular dial is on the left side.</p>	Model	Description
	PR-300	Polarity Reversal and/or City tie Module

Remote Annunciator

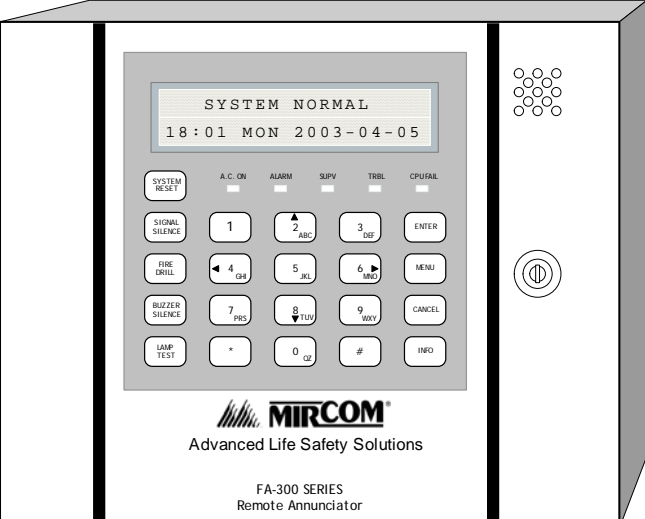
	Model	Description
	RAM-300LCDW	Remote Annunciator module, LCD display, white painted box
	RAM-300LCDR	Remote Annunciator Module, LCD display, red painted box

Smart Relay Module

	Model	Description
	SRM-312W	Smart Relay Module (12 relays) with white enclosure
	SRM-312R	Smart Relay Module (12 relays) with red enclosure

Input Class A converter: Six Circuits

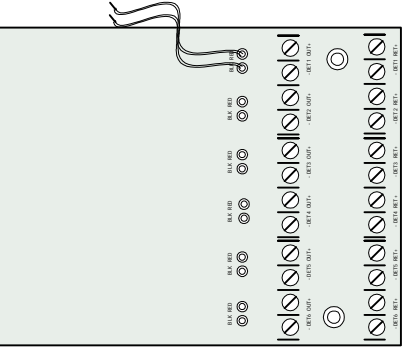
	Model	Description
	ICAC-306	Input Class A converter Module (six circuits). This module has built in Active End-of-Line resistors.

Output Class A converter: two circuits

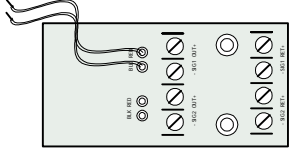
	Model	Description
	OCAC-302	Output Class A converter module (two circuits)

Active end-of-line

The ELRX-300 are power-saving End-of-Line resistors that eliminate the need for an additional battery cabinet or larger batteries in order to meet the 60 hour standby requirement.

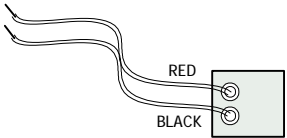
	Model	Description
	ELRX-300	Active end-of-line resistor without plate
	ELRX-300R	Active end-of-line resistor with end-of-line red plate

RAM-216 Remote Annunciator

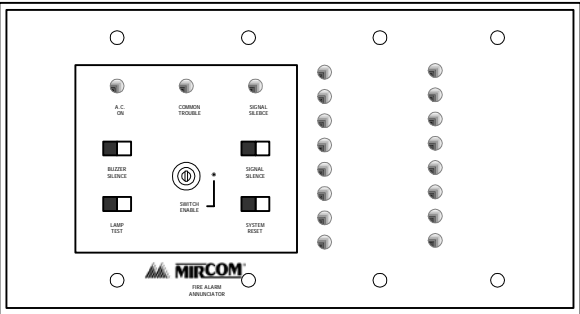
	Model	Description
	RAM-216	16 Zone remote annunciator

Additional Fire Alarm System Accessories

- Model: **RAM-208** Eight Zone Remote Annunciator (ULC and ULI Approved)
- Model: **RTI-1** Remote Trouble Indicator (ULC and ULI Approved)
- Model: **MP-300** End-of-line resistor plate, 3.9K ohm (ULC and ULI Approved)
- Model: **MP-300R** End-of-line resistor plate, red (ULC Approved)
- Model: **BC-160** External Battery Cabinet (ULC and ULI Approved)

Mechanical Installation

Installing the Enclosure

Install the FA-300 Series Fire Alarm Panel enclosure as shown below. Mount enclosure surface mount using the four mounting holes, as shown and the screws provided.

Figure 1: Box dimensions, surface mount

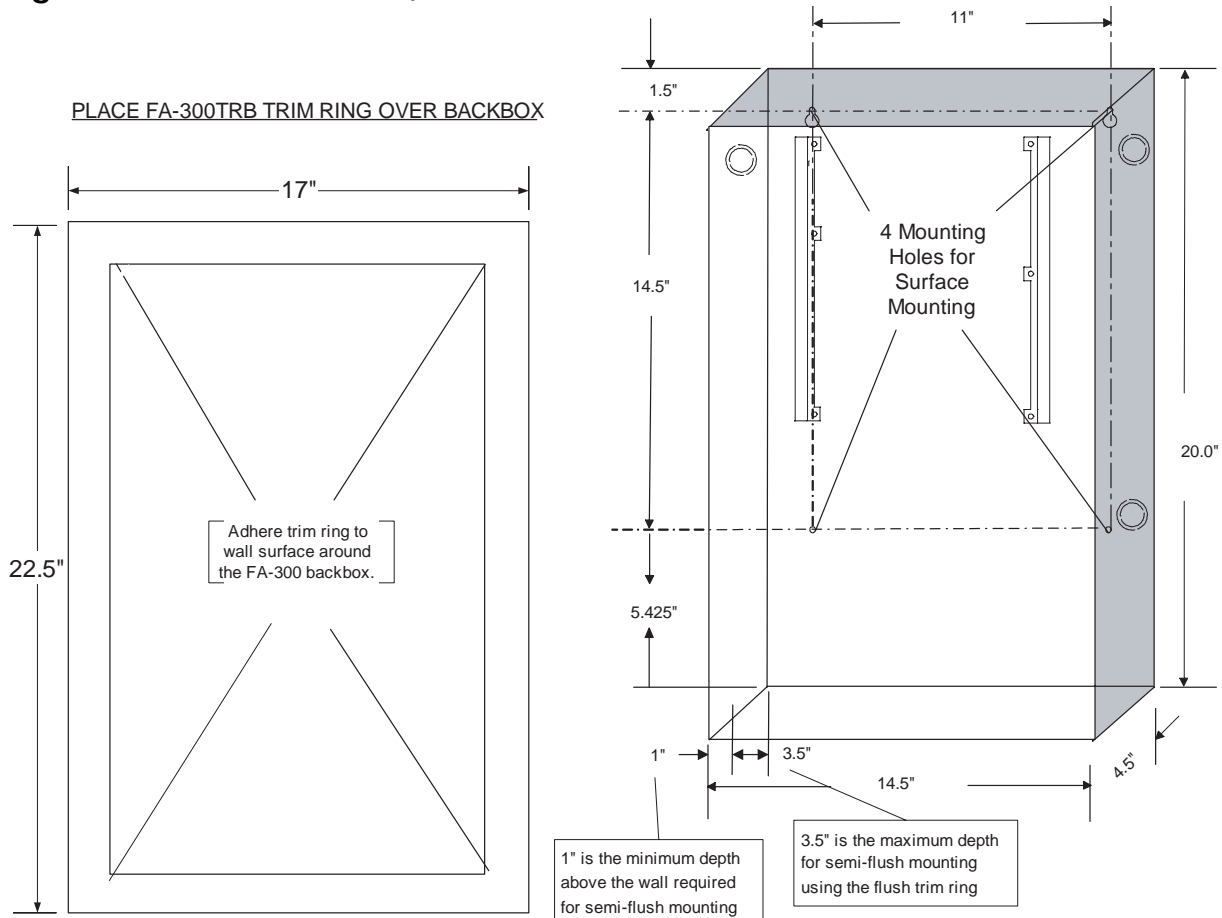

Remove the door (also disconnect the ground strap), the dead front and semi-flush mount the backbox into the wall. Peel the adhesive cover from the trim ring and stick to the wall surface around the backbox, after wall is finished.

The figure below shows a cross-section of the semi-flush mounted backbox and the trim ring. Make sure to **allow a minimum depth of 1" above the wall surface** for proper door opening.

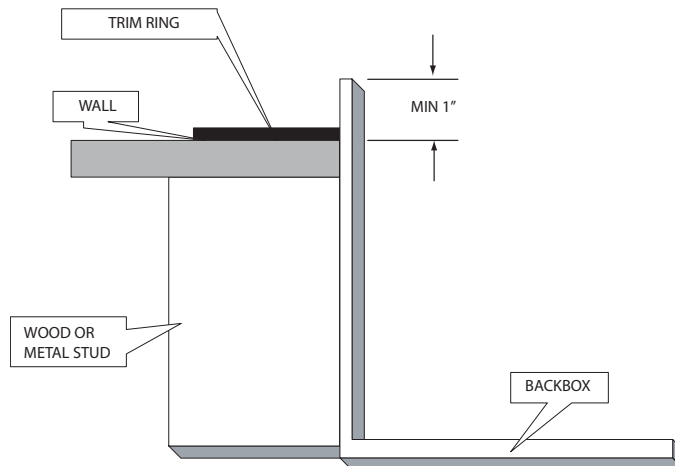

Installing the Adder Modules

FA-300 Series Fire Alarm panels come pre-assembled with all components and boards except for Adder Modules. Module installation locations are shown below. Refer to *Figure 3* on the next page for Jumper or DIP Switch settings and see *Wiring Tables and Information* for wiring specifications.

Figure 2: Installation of Adder Modules

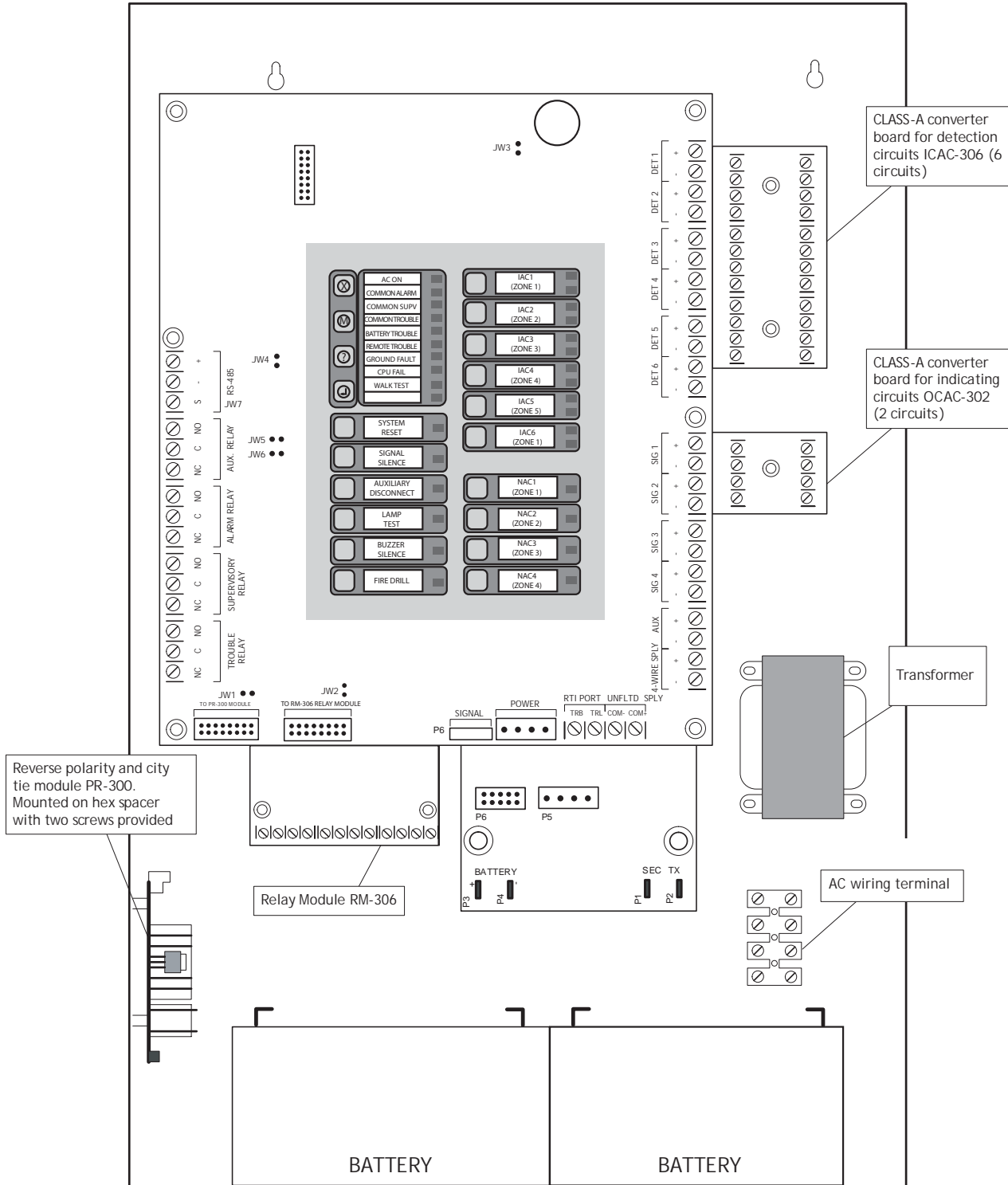

Cable and Jumper Connections for Main Board and Adder Modules

Main Fire Alarm Board

Figure 3: Main Fire Alarm Board cable connector and jumper settings

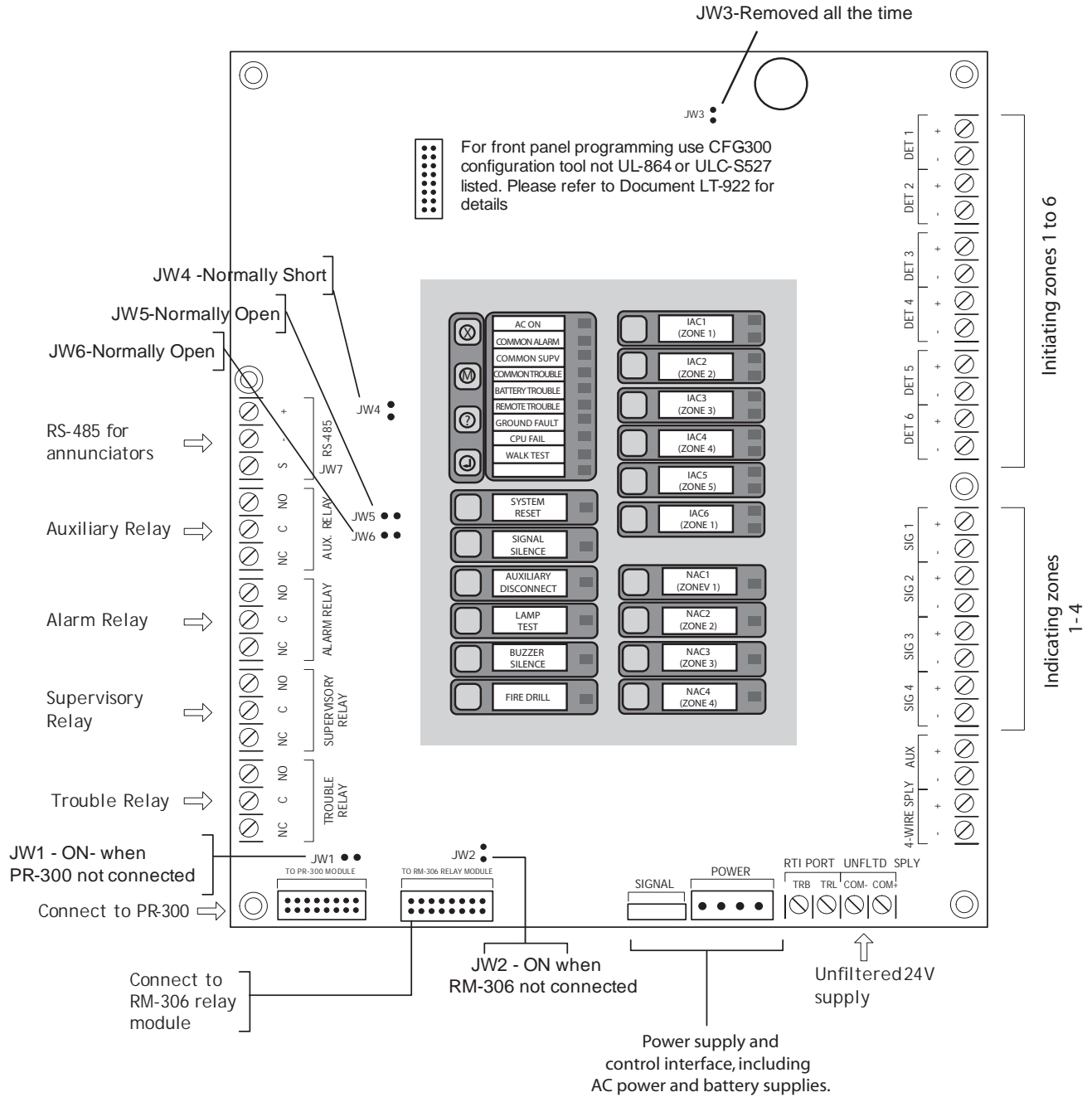
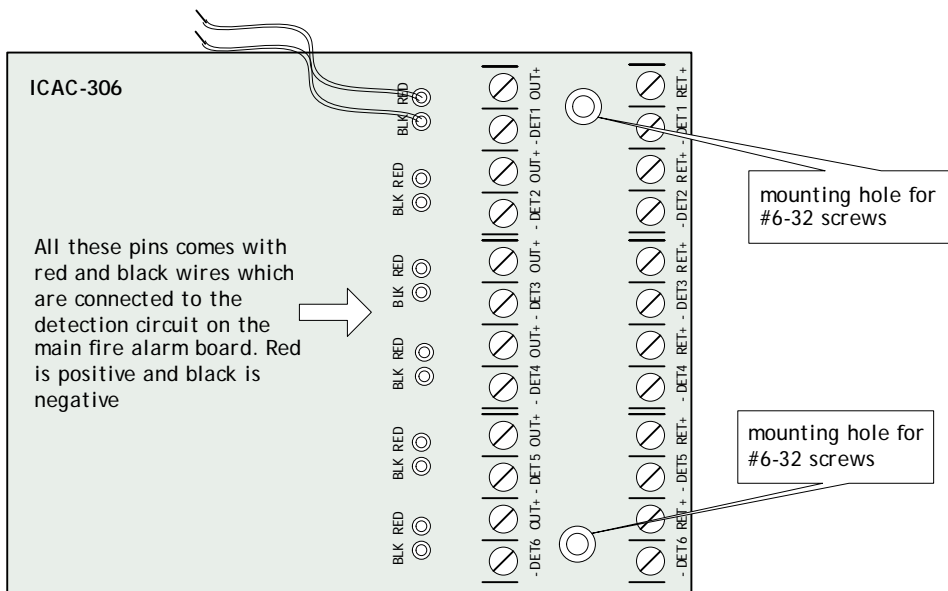

Table 1: Connectors and Jumpers on the Main Fire Alarm Board

JW1	Remove this jumper if PR-300 is connected.
P4	Cable from connector P1 of the RM-306 Relay Adder Module connects here. Otherwise not used.
JW2	Remove this jumper if an RM-306 Relay Adder Module is used.
JW3	Removed all the time.
JW4	Normally short.
JW5	Normally open. Place jumper here and power down the panel (both AC power and batteries). Then power up the panel again, the password is restored to the default after system startup. Once the system has reset, REMOVE the jumper from the pins at JW5. Leave normally open.
JW6	Normally open to BLOCK configuration via modem, PC with a UIMA converter module or a CFG-300 Configuration Tool. Place jumper here to ALLOW any type of configuration.

ICAC-306 Input Class-A Converter Adder Module

Figure 4: ICAC-306 Input Class-A Converter Adder Module



There are no jumpers or cables to set on this module, just wiring from the converter (wires are fixed here) to the Main Fire Alarm Board.

Initiating circuits must be wired from the ICAC-306 module to the Main Fire Alarm board. For example, Initiating circuit 1 positive (red) and negative (black) wires are connected to the positive and negative terminals (respectively) of Initiating circuit 1 on the Main Fire Alarm Board. From the ICAC-306 converter Initiating circuits are wired out to the devices from the positive and negative terminals marked DET OUT and the circuit return wires are brought back to the converter module to positive and negative terminals marked DET RET.

OCAC-302 Output Class-A Converter Adder Module

Figure 5: OCAC-302 Output Class-A Converter Adder Module

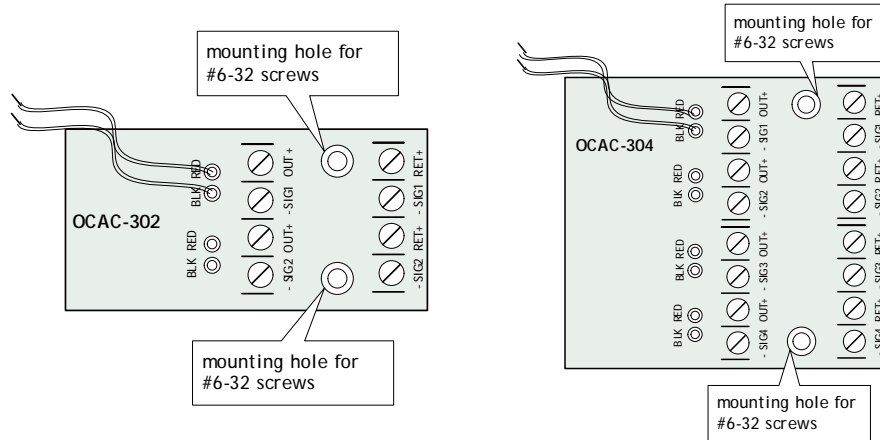

Indicating circuits must be wired from the OCAC-302 to the main Fire Alarm board. For example indicating circuit 1 positive (red wire) and negative (black wire) is wired from the Class A converter module to the positive and negative terminals of Indicating circuit 1 on the Main Fire Alarm board.

The actual indicating zone is wired from the SIGNAL OUT positive and negative to the signaling devices and then wired back to the SIGNAL RET positive and negative.

RM-306 Six Relay Adder Module

Cable from P1 of the RM-306 is connected to P4 on the Main Fire Alarm Board. The jumpers located above each relay on the RM-306 are used to configure the relays. The jumpers located below the relays are used to select either normally open contacts or normally closed contacts.

Figure 6: RM-306 six relay adder module

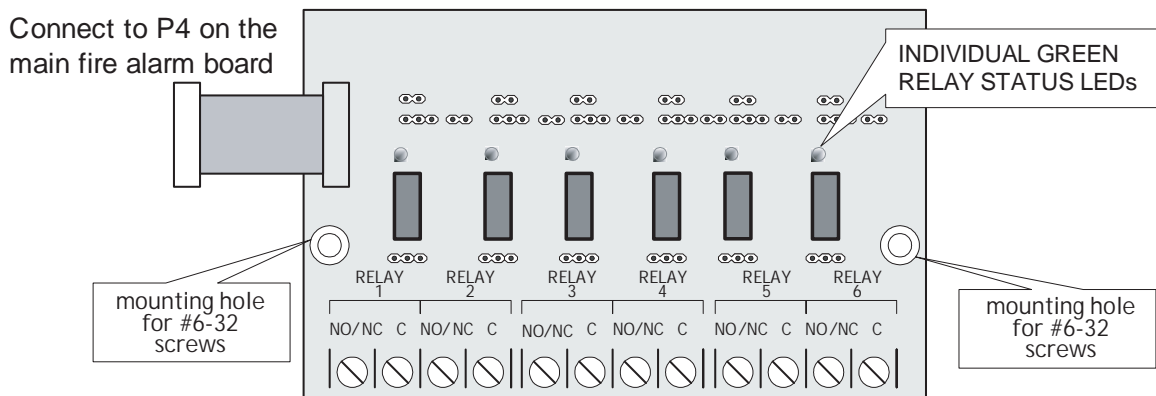

P1: Cable from RM-306 Relay Adder Module connects to P4 on Main Fire Alarm Board.

Programming the relays

See explanation in Figure 7.



Note: Relay programming should be done before installing the board

Figure 7: RM-306 Relay programming

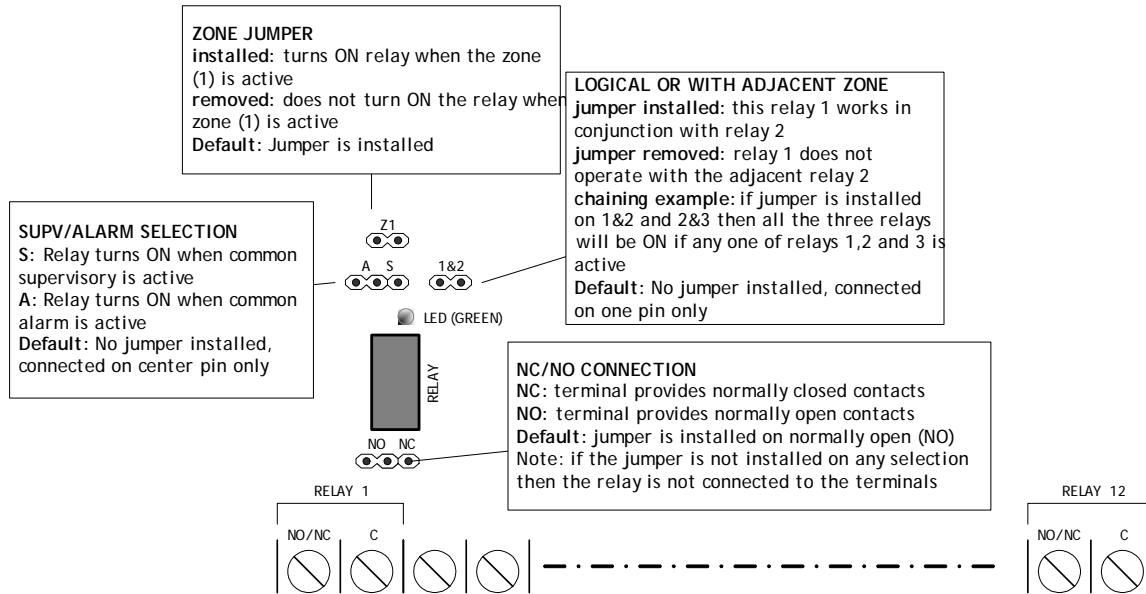

Polarity Reversal and City Tie Module (Model PR-300)

Figure 8: Polarity reversal and city tie module

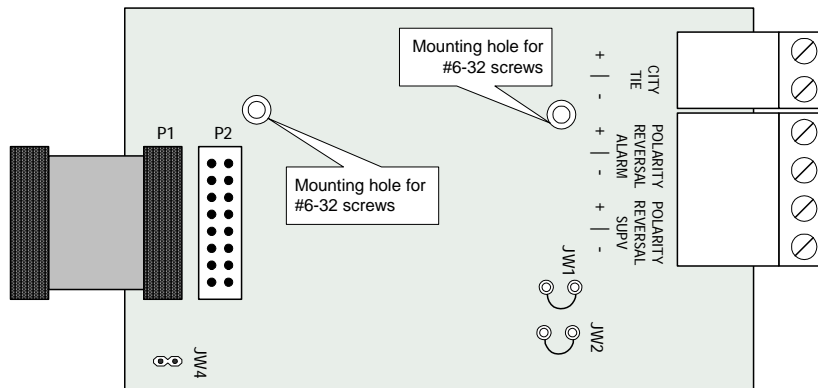

The following hardware configuration must be performed before installing the PR-300.

Table 2: PR-300 jumper settings

P1	Cable connects to P3 on the Main Fire Alarm Board
JW1	Cut this jumper for Trouble transmission. When this jumper is cut and a system trouble occurs, the designated terminals will transmit a "zero volts" or "open" circuit. Please note that in normal condition, the terminals polarity is read exactly as labeled on the circuit board.
JW2	Cut this jumper for Trouble transmission of supervisory. When this jumper is cut and a supervisory trouble occurs, the designated terminals will transmit a "zero volts" or "open" circuit. Please note that in normal condition, the terminals polarity is read exactly as labeled on the circuit board.

The Alarm Transmit signal to the PR-300 can be programmed to turn OFF when signal silence is active. This allows the City Tie Box to be manually reset. On subsequent alarms the silenceable signals will resound and the City Tie Box will be retriggered. See *Configuration and CFG-300 Service Tool* on page 32 for more information.

The Trouble Transmit signal to the PR-300 can be programmed to delay AC power fail for 0, 8 or 18 hours if this is the only system trouble. See *Configuration and CFG-300 Service Tool* on page 32 for more information.

Field wiring

Main Fire Alarm Board Field Wiring

Wire devices to the terminals as shown in the figures that follow. Refer to the Wiring Tables on page 19 for wire gauges.



CAUTION: Do not exceed power supply ratings.

Initiating Circuit Wiring

Wiring diagrams for the initiating circuits are shown below. The panel supports Style B wiring for the initiating circuits and Style D wiring for the indicating circuits. The initiating circuits are supervised by a 3.9K End-of-Line Resistor or for power saving an Active-End-of-Line.



Note: According to Configuration, End-of-Line Resistors on initiating circuits must be all 3.9K ohms or all Active End-of-Line resistors.

Figure 9: Initiating circuit – Class B or Style B wiring

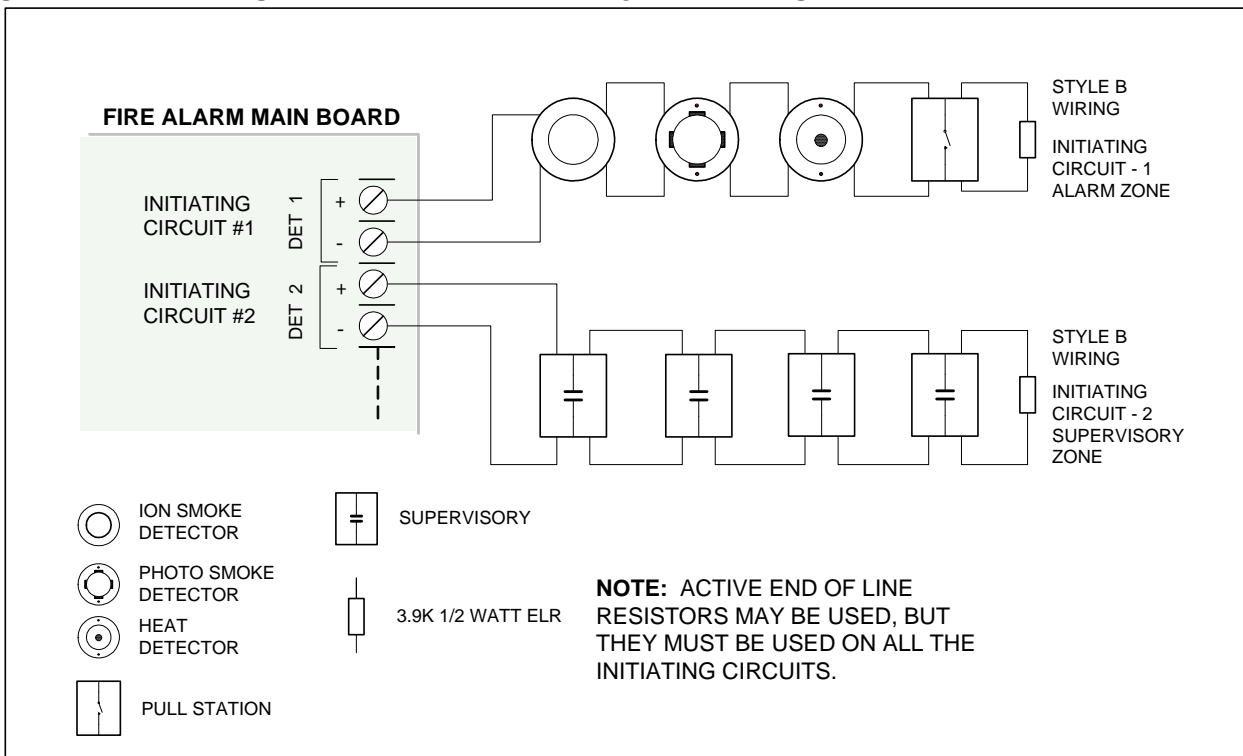
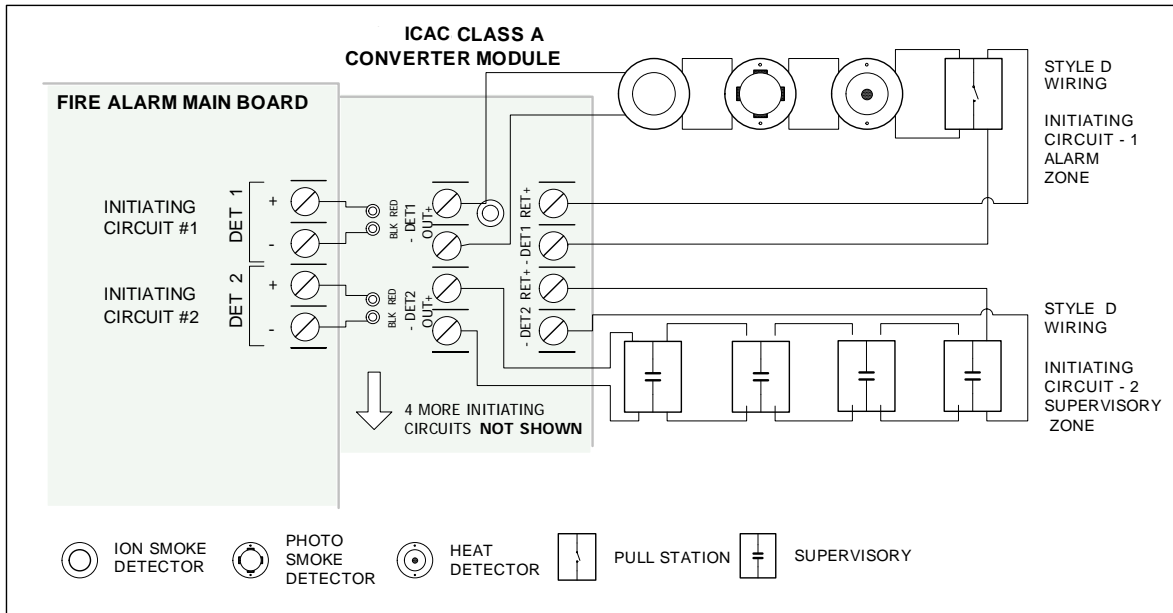

Figure 10: Initiating circuit– Class A or Style D wiring



Note: When using ICAC Class A Converter Adder Modules, always use Active End-of-Line resistors on all initiating circuits including those that are not converted to Class A.

Indicating Circuit Wiring

The FA-300 Series Fire Alarm supports Class B or Style Y and Class A Style Z wiring for its indicating circuits. Each circuit is supervised by a 3.9K End-of-Line resistor. Each indicating circuit provides up to 1.7 A, 5 A maximum total if no auxiliaries are used.



Note: An Active End-of-Line resistor CANNOT be used with any indicating circuits. Always use 3.9K End of Line resistors for indicating circuits.

Figure 11: Indicating circuit – Class B or Style Y wiring

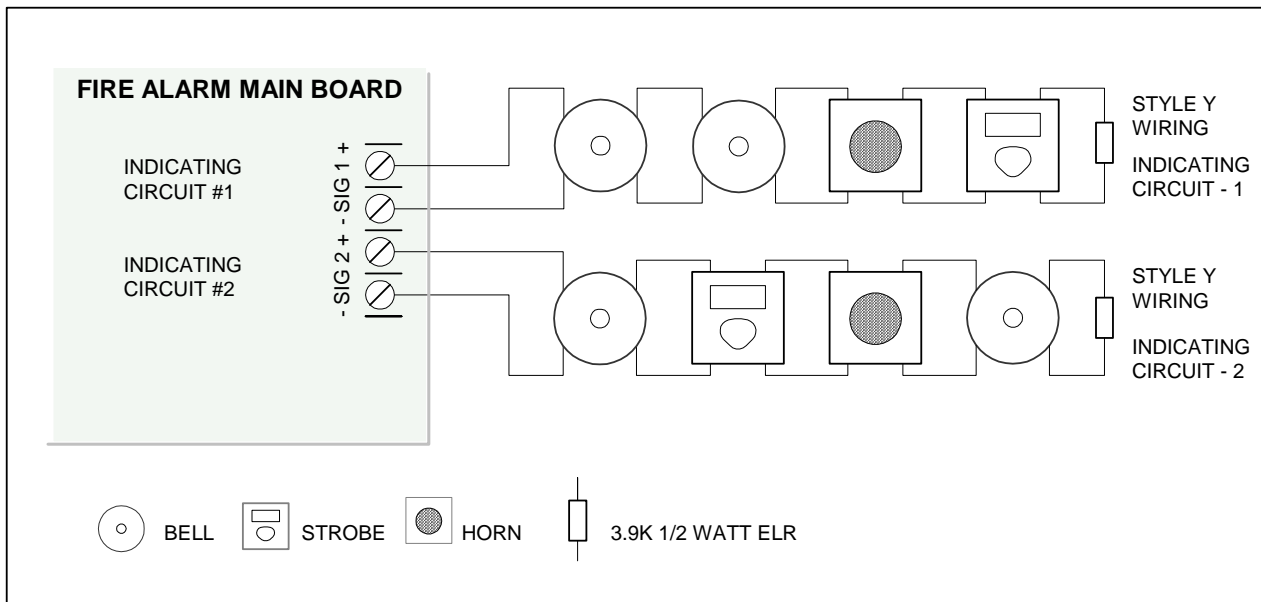
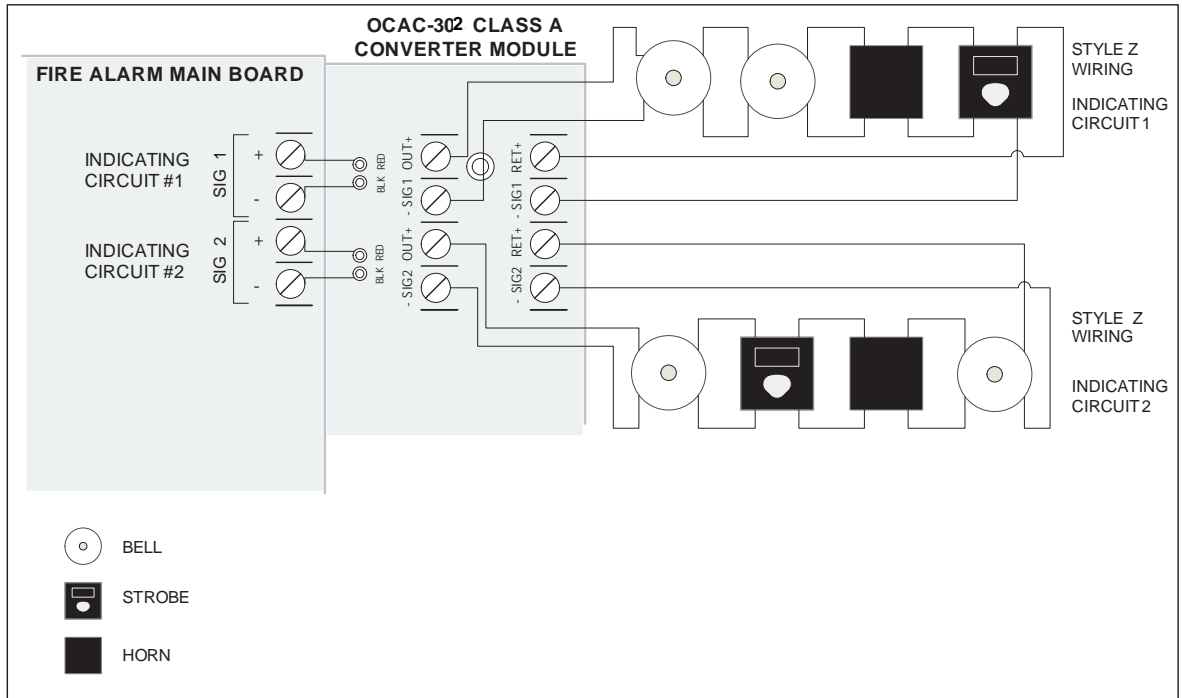
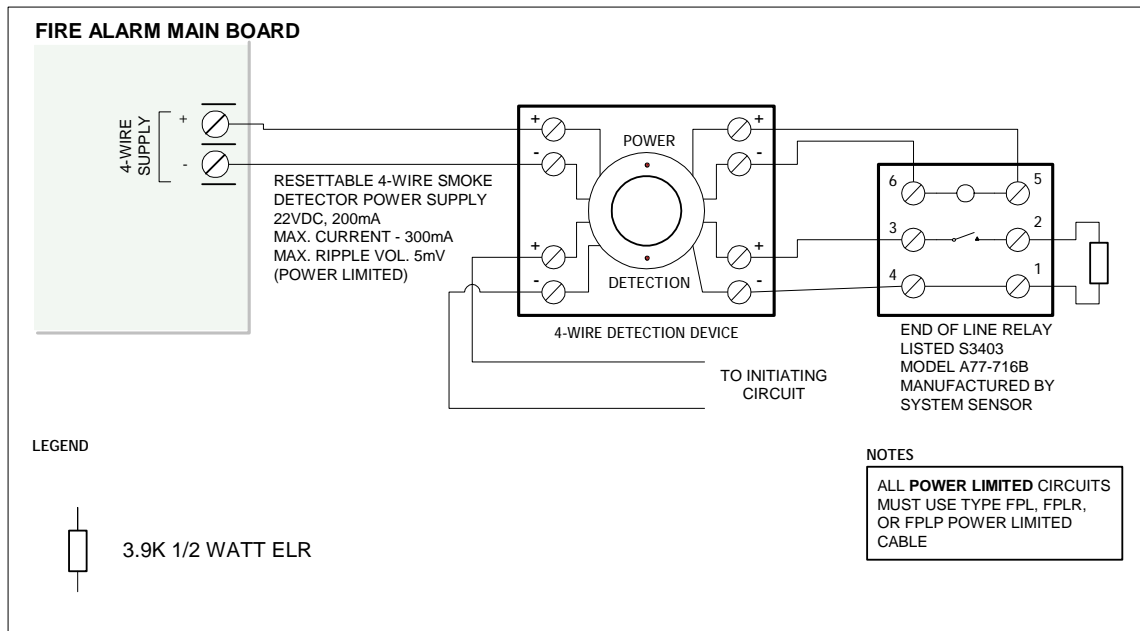

Figure 12: Indicating circuit –Class A or Style Z wiring



Four Wire Smoke Detector Wiring

Figure 13: Four-wire smoke detector wiring



Dialer Wiring

If you have Fire Alarm Panel Model FA-300-6LD there is a dialer on board and terminals marked Line 1 and Line 2 must be wired as shown in Figure 14 below.

Figure 14: Dialer wiring

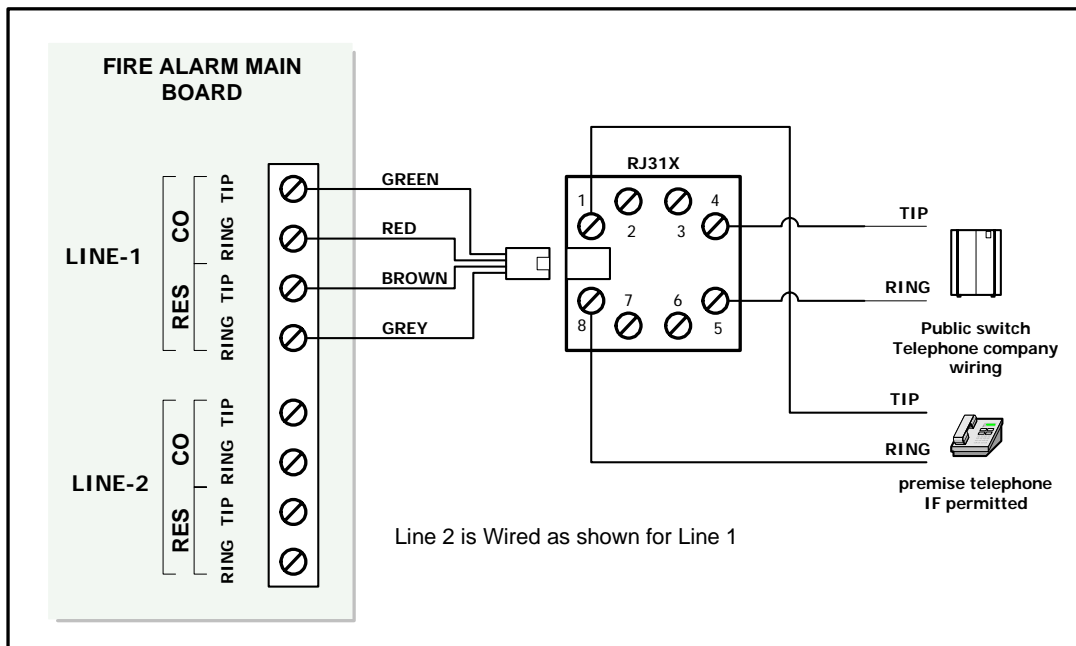

Relay Adder Module Wiring

Wire relays on the relay adder module RM-306 as shown in Figures 15.

Figure 15: Relay per zone (RM-306) Terminal connection

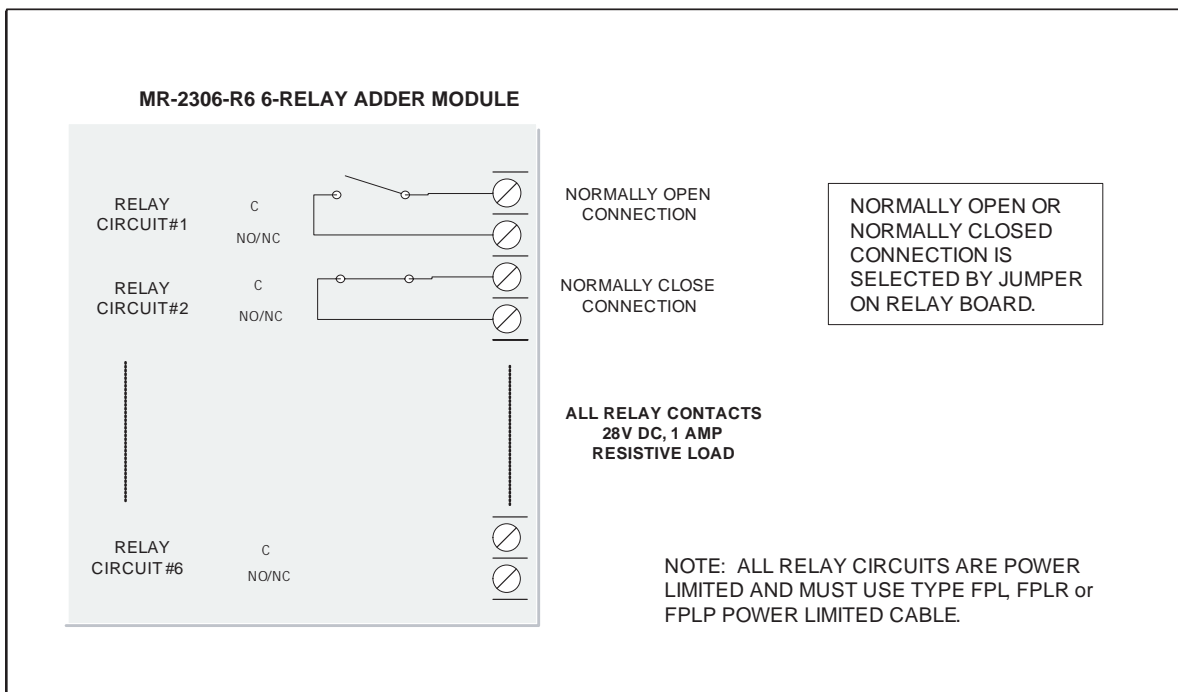

Polarity Reversal and City Tie Module (PR-300) Wiring

Wire PR-300 Polarity Reversal and City Tie Module (if used) as shown in *Figure 16*, below. Power Limited cable type FPL, FPLR or FPLP must be used.

For USA installation, the installer must use **Atlantic Scientific (Tel: 407-725-8000), Model #24544 Protective Device**, or similar **UL-Listed QVRG secondary protector**, as shown.

For use in Canada, the Protective Device is not required but still recommended.

Figure 16: Polarity reversal and city tie module terminal connection

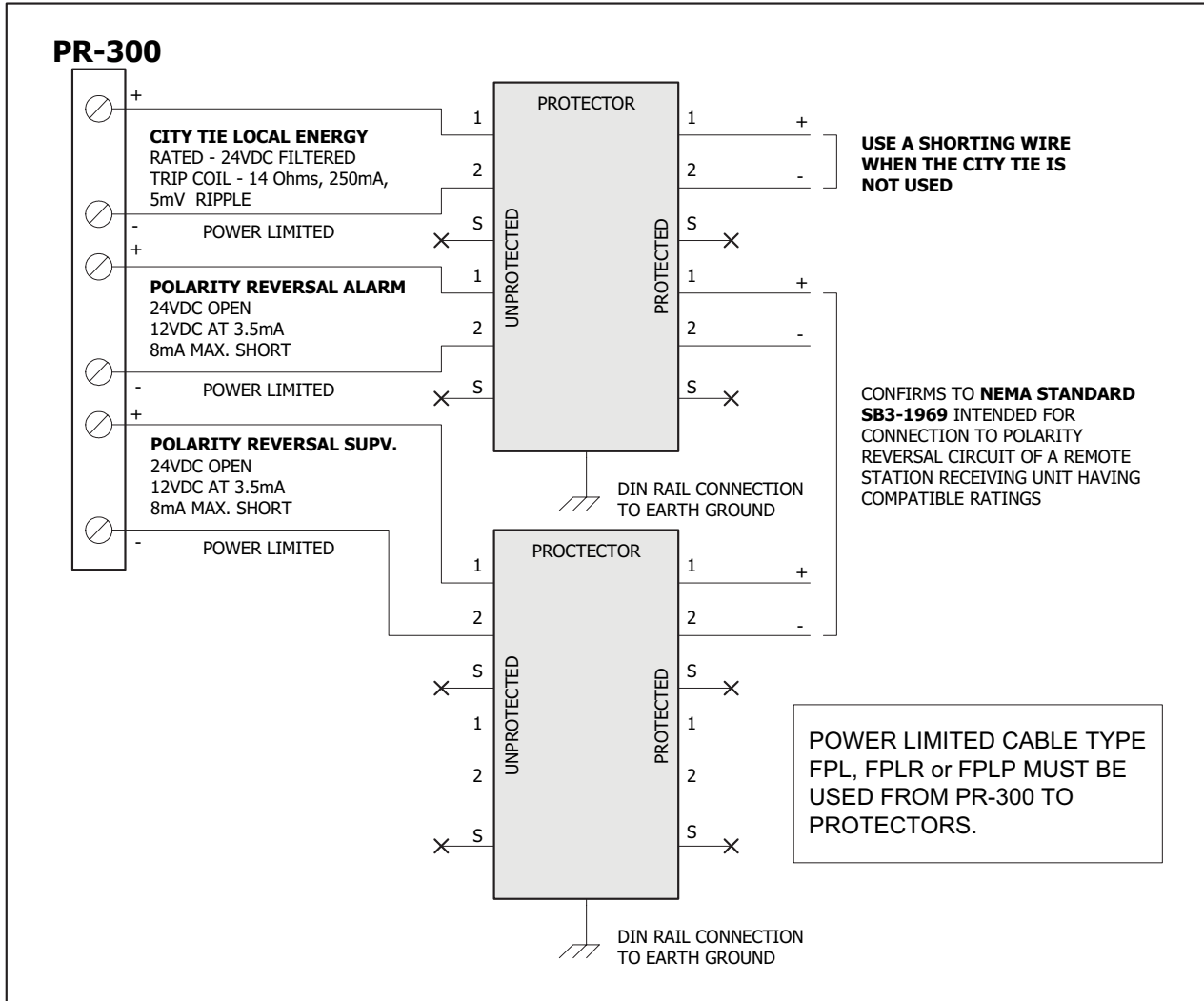

Power supply connection

The power supply is part of the Main Chassis. The ratings are:

Type	Rating
Electrical Input rating	120VAC, 60Hz, 1.7A / 240VAC, 50Hz, 85A, 10A slow blow fuse on secondary of transformer
Power supply total current	6.35A maximum at secondary of transformer
Battery fuse on Main module	10A, slow blow micro fuse

Wire the power supply as shown in *Figure 17* using the proper wire gauge.



CAUTION: Do not exceed power supply ratings.

Figure 17: Power supply connection

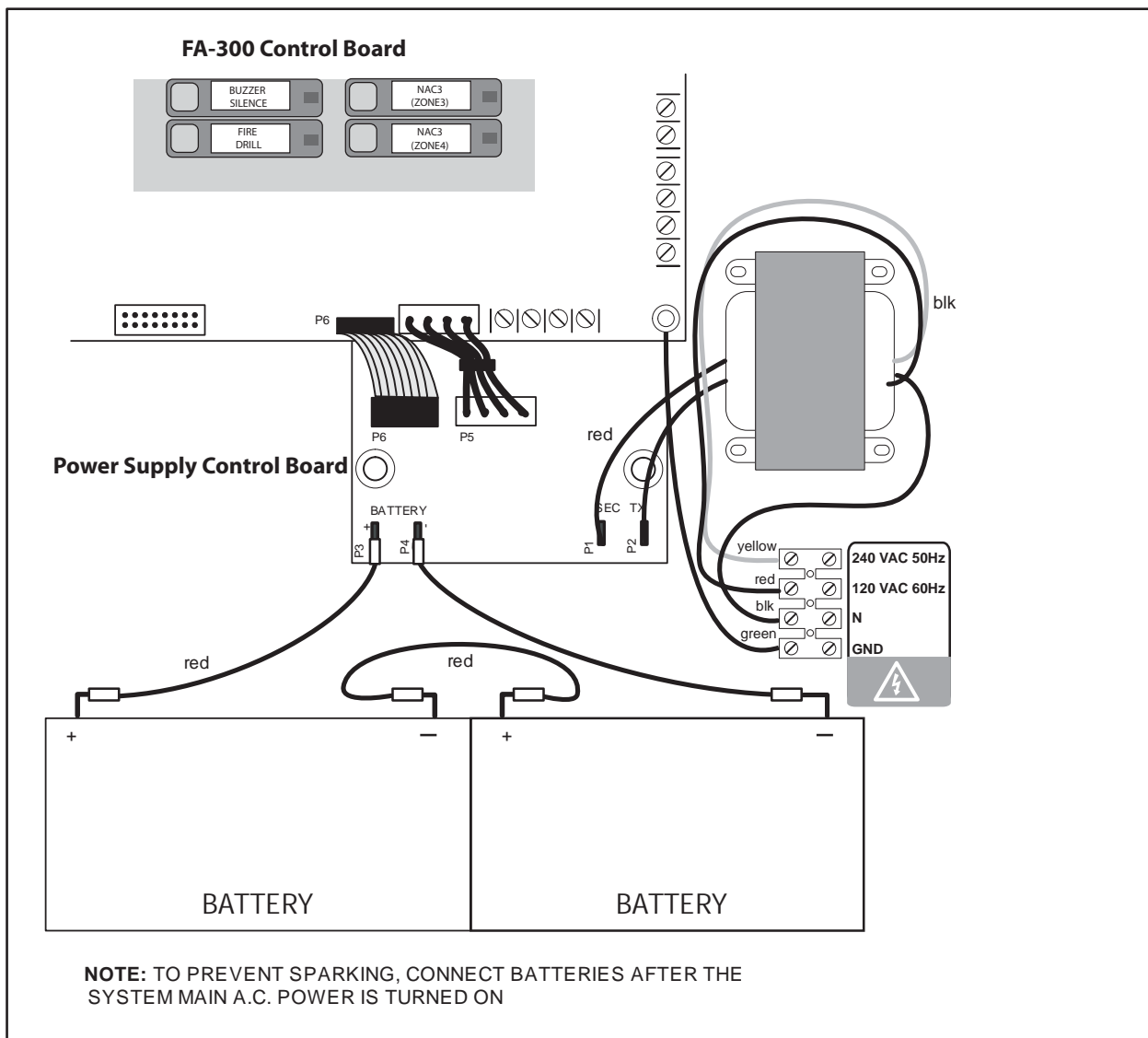

Wiring Tables and Information

Table 3: Initiating Circuit Wiring

Wire gauge AWG	Maximum wiring run to last device	
	Feet	Meters
22	2990	910
20	4760	1450
18	7560	2300
16	12000	3600
14	19000	5800
12	30400	9200



Notes:

- For Class A the maximum wiring run to the last device is divided by two.
- Maximum loop resistance should not exceed 100 ohms.
- Maximum capacitance of 0.5uF total on each initiating circuit.

Table 4: Indicating Circuit Wiring

Total signal load in amperes	Maximum wiring run to last device								Max. loop resistance in ohms
	18 AWG		16 AWG		14 AWG		12 AWG		
	Feet	Meters	Feet	Meters	Feet	Meters	Feet	Meters	
0.06	2350	716	3750	1143	6000	1829	8500	2591	30
0.12	1180	360	1850	567	3000	915	4250	1296	15
0.30	470	143	750	229	1200	366	1900	579	6
0.60	235	71	375	114	600	183	850	259	3
0.90	156	47	250	76	400	122	570	174	2
1.20	118	36	185	56	300	91	425	129	1.5
1.50	94	29	150	46	240	73	343	105	1.2
1.70	78	24	125	38	200	61	285	87	1.0



Notes:

- For Class A wiring the resistance in ohms is multiplied by two.
- Maximum voltage drop should not exceed 1.8 volts.

Four-Wire Smoke Power (regulated)

4-wire smoke power is provided for 4-wire smoke detectors. This filtered supply is supervised therefore a short will disconnect the power through the relay until the "RESET" key is pressed. A trouble signal will be generated once there is a short. This supply is rated at 22.3VDC regulated/300mA max/1V voltage drop maximum.

Supervised Auxiliary Power (regulated)

Supervised auxiliary power is used to power the remote annunciators and smart relay modules. This filtered circuit is supervised therefore a short will disconnect the power through the relay until the "RESET" key is pressed. A trouble signal will be generated once there is a short. This supply is rated at 22.3VDC regulated/500mA max/1V voltage drop maximum.

Auxiliary Power (unfiltered)

This unfiltered supply is not supervised. This supply is rated at 24VDC FWR/1.7A max. If there is a short on this circuit, the auxiliary power does not recover automatically when the short is removed. The main power must be disconnected, then reconnected and the panel reset to re-establish the auxiliary power supply.

System Checkout

Before turning the power “ON”

To prevent sparking, **do not connect** the batteries. Connect the batteries after powering the system from the main AC supply.

1. Check that all modules are installed in the proper location with the proper connections.
2. Check all field (external) wiring for opens, shorts, and ground.
3. Check that all interconnection cables are secure, and that all connectors are plugged in properly.
4. Check all jumpers and switches for proper setting.
5. Check the AC power wiring for proper connection.
6. Check that the chassis is connected to **EARTH GROUND** (cold water pipe).
7. Make sure to **close the front cover plate** before powering the system from main AC supply.

The best way to set up a panel for the first time is to avoid connecting any field wiring at first. To begin set up, power up the panel with an end of line resistor. The panel should be free of trouble. If the panel is free of trouble, connect one circuit at a time, checking for troubles each time. If a trouble occurs at any point during the setup, correct the fault, then continue the field wiring.

Power-up procedure

After completing the System Checkout procedures outlined above,

8. Power up the panel. The "AC-ON" green LED and the “Common Trouble” LED should illuminate, and the buzzer should sound. Press the “System Reset” button. Since the batteries are not connected, the trouble buzzer should sound intermittently and the common trouble LED should flash.
9. Connect the batteries while observing correct polarity: the red wire is positive (+) and black wire is negative (-). All indicators should be OFF except for normal power "AC ON" green LED and green LED I4 (located at the left bottom of panel, near the trouble relay).



Note: Green LED I4 is illuminated when the system is normal. This LED indicates that the trouble relay is in normal standby condition.

10. Configure the Fire Alarm Control Panel as described in the Configuration section.

Troubleshooting

Symptoms	Possible Cause
Circuit Trouble	Normally when a circuit trouble occurs, its designated trouble indicator will be illuminated, as well as the common trouble indicator and trouble buzzer. To correct the fault, check for open wiring on that particular circuit loop or that the Circuit Disconnect Switch is in the ON or CLOSED position. <i>Note: Disconnecting a Circuit will cause a system trouble (off-normal position).</i>
Remote Trouble	Remote Trouble will be indicated on the main panel display for any failure reported by, or failure to communicate with a remote annunciator or other remote device.
Ground Fault	This panel has a common ground fault detector . To correct the fault, check for any external wiring touching the chassis or other Earth Ground connection.
Battery Trouble	Check for the presence of batteries and their conditions. Low voltage (below 20.4V) will cause a battery trouble. If battery trouble condition persists, replace batteries as soon as possible.
Walk Test Mode	If the Walk Test LED is illuminated steadily, the system is in Walk Test Mode.
Common Trouble	If only a common trouble is indicated on the main panel and none of the above confirming trouble indicators are on, check the following for possible fault: <ul style="list-style-type: none"> • Check for any missing interconnection wiring. • Check for any Module missing that was part of the Configuration. • Check for improperly secured cabling.

Indicators, Controls and Operations

Refer to *Figure 18* below for LED Indicator and Control Button locations.

Figure 18: LED indicators and control buttons

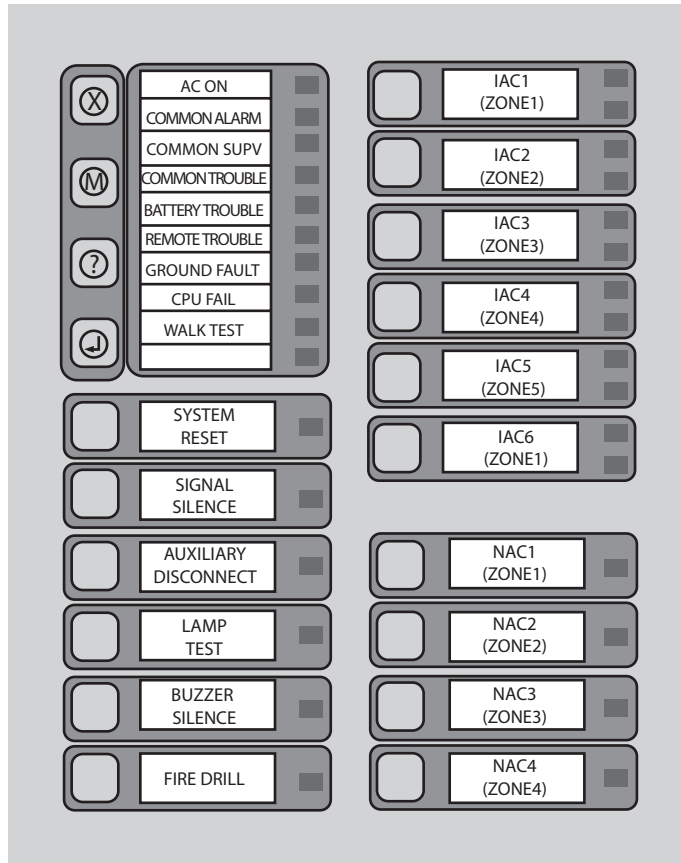

The Main Display Panel on the Main Fire Alarm Control Board consists of:

- 15 common LED Indicators (left half of the display)
- 10 Common Buttons (left half of the display)
- up to six Initiating Circuit Alarm LEDs and six Initiating Circuit Trouble LED Indicators
- Four Indicating Circuit LEDs (labeled NAC- Notifying Appliance Circuit)
- up to ten disconnect buttons (six for initiating circuit & four for indicating circuits)

LED Indicators may be Amber, Red, or Green, and may illuminate continuously (steady), or at one of two Flash Rates.

- Fast Flash (Supervisory) - 120 flashes per minute, 50% duty cycle
- Trouble Flash (Trouble)- 20 flashes per minute, 50% duty cycle

Note that each display is supplied with laser printer printable paper labels for sliding into the plastic label template on the panel. For the Main Display, the paper label is **Mircom# NP-2057**; this includes English and French versions.

Common Indicators

Buzzer

The Buzzer is activated by any of the following events:

Fire Alarm:	Steady
Supervisory Alarm:	Fast Flash
Trouble:	Trouble Flash Rate

If the Buzzer is turned on in response to a Non-Latching Trouble or Supervisory, it will be turned off if the condition causing it goes away and there is no other reason for it to be on.

AC ON LED

The green AC ON Indicator will steadily illuminate as long as the main AC power is above minimum level. The indicator turns OFF when the level falls below the power-fail threshold and the panel is switched to standby (battery) power.

Common Alarm LED

The red Common Alarm Indicator steadily illuminates whenever the panel alarms on any initiating circuit. Since all alarms are latched until the panel is reset, the Indicator will remain ON until then.

Common Supervisory LED

The amber Common Supervisory Indicator turns ON steady when there is a Supervisory Alarm in the Panel caused by any Latching or Non-Latching Supervisory Circuit. The Indicator is turned OFF when all Non-Latching Supervisory Circuits are restored and there are no active Latching Supervisory Circuits. Latching Supervisory Alarms remain active until the Panel is reset.

Common Trouble LED

The amber Common Trouble Indicator turns ON steady when the panel detects any trouble condition. It turns OFF when all Non-Latching Troubles are cleared.

Remote Trouble LED

The amber Remote Trouble Indicator flashes at the Trouble Flash Rate if there is trouble detected at a City Tie or DACT, or if there is communication trouble detected with a Remote Annunciator or if a Remote Annunciator reports a local trouble. It is turned off if these conditions go away.

Fire Drill LED

The amber Fire Drill Indicator illuminates steadily while Fire Drill is active.

Walk Test LED

The amber Walk Test Indicator illuminates steadily to indicate that the panel is in Walk Test Mode. If the Panel is left in this mode for over an hour with no operator activity, the panel will return to normal and the Walk Test indicator will turn OFF.

CPU Fail LED

The amber CPU Fail LED Indicator flashes at the Trouble Flash Rate to indicate a microprocessor failure on the main board.

Auxiliary Disconnect LED

The amber Auxiliary Disconnect Indicator flashes at the Trouble Rate when the Auxiliary Disconnect button is pressed. It turns OFF when the Auxiliary Disconnect button is pressed a second time. When ON flashing, the Auxiliary Disconnect Indicator signifies that the Auxiliary Alarm Relay is disconnected. Depending on the programming the auxiliary disconnect switch can also disconnect the common alarm and supervisory relay, see Configuration section. When the Auxiliary Disconnect LED is flashing, the trouble buzzer will also sound.

Signal Silence LED

The Signal Silence indicator flashes amber, at the trouble rate, when indication Circuits are Silenced either by the Signal Silence button, or by the Auto Signal Silence Timer. It is turned off when the Signals are re-sounded by a subsequent Alarm.

Battery Trouble LED

The amber Battery Trouble Indicator flashes at the Trouble Rate when the Battery is either low (below 20.4 VDC) or disconnected.

Ground Fault LED

The amber Ground Fault Indicator flashes at the Trouble Rate when the Ground Fault Detector detects a Ground Fault on any field wiring. It turns off when the Ground Fault is cleared.

System Reset LED

This indicator is activated for a short time when the RESET key is pressed.

Alarm Circuit Indicators

This operation applies to Initiating Circuits configured as Verified Alarm, Non-Verified Alarm, Water flow Alarm, Sprinkler Alarm, or General Alarm Circuits. The following table summarizes the indications at different events.

Event	Circuit Trouble LED	Configuration
Open circuit or (Style D)/(Class A) trouble	Flashes at the trouble rate (amber)	Verified Alarm Non-Verified Alarm
Disconnected	Flashes at the trouble rate (amber)	Water flow Alarm Sprinkler Alarm
Circuit Active	OFF	General Alarm
Event	Circuit Status LED	Configuration
Circuit Active	Steady (red)	
Pre-alarm	Fast flash rate (red)	Verified Alarm Sprinkler Alarm Water flow Alarm
Active circuit reconnected	Fast flash rate (red)	

Supervisory Circuit Indicators

This operation applies to Initiating Circuits configured as Latching or Non-Latching Supervisory Circuits. The following table summarizes the indications in response to different events

Event	Circuit Trouble LED	Configuration
Open circuit or (Style D)/(Class A) trouble	Flashes at the trouble rate (amber)	Latching Sup. Non-Latching Sup.
Disconnected	Flashes at the trouble rate (amber)	
Circuit Active	OFF	
Event	Circuit Status LED	Configuration
Circuit Active	Steady (amber)	Latching Sup.
Active circuit reconnected	Fast flash rate (amber)	Non-Latching Sup.

Monitor Circuit Indicators

This operation applies to initiating circuits configured as monitor circuits. The following table summarizes the indications in response to different events.

Event	Circuit Trouble LED	Configuration
Open circuit or (Style D)/(Class A) trouble	Flashes at the trouble rate (amber)	Monitor
Disconnected	Flashes at the trouble rate (amber)	
Circuit Active	OFF	
Event	Circuit Status LED	Configuration
Circuit Active	Steady (amber)	Monitor
Active circuit reconnected	Fast flash rate (amber)	

Trouble-only Circuit Indicators

This operation applies to initiating circuits configured as Trouble-Only Circuits. The following table summarizes the indications in response to different events.

Event	Circuit Trouble LED	Configuration
Open circuit or (Style D)/(Class A) trouble	Flashes at the trouble rate (amber)	Trouble Only
Disconnected	Flashes at the trouble rate (amber)	
Short Circuit	Flashes at the trouble rate (amber)	

Signal Circuit Indicators

This operation applies to indicating circuits of any type. The Circuit Trouble Indicator flashes amber at the Trouble Rate to indicate short-circuit or open-circuit trouble, or if the circuit is Disconnected.

Event	Circuit Trouble LED	Configuration
Open circuit	Flashes at the trouble rate (amber)	Signal
Short Circuit	Flashes at the trouble rate (amber)	
Disconnected	Flashes at the trouble rate (amber)	

Common Controls

Menu Buttons

To use the menu buttons you will need to install the CFG-300 configuration tool. See *Configuration and CFG-300 Tool* on page 32 for details.



Menu Button

Pressing  and entering the passcode will allow you to enter the command menu.



Info Button

When the system is off-normal, press  to display extra information of the event.



Enter Button

Pressing this button to select a menu option or to confirm a menu operation.



Cancel Button

To return to previous menu in the configuration or command mode.

System Reset Button

The System Reset button resets the Fire Alarm Control Panel and all Circuits. In particular, the system reset button

- Resets all Latching Trouble Conditions
- Resets all Initiating Circuits
- Resets 4-Wire Smoke Supply
- Turns off all Indicating Circuits
- Turns off Signal Silence
- Turns off Fire Drill
- Stops and resets all Timers
- Processes inputs as new events
- Does not affect Aux Disconnect

Signal Silence Button

Activation of the Signal Silence button when the panel is in alarm turns on the Signal Silence indicator and deactivates any Silenceable Indicating Circuits. Non-Silenceable Circuits are unaffected. Signals will re-sound upon any subsequent alarm. Subsequent operation of signal silence resounds all Silenceable signals. This button does not function during any configured Signal Silence Inhibit Timer period. It also does not function if the Indicating Circuits are active as the result of a Fire Drill.

Fire Drill Button

The Fire Drill button activates all Non-Disconnected Indicating Circuits, but does not transmit any Alarms via the City Tie, Common Alarm Relay or Auxiliary Alarm Relay. Fire Drill activates the signals in the evacuation code programmed. For example in the Temporal Code, the signals will be pulsed ON for 0.5 seconds, OFF for 0.5 seconds in rounds of 3 and then pause for 1.5 seconds and repeat.

Fire Drill is cancelled by pressing the button again, or if the Panel goes into a real alarm.

Auxiliary Disconnect Button

Activating the Auxiliary Disconnect button activates the Auxiliary Disconnect function. The Auxiliary Alarm Relay is always disconnected with this button. The Common Alarm Relay, the Common Supervisory relay and all correlated alarm relays may be disconnected as selected through configuration. Activating the Auxiliary Disconnect button also causes the Common Trouble LED to illuminate steady, the common trouble relay to send a trouble message and the trouble buzzer to flash at the trouble flash rate. Pressing the Auxiliary Disconnect button again de-activates this function and the system will go back to normal.

Lamp Test Button

Activation of the Lamp Test button causes all front panel Indicators to steadily illuminate and turns the buzzer ON steady. If Lamp Test is active for more than 10 seconds, Common Trouble is activated. The lamp test for CPU Fail LED is during power up.

Buzzer Silence Button

Activation of the Buzzer Silence button while the Buzzer is sounding silences the Buzzer. The Buzzer will resound if there is a subsequent event. Pressing the button when the Buzzer is not sounding has no effect.

Circuit (zone) disconnect buttons

Circuit (Zone) Disconnect pushbuttons are provided for all initiating and indicating circuits on the Fire Alarm Control Panel. These pushbuttons are located beside their respective indicating LED.

Pressing a Circuit Disconnect pushbutton bypasses the associated circuit and turns on its Trouble Indicator, activating Common Trouble. While a Circuit is disconnected, all changes in status (alarms and troubles) on that circuit are ignored. The panel does not activate disconnected indicating circuits. Circuit Disconnect pushbuttons are toggle switches; therefore, pressing an activated switch a second time will un-bypass (reconnect) the circuit.

Disconnecting an active Latching Initiating Circuit (including Alarms, Water flow Alarm, Sprinkler Alarm, General Alarm, and Latching Supervisory) does not affect its status until the panel is reset. Disconnecting an active Non-Latching Initiating Circuit (including Non-Latching Supervisory and Trouble-Only) causes them to behave as if the alarm situation has disappeared. Disconnecting an active indicating circuit immediately deactivates the circuit.

When an Initiating Circuit Disconnect pushbutton is returned to the normal state (by pressing it again in order to un-bypass the circuit), the panel checks the state of the circuit. If the bypassed input circuit is active and the Bypass Switch is pressed for un-bypassing, the Alarm LED will flash at the fast flash rate for 10 seconds. During these 10 seconds, pressing the Bypass Switch can bypass the active input circuit again. After 10 seconds, the bypassed alarm will be processed.

Disconnect pushbuttons are also used during *Walk-Test* as described in the System Checkout section.

Common Relays

Common Alarm Relay

The Common Alarm Relay activates when the common alarm sequence is activated. The common alarm relay is disconnected by aux disconnect if programmed (see Configuration section). Since all alarm conditions are latched until system reset, the relay will remain ON until the alarm is cleared and the system is reset.

Common Supervisory Relay

The Common Supervisory Relay activates when the common supervisory sequence is activated as the result of an alarm on any un-bypassed latching or non-latching supervisory circuit. The relay is turned OFF if all non-latching supervisory circuits are restored and there are no latching supervisory circuits active. The relay can be disconnected by aux disconnect if programmed (see Configuration section). The relay will function the same way as an alarm relay if the supervisory relay is disabled (see Configuration section).

Common Trouble Relay

The Common Trouble relay is activated when the common trouble sequence is activated as the result of the trouble condition being detected on the system. It is turned off when all troubles are cleared.



Note: Some troubles are latching once they are detected they remain active until system reset. In this case the common trouble indicator will also remain active until system reset. The common trouble is not bypassed by the auxiliary disconnect function.

Auxiliary Alarm Relay

The Auxiliary Alarm Relay functions the same way as the Common Alarm Relay in every respect except that it can be disconnected by auxiliary disconnect with or without other correlated relays if it is programmed to do so (see Configuration section). When configured (see Configuration section), the relay can also be disconnected if signal silence is active and reconnected if signal silence is de-activated.

Circuit Types

Initiating (Detection) Circuit Types

Non-Verified Alarm

A Non-Verified alarm is a “normal” type of alarm that can have pull stations, smoke detectors, or heat detectors attached to it. Activation of any of these devices will immediately result in an alarm condition in the Fire Alarm Control Panel. An Alarm condition causes the associated Circuit Status LED and the Common Alarm LED to illuminate red.

Verified Alarm

Verified Alarms are verified by a reset and timing procedure, and may include smoke detectors, heat detectors or pull stations. Activation of pull stations or heat detectors will result in an alarm condition in the Fire Alarm Control Panel within four seconds. Smoke detectors will be verified for a real alarm within 60 seconds, depending upon the startup time of the devices being used. If four seconds is too long a response time for pull stations, then wire them separately on a Non-Verified Alarm Circuit. An alarm condition causes the associated Circuit Status LED and the Common Alarm LED to illuminate red.

Water Flow Alarm (Water flow Sensors)

Water Flow Alarms are identical to normal Non-Verified Alarms except that any indicating circuits programmed to these circuits (all are by default) are Non-Silenceable. Also, if Water Flow Retard Operation is enabled, these circuits are sampled every one second. If ten samples are active within any 15-second interval, the Water flow Alarm is confirmed and processed. An alarm condition causes the associated Circuit Status LED and the Common Alarm LED to illuminate red.



Note: Do not use Retard Operation with any external retarding device; maximum retard may not exceed 120 seconds.

Sprinkler Alarm (for Sprinkler Flow Sensors)

Sprinkler Alarms are identical to normal Non-Verified Alarms unless Water flow retard operation is enabled. If Water Flow Retard Operation is enabled, then these circuits are sampled every one second. If ten samples are active within any 15-second interval, the Sprinkler Alarm is confirmed and processed. An Alarm condition causes the associated Circuit Status LED and the Common Alarm LED to illuminate red.



Note: Do not use Retard Operation with any external retarding device; maximum retard may not exceed 120 seconds.

Non-Latching Supervisory (For Supervisory Circuits)

Activation on these circuits will cause the Circuit Status LED and the amber Common Supervisory LED to illuminate. The buzzer will sound at fast rate. If the circuit activation is removed, the Supervisory condition will clear (as long as there are no other Supervisory conditions in the system) and the Circuit Status LED will turn off.

Latching Supervisory (For Supervisory Devices)

Activation on these circuits will cause the Circuit Status LED and the amber Common Supervisory LED to illuminate. The buzzer will sound at fast rate. If the circuit activation is removed, the Supervisory condition will NOT clear.

Monitor

This is a supervised general-purpose non-latching input used mainly for correlating to a relay circuit. No other system condition occurs as a result of its activation (short-circuit), although it is supervised for Trouble (open-circuit).

Trouble-Only

The Trouble-Only circuit monitors a Trouble Condition from an external device such as QX-5000 Audio System. Both open and short circuits generate a non-latching Trouble condition.

Indicating (Signal) Circuits Types

Silenceable Signal

The Silenceable Signal circuit is used for audible devices such as bells and piezo mini-horns that may be silenced either manually or automatically. While sounding, these devices follow the pattern appropriate for the condition: the configured Evacuation Code (default is Temporal Code) during Single-Stage Alarm.

Non-Silenceable Signal

The Non-Silenceable Signal Circuit is used for audible devices such as bells and piezo mini-horns that may **not** be silenced either manually or automatically. While sounding, these devices follow the pattern appropriate for the condition: the configured Evacuation Code (default is Temporal Code) during Single-Stage Alarm.

Silenceable Strobe

Silenceable strobes will be silenced when the "signal silence" key is pressed. For synchronous strobes see *supported protocol/devices* section. *(NB: Strobes do not support any code pattern.)*

Non-Silenceable Strobes

Non-Silenceable Strobes will not be silenced when the "signal silence" key is pressed. For synchronous strobes see *supported protocol/devices* section. *(NB: Strobes do not support any code pattern.)*

Evacuation codes

Single stage codes

Continuous	On 100% of the time
Temporal Code	3 of 0.5 second on, 0.5 second off then, 1.5 second pause
March Code	0.5 second on, 0.5 second off
California Code	5 seconds on, 10 seconds off

Two-step codes

Alert Code	0.5 second on, 2.5 seconds off
General Alarm	Evacuation Code as selected from above.

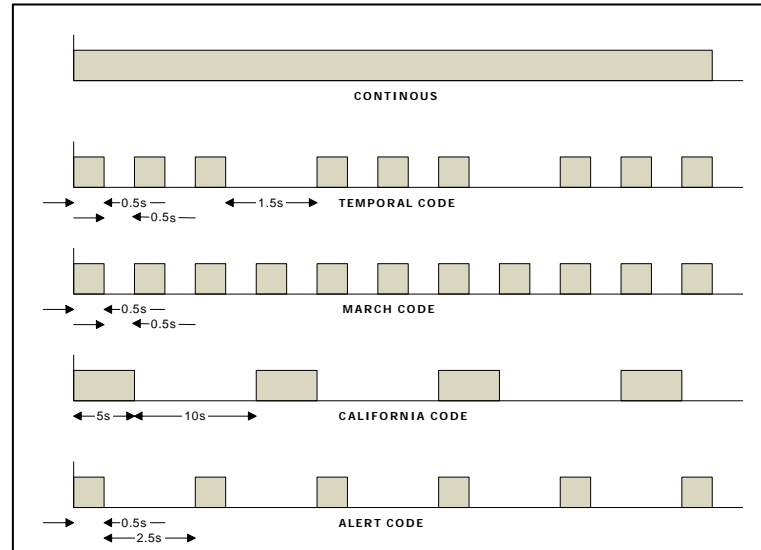
Figure 19: Evacuation and Alert Codes

Single Stage Operation

In a single stage system all alarm inputs are treated in a similar manner. Alarm inputs include any of the following: Non-Verified Alarm, Verified Alarm, Sprinkler Alarm, Water flow Alarm, and General Alarm Circuits. If any of these alarm inputs occur when the panel is not already in alarm, the following occurs:

- The Buzzer sounds steadily
- If Fire Drill is active, it is cancelled
- The Common Alarm Indicator turns on
- The Common Alarm, Auxiliary Alarm and all correlated relays will activate if Aux Disconnect is not active
- The Auto Signal Silence Timer, if configured, starts
- The Signal Silence Inhibit Timer, if configured, starts
- All connected relays programmed to the input are activated (provided that Aux Disconnect is not active)
- Non-disconnected strobes associated with the input are activated
- Non-disconnected signals associated with the input are activated at the evacuation rate

Subsequent alarms when the panel is already in alarm cause the following:

- The alert buzzer sounds steadily
- If Signals have been silenced as a result of the Signal Silence button or the Auto Signal Silence Timer, Signals are resounded as they were before Signal Silence, the Signal Silence Indicator is turned off, and the Auto Signal Silence Timer, if configured, is restarted
- Any additional non-disconnected strobes associated with the new input are activated continuously
- Any additional non-disconnected signals associated with the new input are activated at the evacuation rate

Supported Protocols/Devices

Synchronous Strobes

The synchronous strobe models that are supported by the FA-300 panel include Mircom models FHS-240 and FS-240. A separate compatibility list is available for different supported models (LT-1007).

Strobes can be configured as normal (e.g. not synchronized or any of the above; *see configuration section*). Any selection made is system-wide (e.g. whatever is selected applies to all the circuits in the system, configured as strobes).

“Signal silence” action on strobes

The “signal silence” action on strobes depends upon the configuration. The following describes the signal silence action on non-silenceable and silenceable strobes.

Non Silenceable strobe

If the output zone is configured as Non-Silenceable Strobe and if the “signal silence” is active on the panel while the strobes are active, the horn should be silenced. If the signal is active again the panel will activate the horn again.

Silenceable strobe`

If the output circuit is configured as Silenceable Strobe, and if the “signal silence” is active on the panel, both the horn and strobe are completely turned off by turning off the output circuit. Re-activating the “signal silence” will turn them on again.



Note: Please see the strobes manufacturer’s data for details.

System Sensor’s i³ Devices

The FA-300 fire control panels support System Sensor’s i³ devices. Only the two wire smoke detectors are supported on the i³ zone, which are 2W-B and 2WT-B. Model 2WT-B features a build in fixed temperature (135F / 57.2C) thermal detector and is capable of sensing a freeze condition i.e. if the temperature is below 41F / 5 C.

The zones should be programmed to i³ devices to be considered as i³ zone (*see configuration section*). If the zone is not programmed as i³ zone and i³ devices are connected to the zone, it is simply treated as a regular zone. The panel is capable of detecting multiple troubles; if different devices have different troubles on the same zone, all troubles will be reported. The following troubles are reported for the i³ devices.

i³ zone Troubles

The following troubles can be reported for a zone configured as i³ zone:

- Open circuit trouble
- Communication trouble
- High Maintenance and Low Maintenance (Out of sensitivity: defective or dirty device)
- Freeze trouble

Open circuit trouble

If the loop is broken the panel shows open loop trouble. The panel can still communicate with the devices depending upon where the open occurs.

Zone-1	
Trouble Open	1/1

Communication Trouble

If there is a fault in the line or the line is too noisy, the panel cannot communicate with the devices. The panel shows a communication trouble in this case.

Zone-1	
Communic. Trb	1/1

High Maintenance trouble

A High Maintenance trouble means that one or more units on the i3 zone have exceeded the high sensitivity limit and are vulnerable to false alarms. The unit does not need to be serviced immediately, but should be cleaned out at the earliest possible time.

Zone-1	
H-Maint Trb	1/1

Low Maintenance trouble

A Low Maintenance trouble means that one or more units on the i3 zone have exceeded the low sensitivity limit and their ability to detect smoke is compromised. **The unit should be serviced immediately.**

Zone-1	
L-Maint Trb	1/1

Freeze trouble

If the device has detected a freeze condition, (e.g. the temperature is below 41F / 5 C) then the panel will show a freeze trouble. Only model 2WT-B is capable of thermal detection; model 2W-B does not indicate any freeze trouble.

Zone-1	
Freeze Trb.	1/1

The LEDs on the i³ smoke detectors provide a local visual indication of the detector status.

The smoke detector LED status should be confirmed with the panel, since High and Low Maintenance Troubles have the same LED indication on the detector and the only way to distinguish between the two is to use the CFG-300 Configuration Tool and check the log messages as noted above.

i ³ Detector Condition	Green LED	Red LED
Power-up	Blinks every 10 sec	Blinks every 10 sec
Normal (Standby)	Blinks every 5 sec	OFF
High or Low Maintenance (Out of sensitivity: defective or dirty)	OFF	Blinks every 5 sec
Freeze trouble	OFF	Blinks every 10 sec
Alarm	OFF	Solid

Configuration and CFG-300 LCD Service Tool

There are three methods of configuring the FA-300 LED Series Fire Alarm Panels:

1. Using the CFG-300 LCD Tool (see further documentation packaged with CFG-300 for configuration information).
2. Using a PC or Lap Top Computer with a UIMA converter module.
3. Using a PC or laptop computer with remote connection (must use fire alarm with built-in UDACT).

The following information for configuring an FA-300 LED Series Fire Alarm Panel is based on using CFG-300 LCD service tool for configuration.

To access configuration mode using a CFG-300 tool, connect the CFG-300 and then press the Menu button. The CFG-300 LCD display will display the Main Menu. The function of different buttons on the front panel display is shown in *Figure 20*, below.

Figure 20: FA-300 Configuration

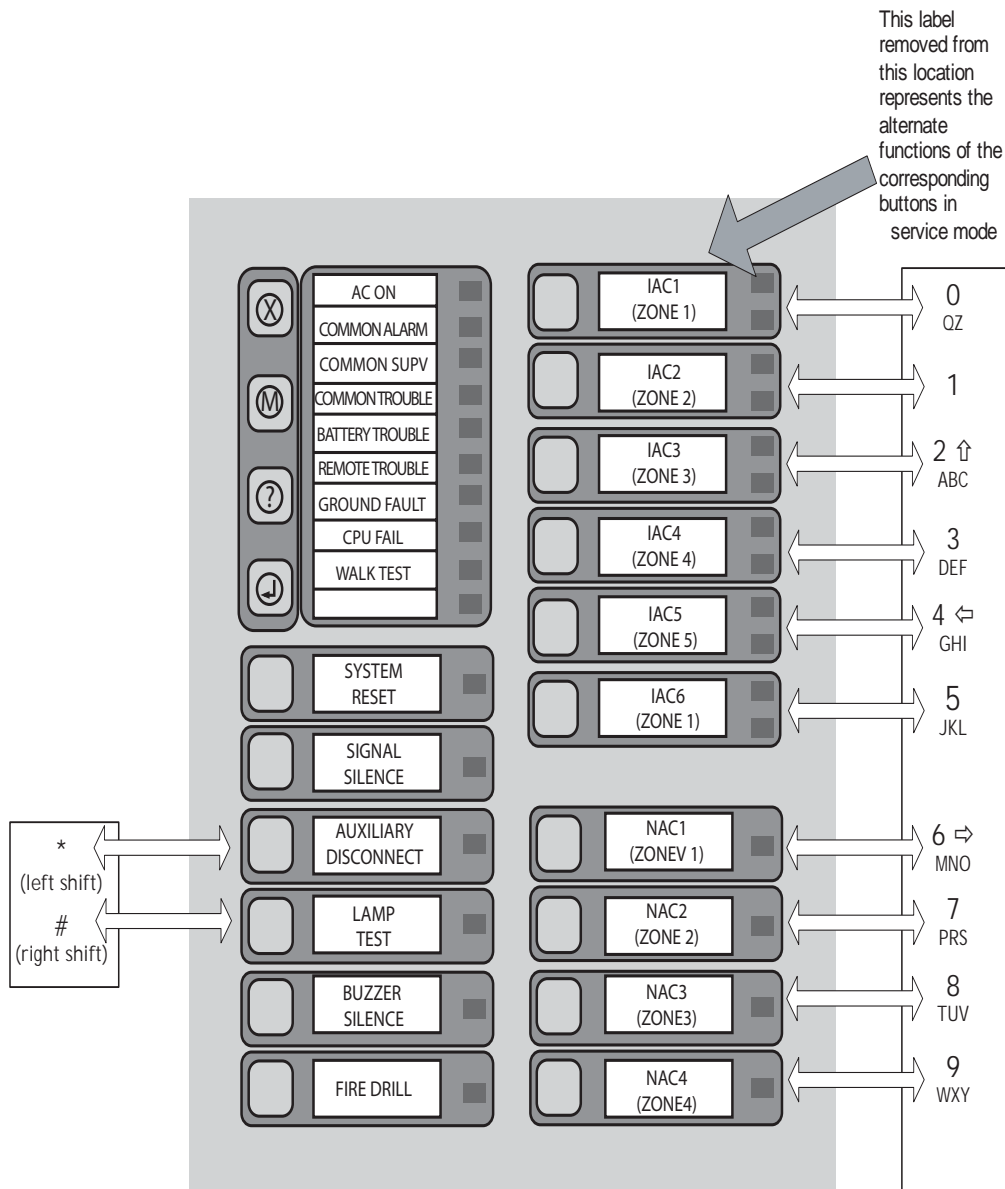

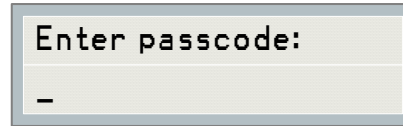

Entering the Passcode

The programming section is passcode protected. The following screen shows the message that is displayed to enter the passcode. The maximum allowable passcode is ten digits long, and permits numerical values only. Press the  (Enter button) key after entering the passcode. If the passcode is right, it will take you to the main command menu. If the passcode is wrong the system will ask you to re-enter passcode. The system will be exhausted after three retries and will then take you back to the Normal message display. The default password is "1111" (without quotes).



Command Menu

The main command menu is pictured below. The first line of the LCD will always show "-Command Menu-", and the second line scrolls through different selections. Use the "UP" and "DOWN" keys to scroll through the menu, and press  to make a selection. To exit from the main command menu, select the "Exit" menu option and then press either  or .



Note: Command Menu features 1 and 9 can only be accessed if jumper JW6 is placed on the main board, see Table 1.

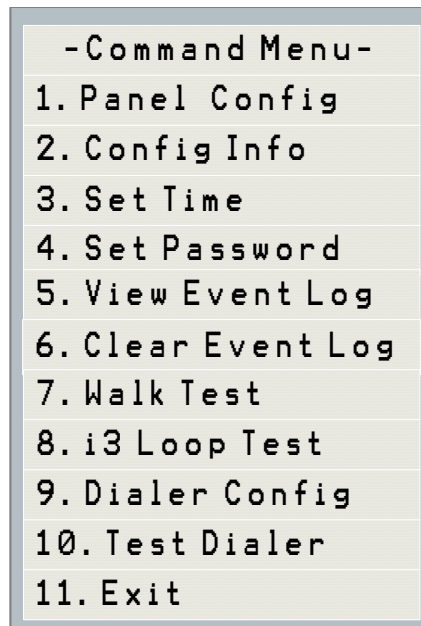



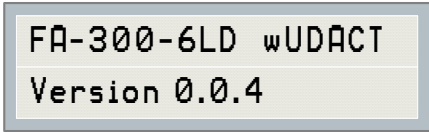



Pressing “LAMP TEST” at any time will show the information about the system and the software version as shown below.



The first line shows the model number and panel type and the second line shows the software version number. The version of the software is read as Major.Minor.Revision.

How to Use the Keypad to Program the FA-300

1. Press  (Menu button). You will be prompted to enter your password.
2. Enter your password, then press  (Enter button) to continue.
3. Select a Command Menu option by pressing . The corresponding submenu will display.
4. Use the up and down arrow buttons to scroll through the submenu.
5. Press  to select a submenu option.
6. Use the left or right arrow buttons to select/unselect an option (selected = “X”). Use the up and down arrows to scroll through the different menu options. When entering numerical data, use the up and down arrows to increase or decrease the number.
7. Once you have made the correct selection, press  to confirm the change. The display will return to the submenu screen. Press  (Cancel button) to return to the previous menu.

1. PANEL CONFIG (Command-Menu)

The following is a detailed description of the FA-300 configuration menu.

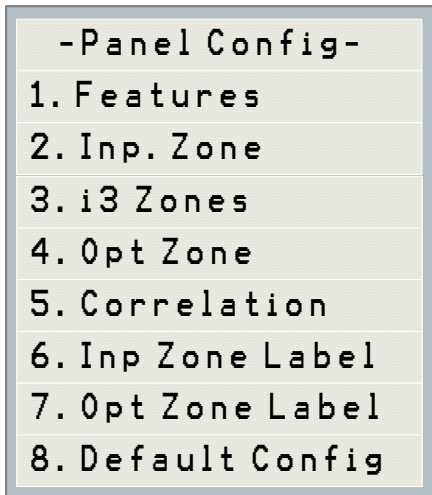

Command Menu/Panel Config-->Features

- Feature Config-
- 1. Man. Sig. Sil
- 2. Fire Drill
- 3. Opt. Ckt. Corr
- 4. Wtr/Sprk. Retd
- 5. Aux Dis Corr
- 6. Sig-Sil Inh Tm
- 7. Aux Dis, Alm&Sup
- 8. Auto Sil. Tmr
- 9. Rem. Annun.
- 10. Alm. Zmit-Sil.
- 11. Pwr Fail Tmr.
- 12. Com. Supv. Rly
- 13. Sig-Sil. Isol.
- 14. Strobe Type
- 15. Evac. Code
- 16. Active EOL
- 17. Verify. Alarm

<p>Command Menu/Panel Config/Features/ 1. Manual Signal Silence</p> <div style="border: 1px solid black; padding: 5px; margin-top: 10px;"> <p>Manual Sig. Silence [X] ENABLE</p> </div>	<p>[X] ENABLE->Default [] DISABLE</p>	<p>Use this function to enable or disable the SIGNAL SILENCE operation from the front panel.</p>
<p>Command Menu/Panel Config/Features/ 2.Fire Drill</p> <div style="border: 1px solid black; padding: 5px; margin-top: 10px;"> <p>Fire Drill [X] ENABLE</p> </div>	<p>[X] ENABLE ->Default [] DISABLE</p>	<p>Use this function to enable or disable the FIRE DRILL operation.</p>

<p>Command Menu/Panel Config/Features/ 3.Output Circuit Correlation</p> <pre>Opt. Ckt. Corr. [X] DISABLE</pre>	<p><input checked="" type="checkbox"/> DISABLE->Default <input type="checkbox"/> ENABLE</p>	<p>If disabled, whatever correlation is set in the correlation section is effective. If enabled, all the output circuits are correlated to all the input circuits.</p>
<p>Command Menu/Panel Config/Features/ 4.Waterflow/Sprinkler Retard Operation</p> <pre>Waterflow/Sprk. Retd [X] DISABLE</pre>	<p><input checked="" type="checkbox"/> DISABL ->Default <input type="checkbox"/> ENABLE</p>	<p>If disabled, all the initiating circuits configured as water flow or sprinkler act as non-verified alarms. If enabled, retard operation is performed for initiating circuits configured as water flow or sprinkler. <i>(See Water flow Alarm and Sprinkler Alarm description)</i></p>
<p>Command Menu/Panel Config/Features/ 5.Aux. disconnect, disconnects Aux Alarm relay and all correlated relays</p> <pre>Aux Dis Corr [X] DISABLE</pre>	<p><input type="checkbox"/> ENABLE <input checked="" type="checkbox"/> DISABLE->Default</p>	<p>In the default mode this function will disconnect the Auxiliary Alarm Relay when selected by the Aux Disconnect button. If enabled, this function will disconnect the Auxiliary Alarm Relay <u>and</u> all correlated relays by pressing the Aux Disconnect button. Correlated relays include: RM-306 relays, SRM-312 relays.</p>
<p>Command Menu/Panel Config/Features/ 6.Signal-Silence Inhibit timer</p> <pre>Sig-Sil. Inhibit Tmr [X] DISABLE</pre>	<p><input checked="" type="checkbox"/> DISABLE->Default <input type="checkbox"/> 10 SEC <input type="checkbox"/> 20 SEC <input type="checkbox"/> 30 SEC <input type="checkbox"/> 1 MIN</p>	<p>Use this function to inhibit the "SIGNAL SILENCE" switch for a desired length of time. This time period should expire before the signals may be silenced. According to the Canadian National Building Code, this timer should be set to one minute.</p>
<p>Command Menu/Panel Config/Features/ 7. Aux. disconnect, disconnects common alarm relay and common supervisory relay</p> <pre>Aux Dis,Dis Alm&Spv [X] DISABLE</pre>	<p><input type="checkbox"/> ENABLE <input checked="" type="checkbox"/> DISABLE->Default</p>	<p>If enabled, this function will disconnect (when the Aux. disconnect switch is pressed) the Common Alarm relay and Common Supervisory relay and the PR-300 will not transmit a supervisory or alarm event. If disabled, the Aux disconnect switch has no effect on the Common Alarm relay, the Common Supervisory relay and the PR-300.</p>
<p>Command Menu/Panel Config/Features/ 8.Auto Signal Silence Timer</p> <pre>Auto Sig-Sil. Timer [X] DISABLE</pre>	<p><input checked="" type="checkbox"/> DISABLE->Default <input type="checkbox"/> 5 Min <input type="checkbox"/> 10 Min <input type="checkbox"/> 15 Min <input type="checkbox"/> 20 Min <input type="checkbox"/> 30 Min</p>	<p>Use this function to determine the time period for which the indicating circuits will sound before they are automatically silenced. According to the Canadian National Building Code, this timer should not be set to less than 20 minutes.</p>

<p>Command Menu/Panel Config/Features/ 9. Number of Remote Annunciators or smart relays</p> <pre>No. of Remote Annun. [X] NONE</pre>	<pre>[X] NONE->Default [] 1 [] 2 [] 3 [] 4 [] 5 [] 6</pre>	<p>Use this function to program the number of remote annunciators. Any combination of remote annunciators or smart relays can be used as long as the number does not exceed 6. The annunciators' addresses should be linear: without gaps and in sequence.</p>
<p>Command Menu/Panel Config/Features/ 10.Silence Alarm transmit</p> <pre>Alm. Xmit-Sil. [X] DISABLE</pre>	<pre>[X] DISABLE->Default [] ENABLE</pre>	<p>Use this function to allow the alarm transmits and auxiliary alarm relay to reset on "SIGNAL SILENCE" rather than the "RESET" switch.</p>
<p>Command Menu/Panel Config/Features/ 11.AC power fail delay timer</p> <pre>AC Pwr Fail Dly Tmr. [X] NONE</pre>	<pre>[X] NONE ->Default [] 1 HRS [] 2 HRS [] 3 HRS</pre>	<p>Use this function to place a timed delay on reporting the AC power fail trouble externally via common trouble relay. If this problem corrects itself within the specified time, the common trouble relay will not be activated. If disabled, the trouble relay is activated immediately.</p>
<p>Command Menu/Panel Config/Features/ 12.Common Supervisory Relay</p> <pre>Common Supv. Relay [X] DISABLE</pre>	<pre>[] ENABLE [X] DISABLE ->Default</pre>	<p>If enabled, the common supervisory relay can be used as common alarm relay. It will act the same way as a common alarm relay. If disabled, it is used a common supervisory relay.</p>
<p>Command Menu/Panel Config/Features/ 13.Signal Isolators</p> <pre>Sig-Sil. Isolator [X] DISABLE</pre>	<pre>[] ENABLE [X] DISABLE->Default</pre>	<p>Enable this function only when suite isolators are used (Canada only)</p>
<p>Command Menu/Panel Config/Features/ 14.Strobe Type</p> <pre>Strobe Type [X] NORMAL</pre>	<pre>[X] NORMAL ->Default [] MIRCOM [] FARADY [] WHEELLOCK [] GENTEX [] SYSTEM SENSOR</pre>	<p>Use this function to select the manufacturer of the strobes used in the system. The selection is system-wide and applies to all indicating circuits configured as strobes. For "NORMAL" strobes there is no synchronization, while other strobes are synchronized and use manufacturer's protocol to synchronize the strobes.</p>
<p>Command Menu/Panel Config/Features/ 15.Evacuation Code</p> <pre>Evacuation Code [X] TEMPORAL</pre>	<pre>[X] TEMPORAL->Default [] CONTINUOUS [] MARCH TIME [] CALIFORNIA</pre>	<p>Use this function to set the rate at which the indicating circuits will sound.</p>

<p>Command Menu/Panel Config/Features/ 16. Active EOL</p> <div style="border: 1px solid gray; padding: 5px;"> <p>Active EOL <input checked="" type="checkbox"/> DISABLE</p> </div>	<p><input checked="" type="checkbox"/> DISABLE->Default <input type="checkbox"/> NO</p>	<p>Enable this function if using an Active EOL. If ICAC-306 is used, this function should be enabled since the Class A Converter has built in Active EOL resistors.</p>
<p>Command Menu/Panel Config/Features/ 17. Verify. Alarm</p> <div style="border: 1px solid gray; padding: 5px;"> <p>Alarm verification <input checked="" type="checkbox"/> ULC</p> </div>	<p><input checked="" type="checkbox"/> ULC->Default <input type="checkbox"/> ULI</p>	<p>Select alarm verification timing according to ULI or ULC standard.</p>

Command Menu-->Panel Config



Note: Refer to *How to Use the Keypad to Program the FA-300* on page 34 for detailed instructions on making menu selections.

Inp Zone

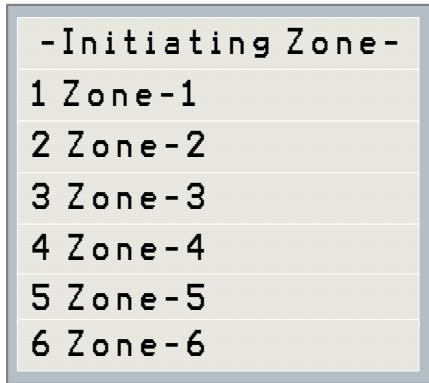

This **Inp Zone** menu is used to program the process type for the initiating circuits. Only six circuits will be shown for models FA-300-6LD and FA-300-6L.

<p>Command Menu/Panel Config/lpt. Zone 1.Process Type (Initiating circuit)</p> <div style="border: 1px solid gray; padding: 5px;"> <p>Zone-1 Type <input checked="" type="checkbox"/> ALARM</p> </div> <p>6.</p> <div style="border: 1px solid gray; padding: 5px;"> <p>Zone-6 <input checked="" type="checkbox"/> ALARM</p> </div>	<p><input checked="" type="checkbox"/> ALARM ->Default <input type="checkbox"/> VERIF ALARM <input type="checkbox"/> SPRKL ALM <input type="checkbox"/> WTR-FLOW ALM <input type="checkbox"/> NON-LATCH SUP <input type="checkbox"/> LATCH SUPV <input type="checkbox"/> MONITOR <input type="checkbox"/> TRB ONLY</p>	<p>Use this function to program the process type of each input zone. (See <i>CIRCUIT TYPE</i> section for details.)</p>
--	--	---

Command Menu-->Panel Config



Note: Refer to *How to Use the Keypad to Program the FA-300* on page 34 for detailed instructions on making menu selections.

i3 Zones

This **i3 Zones** menu is used to program the process type for the initiating circuits. Select the zone to be an i3 zone, otherwise the panel will treat the zone as a normal detection zone. Only six circuits will be shown for models FA-300-6LD and FA-300-6L..

<div style="border: 1px solid gray; padding: 5px; background-color: #f0f0f0;"> <p style="text-align: center;">-i3 Detection Zones-</p> <p>1 [] Zone-1</p> <p>2 [] Zone-2</p> <p>3 [] Zone-3</p> <p>4 [] Zone-4</p> <p>5 [] Zone-5</p> <p>6 [] Zone-6</p> </div>	<pre>[] Zone-1 ->Default - - - - [] Zone-6 ->Default</pre>	<p>Use this function if i3 devices are present on a zone. (See i3 devices section for details).</p>
---	--	---

Command Menu-->Panel Config



Note: Refer to *How to Use the Keypad to Program the FA-300* on page 34 for detailed instructions on making menu selections.

Opt Zone

Indicating Zone
1 NAC-1
2 NAC-2
3 NAC-3
4 NAC-4

This menu is used to program the process type of the indicating circuits.

<p>Command Menu/Panel Config/Opt. Zone</p> <p>1.Process Type (Indicating Circuits)</p> <table border="1"> <tr> <td>NAC-1 Type</td> </tr> <tr> <td><input checked="" type="checkbox"/> SIL-ABLE</td> </tr> </table> <p>4.</p> <table border="1"> <tr> <td>NAC-4 Type</td> </tr> <tr> <td><input checked="" type="checkbox"/> Sil-able</td> </tr> </table>	NAC-1 Type	<input checked="" type="checkbox"/> SIL-ABLE	NAC-4 Type	<input checked="" type="checkbox"/> Sil-able	<p><input checked="" type="checkbox"/> SIL-ABLE->Default</p> <p><input type="checkbox"/> NON SIL-ABLE</p> <p><input type="checkbox"/> SIL-ABLE STR</p> <p><input type="checkbox"/> NON-SIL STR</p>	<p>Use this function to program the process type of each indicating circuit. See <i>CIRCUIT TYPE</i> section for details.</p>
NAC-1 Type						
<input checked="" type="checkbox"/> SIL-ABLE						
NAC-4 Type						
<input checked="" type="checkbox"/> Sil-able						

Command Menu-->Panel Config

Correlation

<p>Command Menu/Panel Config/Correlation</p> <p>1.Correlation</p> <table border="1"> <tr> <td>Zone-1 Corr.</td> </tr> <tr> <td><input checked="" type="checkbox"/> NAC-1</td> </tr> </table> <p>6.</p> <table border="1"> <tr> <td>Zone-6 Corr.</td> </tr> <tr> <td><input checked="" type="checkbox"/> NAC-1</td> </tr> </table>	Zone-1 Corr.	<input checked="" type="checkbox"/> NAC-1	Zone-6 Corr.	<input checked="" type="checkbox"/> NAC-1	<p><input checked="" type="checkbox"/> NAC-1 ->Default</p> <p><input checked="" type="checkbox"/> NAC-2 ->Default</p> <p><input checked="" type="checkbox"/> NAC-3 ->Default</p> <p><input checked="" type="checkbox"/> NAC-4 ->Default</p>	<p>Use this function to correlate initiating circuits to the indicating circuits. By default all the initiating circuits are correlated to all the indicating circuits.</p>
Zone-1 Corr.						
<input checked="" type="checkbox"/> NAC-1						
Zone-6 Corr.						
<input checked="" type="checkbox"/> NAC-1						

Command Menu-->Panel Config



Note: Refer to *How to Use the Keypad to Program the FA-300* on page 34 for detailed instructions on making menu selections.

Inp Zone Label

```

-Initiating Zone-
1 Zone-1
2 Zone-2
3 Zone-3
4 Zone-4
5 Zone-5
6 Zone-6
    
```

Use the keys described below for entering message. These keys are alternate functions of bypass switches and are physically located in the same position as described following.

Command Menu/ Panel Config /lpt. Zone Lab 1.Initiating zone label	[Zone-1]->Default [Zone-6]->Default																		
<pre> Zone-1 Label Zone-1 </pre>	BYPASS SWITCH TRANSLATION <table border="0"> <tr> <td>KEY SEQ 1 2 3 4</td> <td>KEY SEQ 1 2 3 4</td> </tr> <tr> <td colspan="4">-----</td> </tr> <tr> <td>Zone-1 0 Q Z</td> <td>Zone-2 1</td> </tr> <tr> <td>Zone-3 2 A B C</td> <td>Zone-4 3 D E F</td> </tr> <tr> <td>Zone-5 4 G H I</td> <td>Zone-6 5 J K L</td> </tr> <tr> <td>NAC-1 6 M N O</td> <td>NAC-2 7 P R S</td> </tr> <tr> <td>NAC-4 8 T U V</td> <td>NAC-3 9 W X Y</td> </tr> <tr> <td>Aux Disconnect</td> <td>Back Space Lamp Test Forward</td> </tr> </table>	KEY SEQ 1 2 3 4	KEY SEQ 1 2 3 4	-----				Zone-1 0 Q Z	Zone-2 1	Zone-3 2 A B C	Zone-4 3 D E F	Zone-5 4 G H I	Zone-6 5 J K L	NAC-1 6 M N O	NAC-2 7 P R S	NAC-4 8 T U V	NAC-3 9 W X Y	Aux Disconnect	Back Space Lamp Test Forward
KEY SEQ 1 2 3 4	KEY SEQ 1 2 3 4																		

Zone-1 0 Q Z	Zone-2 1																		
Zone-3 2 A B C	Zone-4 3 D E F																		
Zone-5 4 G H I	Zone-6 5 J K L																		
NAC-1 6 M N O	NAC-2 7 P R S																		
NAC-4 8 T U V	NAC-3 9 W X Y																		
Aux Disconnect	Back Space Lamp Test Forward																		
6. <pre> Zone-6 Label Zone-6 </pre>																			

Command Menu-->Panel Config



Note: Refer to *How to Use the Keypad to Program the FA-300* on page 34 for detailed instructions on making menu selections.

Opt Zone Label

```

Indicating Zone
1 NAC-1
2 NAC-2
3 NAC-3
4 NAC-4
    
```

Use the keys in described below for entering message. These keys are alternate functions of bypass switches and are physically located in the same position as described below.

<p>Command Menu/Panel Config/Opt. Zone Lab</p> <p>1.Indicating zone messages</p> <pre> NAC-1 Label SIGNAL-1 </pre> <p>4.</p> <pre> NAC-4 Label SIGNAL-4 </pre>	<pre> [NAC-1]->Default [NAC-2]->Default [NAC-3]->Default [NAC-4]->Default </pre> <hr/> <p>BYPASS SWITCH TRANSLATION</p> <table border="0"> <tr> <td>KEY SEQ 1 2 3 4</td> <td>KEY SEQ 1 2 3 4</td> </tr> <tr> <td colspan="2">-----</td> </tr> <tr> <td>Zone-1 0 Q Z</td> <td>Zone-2 1</td> </tr> <tr> <td>Zone-3 2 A B C</td> <td>Zone-4 3 D E F</td> </tr> <tr> <td>Zone-5 4 G H I</td> <td>Zone-6 5 J K L</td> </tr> <tr> <td>NAC-1 6 M N O</td> <td>NAC-2 7 P R S</td> </tr> <tr> <td>NAC-4 8 T U V</td> <td>NAC-3 9 W X Y</td> </tr> </table> <p>Aux Disconnect Back Space Lamp Test Forward</p>	KEY SEQ 1 2 3 4	KEY SEQ 1 2 3 4	-----		Zone-1 0 Q Z	Zone-2 1	Zone-3 2 A B C	Zone-4 3 D E F	Zone-5 4 G H I	Zone-6 5 J K L	NAC-1 6 M N O	NAC-2 7 P R S	NAC-4 8 T U V	NAC-3 9 W X Y
KEY SEQ 1 2 3 4	KEY SEQ 1 2 3 4														

Zone-1 0 Q Z	Zone-2 1														
Zone-3 2 A B C	Zone-4 3 D E F														
Zone-5 4 G H I	Zone-6 5 J K L														
NAC-1 6 M N O	NAC-2 7 P R S														
NAC-4 8 T U V	NAC-3 9 W X Y														

Command Menu-->Panel Config

Default Configuration

<pre> Load the default settings? Y </pre> <p>Press "UP" and "DOWN" to select between Y/N. if "ENTER" is pressed the default configuration is restored.</p> <pre> Default settings have been loaded </pre>	<p>Use this function to load the default configuration in the panel.</p> <p>Warning: By loading default configuration all the previously programmed configuration is lost permanently.</p>
---	---

2. Config Info (Command-Menu)



Note: Refer to *How to Use the Keypad to Program the FA-300* on page 34 for detailed instructions on making menu selections.

<pre>Configuration type: Factory default</pre> <p>Press down arrow key to see more information.</p>	<p>Configuration type will show how the panel was configured. "Factory default" means the panel has not been configured, it is as it came from the factory. "Front Panel" means it was configured at the panel. "Serial Port" means the configuration was done from a computer through the serial port. "Modem" means the configuration was completed remotely through a modem.</p>
<pre>Job Name : No job loaded</pre>	<p>If you upload a job configuration to the panel using the PC configuration utility, the job name will appear on this screen. The job name can be up to a maximum of 20 characters.</p>
<pre>Technician ID: Unknown</pre> <p>Press down arrow key for further info</p>	<p>If you upload a job configuration to the panel using the PC configuration utility, the technician's name (ID) will appear on this screen. The technician ID can be up to a maximum of 10 characters.</p>
<pre>Cfg. Date and Time: hh:mm day year:mm:dd</pre> <p>Press down arrow key for further info</p>	<p>Configuration date and time will appear for all means of configuration, thus revealing date and time configuration was last changed (if Time and Date have been set at the panel).</p>
<pre>Configurator Version x.x.x.x</pre>	<p>This specifies the configuration tool version. It will display 0.0.0.0 if no PC configurator has been used.</p>

3. Set Time (Command-Menu)



Note: Refer to *How to Use the Keypad to Program the FA-300* on page 34 for detailed instructions on making menu selections.

- 1 Daylight Save
- 2 Time Clock
- 3 Compensation

<p>Command Menu/Set time Date</p> <p>1. Daylight saving time</p> <div style="border: 1px solid black; padding: 5px; margin: 5px 0;"> <p>Daylight Saving</p> <p>[X] DISABLE</p> </div>	<p>[X] DISABLE ->Default [] ENABLE</p>	<p>Use this function to enable daylight savings time.</p>
<p>Command Menu/Time Clock</p> <p>2. Set time and date</p> <div style="border: 1px solid black; padding: 5px; margin: 5px 0;"> <p>HH:MM WKD YYYY-MM-DD</p> <p>00:00 MON 2000-01-01</p> </div>	<p>Default 00:00 MON 2000-01-01</p>	<p>Use this function to set the time and date. Use the "LEFT" and "RIGHT" keys to move the cursor to the desired location in the display and use the "UP" and "DOWN" keys to increase or decrease the values. Press the "ENTER" key to accept the changes and the "CANCEL" key to ignore the changes.</p> <p>Note: time is in 24hr format</p>
<p>Command Menu/Time Clock</p> <p>2. Compensation</p> <div style="border: 1px solid black; padding: 5px; margin: 5px 0;"> <p>Daily Compensation:</p> <p>0</p> </div> <p>When value is entered the following message will appear</p> <div style="border: 1px solid black; padding: 5px; margin: 5px 0;"> <p>Daily Compensation:</p> <p>Panel Config Updated</p> </div>	<p>Compensation value can range from -15 to +15 seconds.</p>	<p>Use the up down arrow keys to select daily compensation value and press ENTER. For a fast clock adjust negatively. For a slow clock adjust positively. For example: for a clock which runs 5 minutes a month (based on 30 days) fast select -10 seconds.</p>

4. Set password (Command-Menu)



Note: Refer to *How to Use the Keypad to Program the FA-300* on page 34 for detailed instructions on making menu selections.

<pre>Enter new passcode []</pre>	<p>1111 -> Default</p>	<p>Use this function to change the pass-code. The minimum number of digits is 4 and the maximum is 10. Only numeric digits are allowed.</p>
<pre>Re-enter passcode []</pre>		
<p>If the passcode does not match, the following message appears and the system exit to the main menu</p>		
<pre>invalid passcode</pre>		
<p>If the passcode is OK the following message appears and exits to the main menu</p>		
<pre>Passcode updated</pre>		

5. View Event Log (Command-Menu)

The event log looks the same as the normal event queue. Pressing the “INFO” key has the same effect that it does in the event queue. The illustration below provides an example of how the “INFO” key works and shows the CFG-300 LCD Configuration tool display.

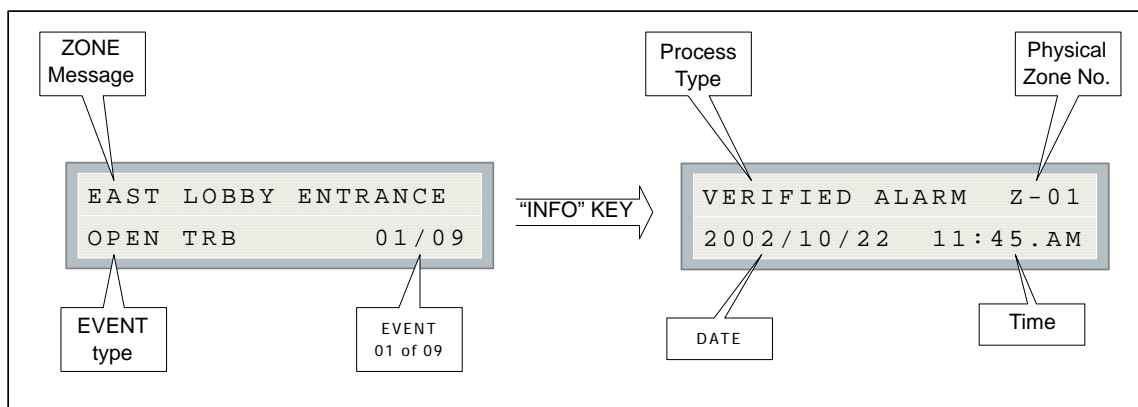

There are a maximum of 200 recent events saved in the event log. If the number of events goes beyond 200, the oldest event is overwritten by the most recent one.

6. Clear Event Log (Command-Menu)



Note: Refer to *How to Use the Keypad to Program the FA-300* on page 34 for detailed instructions on making menu selections.

```
-Select Log-
```

```
1 Alarm Log
```

```
2 General Log
```

```
3 All Logs
```

Select the type of log to clear. Press the "ENTER" key. The system will then confirm before clearing logs.

```
Clear all the  
selected log(s)? Y
```

Press the "ENTER" key to confirm or the "CANCEL" key to cancel the operation.

```
Log(s) cleared
```

Use this function to clear alarm logs, event logs, or both.

7. Walk Test (Command-Menu)



Note: Refer to *How to Use the Keypad to Program the FA-300* on page 34 for detailed instructions on making menu selections.

Walk-Test allows an installer to verify the initiating circuit wiring in a system. When walk test is selected, the following screen confirms the operation:

```
Perform the
walk test? Y
```

Press the “ENTER” key to activate the walk test and the “CANCEL” key to cancel the walk test. The next screen will allow zones to be selected for walk test. Use the “UP” and “DOWN” keys to scroll through the zones and use the “LEFT” or “RIGHT” keys to select a zone. Press the “ENTER” key when you are done with all the selections.

```
-WALK TEST ZONES-
[ ] Zone-1
```

The walk test is now active (see illustration below)

```
-Walk test active-
Alarm:00      Trb:00
```

The activation of any initiating circuit that has been selected for a walk test will cause the Audible Indicating Circuits (not Strobes) to activate briefly for a number of short bursts corresponding to the selected circuit number. If the first selected circuit is activated, the indication circuits will sound for one burst. If the second selected circuit is activated, the indication circuits will sound for two bursts, and so on. This means that if, for example, circuits 1, 3 and 5 were selected for the walk test, they would sound with one, two and three bursts respectively. The burst interval is half a second on and half a second off. After the sounding pattern has been sent on the indicating circuits, the initiating circuit is reset and tested again. If it is still active (in alarm) the pattern will be re-sent. Trouble on any initiating circuit selected for the walk test activates the indicating circuits continuously for five seconds. Activation of a circuit will also cause the alarm count to increase while the trouble on the initiating circuit will cause the trouble count to increase.

Alarm Verification and Water flow Alarm Retard Operations are disabled on circuits being walk tested. All circuits not selected for the walk test continue to function normally. If a circuit was disconnected before the walk-test mode was entered and is not selected for the walk-test, it remains disconnected while the walk test is active. Walk test operation is disabled if the Fire Alarm Control Panel is in alarm or goes into alarm while the walk test is active.



Notes:

- If a UDACT is used with the system, all walk-test events will be reported to the monitoring agency. The monitoring agency should be instructed to ignore reported events during the walk-test.
- IF THERE IS NO ACTIVITY FOR ONE HOUR, THE SYSTEM WILL RETURN TO NORMAL OPERATION.

8. i³ Loop Test (Command-Menu)



Note: Refer to *How to Use the Keypad to Program the FA-300* on page 34 for detailed instructions on making menu selections.

The i³ maintenance test is designed to test the devices on i³ zone. If there is noise on the line or if the device is too far away from the panel, the devices may not respond to the panel inquiries. An i³ maintenance test can be invoked from the command menu six minutes after power-up or after pressing the reset. If the i³ maintenance test is selected, the following message appears on the screen:

```
Perform the i3
Loop test? Y
```

If you select “yes” by pressing “ENTER”, the display will ask you for which zone you want to perform the i³ test. Note that only one zone at a time can be in maintenance test. Select the zone by pressing the “UP” and “DOWN” keys and then pressing the “RIGHT” key to select the device. After the device is selected press “ENTER”.

```
- I3 TEST ZONES -
[ ] Zone-1
```

If the i³ maintenance test is selected within six minutes after power-up or reset, the following information message is displayed.

```
The selected zone
is not ready yet
```

If a zone is selected that is not configured as an i³ zone, the following message is displayed:

```
The selected zone
is not i3 type
```

After the zone goes into the i³ maintenance test, no other zone can be put into the test. The maintenance test will take five minutes. During this time you can walk through the device and make sure all the devices are working properly. The following table lists the status of the devices while in walk test.

i ³ Detector Condition	Green LED	Red LED
Proper operation	Double blink every 5 sec	OFF
Out of sensitivity (Low and High Maint)	OFF	Double blink every 5 sec
Freeze condition	OFF	Double blink every 10 sec

You can cancel the maintenance test either by pressing the “RESET” key or by going into the configuration section and canceling the test.

9. Dialer Config (Command-Menu)



Note: Refer to *How to Use the Keypad to Program the FA-300* on page 34 for detailed instructions on making menu selections.

The following illustration shows the dialer configuration menu. This menu will show up only if there is a built-in dialer on the main board. Each item in this menu is described below in detail.

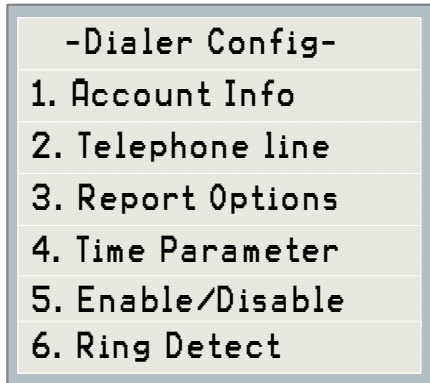

Command Menu-->Dialer Config

Account Info

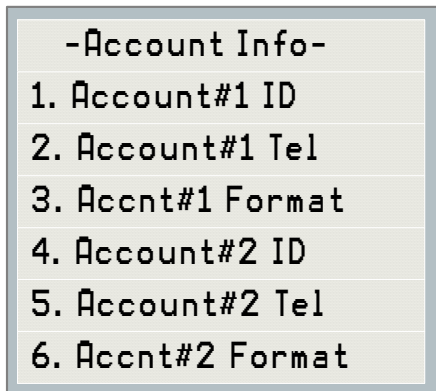

Command Menu/Dialer Config/Account Info

1.Account# 1 Identification

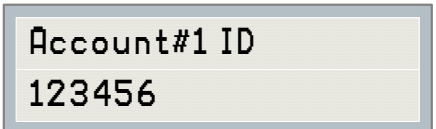

123456-->Default

Use this function to set the Account ID for the monitoring station to which the dialer reports events. The maximum # of digits allowed is six. For contact ID, only the first four digits are used; the last two are truncated.

Unless you are using the SIA protocol, the allowed digits for the account ID are simple digits 0 to 9 and hexadecimal digits A to F (the SIA protocol only allows digits 0 to 9).

To enter hexadecimal digits, press the INFO button. The letter "A" will appear. To scroll through the rest of the letters, press INFO repeatedly. Press # to move the cursor to the right or press * to move it to the left.

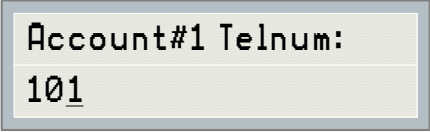
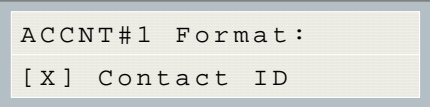
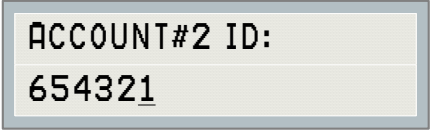
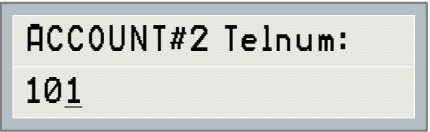
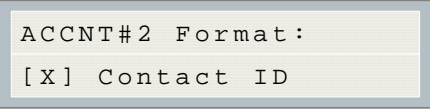
<p>Command Menu/Dialer Config/Account Info 2.Account#1 Telephone Number</p> 	<p>[101]->Default</p>	<p>Use this function to set the telephone number of the monitoring station. The maximum # of digits allowed is 19 including “,” and numerals. The “,” will be treated as 1 sec delay. To enter “,” press the INFO button. Press # to move the cursor to the right or press * to move it to the left. An example of a typical telephone # is 9,,12345678.</p>
<p>Command Menu/Dialer Config/Account Info 3.Account#1 Reporting Format</p> 	<p>[X] CONTACT ID-Default [] SIA 300 Baud [] SIA 110 Baud</p>	<p>Set the reporting format that is recognized or preferred by the monitoring station.</p>
<p>Command Menu/Dialer Config/Account Info 4. Account# 2 Identification</p> 	<p>654321->Default</p>	<p>Same as Account#1.</p>
<p>Command Menu/Dialer Config/Account Info 5.Account# 2 Telephone Number</p> 	<p>[101]->Default</p>	<p>Same as Account#1.</p>
<p>Command Menu/Dialer Config/Account Info 6.Account# 2 Reporting Format</p> 	<p>[X] Contact ID-Default [] SIA 300 Baud [] SIA 110 Baud</p>	<p>Same as Account#1.</p>

Command Menu-->Dialer Config



Note: Refer to *How to Use the Keypad to Program the FA-300* on page 34 for detailed instructions on making menu selections.

Telephone Line

```
- Telephone Line -
1 Line1 Dialtype
2 Line2 Dialtype
3 Line1 Dialtone
4 Line2 Dialtone
5 Num of Retries
```

<p>Command Menu/Dialer-Config/Telephone Line</p> <p>1. Line#1 Dialing Type</p> <pre>Line#1 Dialing Type: [X] DTMF Dial</pre>	<pre>[X] DTMF Dial->Default [] Pulse Dial</pre>	<p>Set the dialing type for line #1; this is the type recognized or preferred by the telephone company.</p>
<p>Command Menu/Dialer-Config/Telephone Line</p> <p>2. Line#2 Dialing Type</p> <pre>Line#2 Dialing Type: [X] DTMF Dial</pre>	<pre>[X] DTMF Dial->Default [] Pulse Dial</pre>	<p>Same as Line#1.</p>
<p>Command Menu/Dialer-Config/Telephone Line</p> <p>3. Line#1 wait for Dial tone</p> <pre>Line#1 Wait Dialtone [X] ENABLE</pre>	<pre>[X] ENABLE ->Default [] DISABLE</pre>	<p>Use this function to let the system know whether or not to wait for a dial tone before dialing. Cell phone setup for the dialer requires that the system not wait for dial tone before dialing.</p>
<p>Command Menu/Dialer-Config/Telephone Line</p> <p>4.Line#2 wait for Dial tone</p> <pre>Line#2 Wait Dialtone [X] ENABLE</pre>	<pre>[X] ENABLE ->Default [] DISABLE</pre>	<p>Same as Line#1.</p>
<p>Command Menu/Dialer-Config/Telephone Line</p> <p>5.Number of retries</p> <pre>Number of Retries: 06</pre>	<pre>06 ->Default</pre>	<p>Set the number of retries for both line#1 and line#2. This function lets the dialer retry on either line if it is busy or not available. If the retry count expires, the panel reports a line trouble.</p>

Command Menu-->Dialer-Config



Note: Refer to *How to Use the Keypad to Program the FA-300* on page 34 for detailed instructions on making menu selections.

Report Options

```
-Report Options-
1. Alarm Prio.
2. Trouble Prio.
3. Supv. Prio.
4. Aux. Dis Report
5. Operation Mode
```

<p>Command Menu/Dialer-Config/Report Options</p> <p>1.Alarm priority</p> <pre>Alarm Priority: [X] Account 1</pre>	<pre>[X] Account 1->Default [] Account 2</pre>	<p>Use this function to set the account priority for reporting alarms. If the priority is set for account#1 then the dialer will try account#1 first for reporting.</p>
<p>Command Menu/Dialer-Config/Report Options</p> <p>2.Trouble priority</p> <pre>Trouble Priority: [X] Account 1</pre>	<pre>[X] Account 1->Default [] Account 2</pre>	<p>Use this function to set the account priority for reporting trouble. If the priority is set for account#1 then the dialer will try account#1 first for reporting.</p>
<p>Command Menu/Dialer-Config/Report Options</p> <p>3.Supervisory priority</p> <pre>SUPV Priority [X] Account 1</pre>	<pre>[X] Account 1->Default [] Account 2</pre>	<p>Use this function to set the account priority for reporting supervisory troubles. If the priority is set for account#1 then the dialer will try account#1 first for reporting.</p>
<p>Command Menu/Dialer-Config/Report Options</p> <p>4.Aux Disconnect, Cancels Alarm & Supv Reporting Through dialer</p> <pre>AuxDis Alm/Supv Rpt. [X] DISABLE</pre>	<pre>[] ENABLE [X] DISABLE ->Default</pre>	<p>If this function is enabled, the Aux Disconnect feature (obtained by pressing the Aux Disconnect button) will block the alarm and supervisory events from being reported through the built-in dialer.</p>

<p>Command Menu/Dialer-Config/Report Options</p> <p>5.Dialer operation mode</p> <div style="border: 1px solid black; padding: 5px; width: fit-content;"> <p>Dialer Oper. Mode</p> <p>[X] (U) DACT</p> <p>[] DACT</p> </div>	<p>[X] (U) DACT ->Default</p> <p>[] DACT</p>	<p>Use this function to select the functionality of the dialer. In DACT mode only common trouble/alarm/supervisory are reported while in UDACT mode all point information is reported</p>
---	--	---

Command Menu-->Dialer-Config



Note: Refer to *How to Use the Keypad to Program the FA-300* on page 34 for detailed instructions on making menu selections.

Time Parameters

-Time Parameter-

1 AC-Loss Delay

2 Cellphone Date

3 Auto-Test Time

<p>Command Menu/Dialer-Config/Time Parameter</p> <p>1.AC Loss delay</p> <div style="border: 1px solid black; padding: 5px; width: fit-content;"> <p>AC-Loss Delay(Hrs)</p> <p>0</p> </div>	<p>0 ->Default</p>	<p>Use this function to delay the reporting of AC loss trouble on the dialer for the programmed time period.</p>
<p>Command Menu/Dialer-Config/Time Parameter</p> <p>2.Cellular report date</p> <div style="border: 1px solid black; padding: 5px; width: fit-content;"> <p>Cellular Report Date</p> <p>0</p> </div>	<p>0 ->Default</p>	<p>Use this function to set the test report date for the cell phone setup. If the date is set to 0, this means there is no test reporting for cell phone or the phone line is a regular line. Other settings could be anywhere from 01-28, representing which day of the month the test should be performed. When a cell phone service is employed for the panel, it should only be connected to telephone line #2 CO interface. Also, the dial tone detection feature of Line #2 should be disabled for cell phone application.</p>
<p>Command Menu/Dialer-Config/Time Parameter</p> <p>3. Auto test time</p> <div style="border: 1px solid black; padding: 5px; width: fit-content;"> <p>Auto-Test (HH:MM):</p> <p>00:30</p> </div>	<p>00:30 ->Default</p>	<p>Use this function to set the time for auto test. This test has to be performed once a day to send the test report to the monitoring station. The time is in 24hr format, which means 00:30 is 30 minutes after midnight.</p> <p>Please do not use the following test times: 00:00, 01:55, 02:00 and 03:00.</p>

Command Menu-->Dialer-Config



Note: Refer to *How to Use the Keypad to Program the FA-300* on page 34 for detailed instructions on making menu selections.

Dialer Enable/Disable

<pre>Dialer Ena/Dis [X] ENABLE</pre>	<pre>[X] ENABLE ->Default [] DISABLE</pre>	<p>The dialer is enabled by default. When the dialer is enabled or disabled, a warning message appears.</p> <p>Warning: The dialer cannot report any event to the monitoring station if it is disabled.</p>
<pre>-----Warning----- Dialer Disabled!!!</pre>		

Command Menu-->Dialer-Config

Ring Detect

<pre>-Ring Detect Number- [X] 5</pre>	<pre>[] Disabled [] 1 [] 2 [] 3 [] 4 [X] 5->Default [] 6 [] 7 [] 8</pre>	<p>Use this menu item to select the number of rings on which the panel's modem will answer. The default number of rings is five. The maximum number of rings you can define is eight.</p> <p>If you select the "Disabled" option, the modem will be disabled and the panel will not pick up the incoming call.</p>
---------------------------------------	---	--

10. Test Dialer (Command-Menu)

<pre>-Dialer Test- 1. L#1 Manual test 2. L#2 Manual test 3. Reset Dialer</pre>
--

<pre>1.L#1 Manual test</pre>	<p>Press Enter to test Line #1. Press Cancel to exit this menu. For a description of test messages, see <i>Dialer Test Messages</i> on the following page.</p>
<pre>2.L#2 Manual test</pre>	<p>Press Enter to test Line #2. Press Cancel to exit this menu. For a description of test messages, see <i>Dialer Test Messages</i> on the following page.</p>
<pre>3.Reset Dialer</pre>	<p>This feature flushes all reportable events from the buffer. Press Enter to reset the dialer. Press Cancel to exit this menu.</p>

Dialer Test Messages

The following messages will display during the test processes of Lines #1 and #2. The messages that will appear depend on the status of the dialer and the test results that are found.

Dialer idle now	The dialer is checking the line for voltage. This message automatically displays when Manual Test is selected.
No DC Volt	No DC line voltage. The line is dead or no phone line is connected.
Waiting for Dialtone	The dialer is waiting for a dial tone.
Failed: No Dialtone	This message may indicate a noisy telephone line.
Dialing Receiver Now	The dial tone was received and telephone number dialing is in process.
No DTMF tone	This message indicates that the dialer failed to send a DTMF tone.
Waiting for Acktone	Waiting for availability of the receiver. The receiver confirms the availability by sending an ack tone.
Failed No Acktone	This message indicates that either the telephone number may be wrong or the receiver is not available.
Reporting Event Now	When sending events to the receiver, the display will toggle between this message and "Waiting for Kissoff " for all events sent.
Waiting for Kissoff	The dialer is waiting for the kissoff tone. The kissoff tone indicates that the receiver has received the event reports.
No Kissoff	No Kissoff means receiver has not received any event reports.
Passed: Manual test	The line passed the test; everything is OK.

11. Exit (Command-Menu)

Pressing, “ENTER” after selecting “Exit” from the menu will return the panel to normal LCD operation.

CFG-300 LCD Service tool operation

If an LCD service tool is connected to the panel, you will only be able to view the latest message—you cannot scroll through them. In order to see all of the messages, you must enter the programming menu and see the event logs. The logs are arranged so that the most recent message is shown first. Listed below are the different kinds of messages that can be displayed on the LCD service tool.

Zone messages

Point annunciation is indicated on the LCD. There are no separate queues for “TROUBLE”, “ALARM”, “SUPERVISORY” and “MONITOR”; instead there is only one queue that indicates all the events. The respective TROUBLE, ALARM, SUPVISORY and MONITOR LEDs will be flashing if at least one of the given types is in the queue.

The LCD service tool will only show the first alarm or trouble. If a trouble happens first and then an alarm, the alarm will be displayed. Any further events will change the total number of events, shown in the right hand corner of the LCD display. The order of priority is alarm, supervisory, trouble and monitor.

Example 1 (detection circuit):

Event “01/09” 01 of 09, “OPEN TRB” on physical “Z-01” at “EAST LOBBY ENTRANCE”. Press the INFO key to show the process type as “VERIFIED ALARM” and the event occurred on “2003/04/04” at “18:01 TUESDAY”.

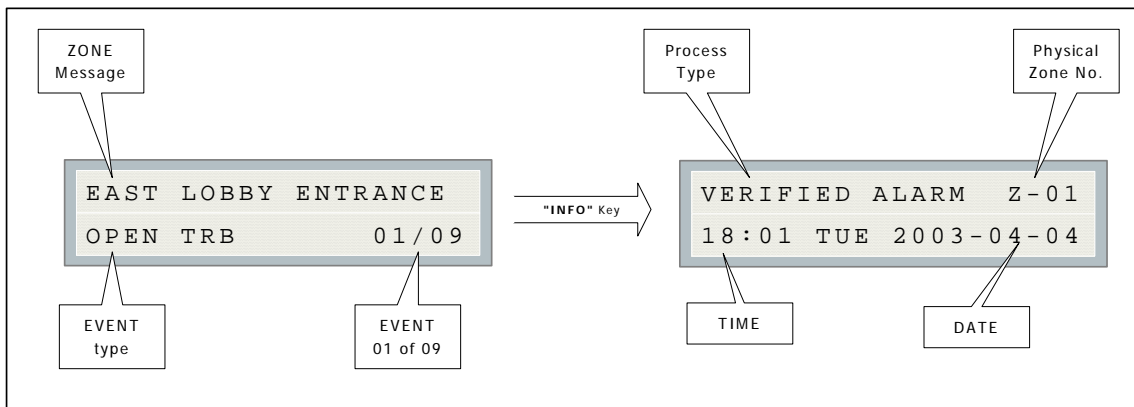

Example 2 (indicating circuit):

Event “02/09” 02 of 09, “SHORT TRB” on physical “NAC-01” at “EAST WING LOBBY” with process type as “SILENCEABLE” and the event occurred on “2003/02/02” at “18:01 TUESDAY”.

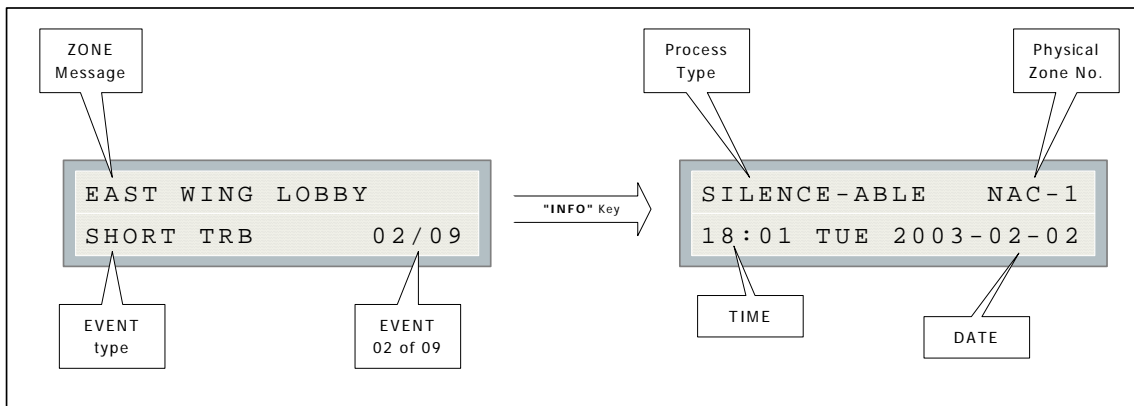

Other common messages are listed on the following pages.

AC Power Fail

The AC power fail trouble is generated when the power drops below the UL specified value. The trouble is restored when the power returns to the normal value.

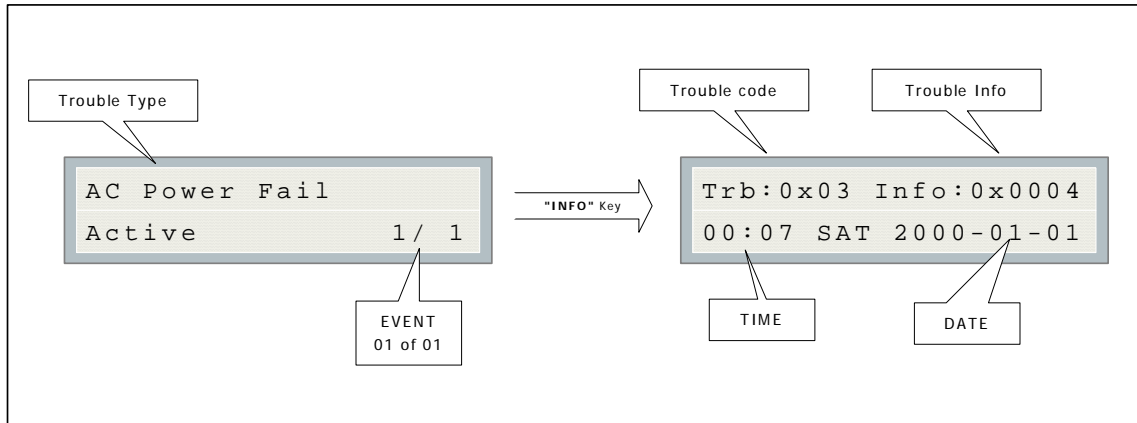

Battery trouble

The battery trouble is generated when the battery voltage drops below the specified value. The trouble is restored when the voltage returns to the normal value.

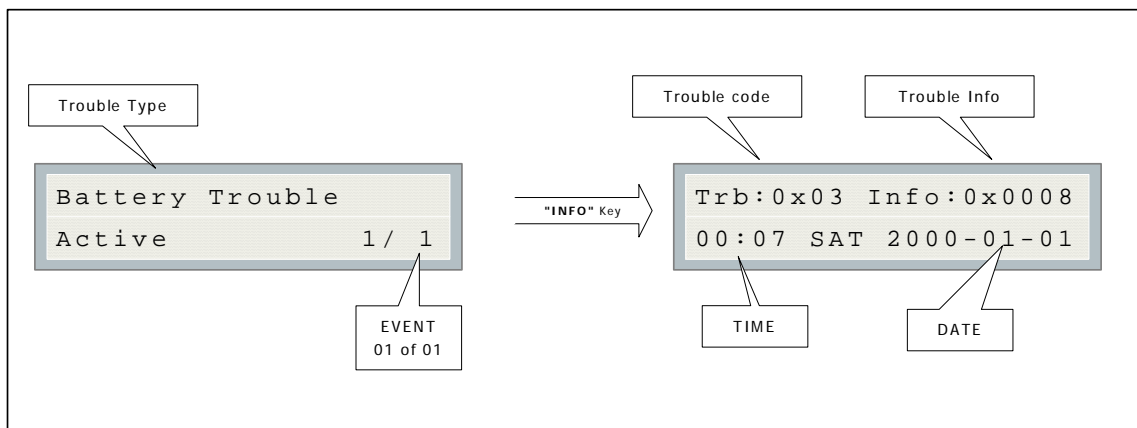

Ground Fault

The "Ground Fault" message indicates that there is a short in the electrical connection between the metal chassis of the panel and the earth.

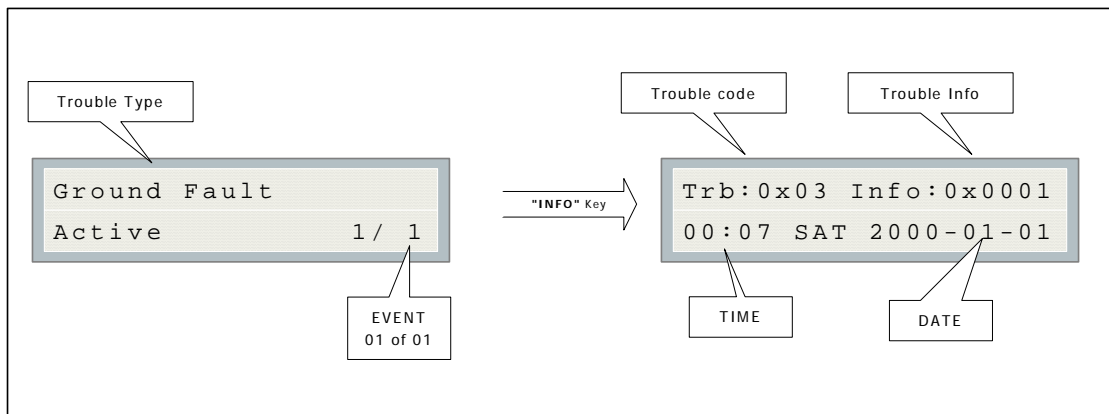

Note: The trouble code and info is for trained service personnel only.

Remote Annunciator

Troubles related to the annunciator can have two possibilities: either the main panel and annunciator failed to communicate with each other, or an un-configured remote annunciator is responding to the main panel. In both the cases, the following trouble message is displayed:

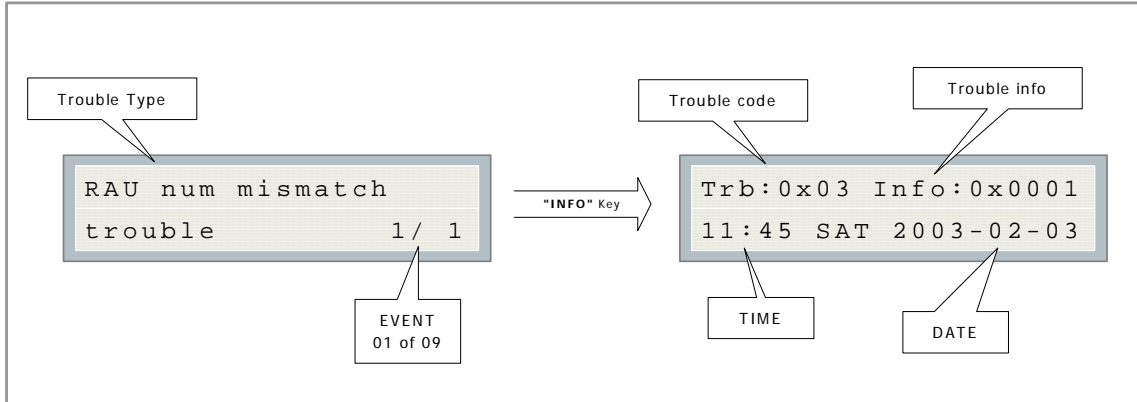

Four-wire smoke detector supply

The four-wire smoke detector supply is supervised for shorts. When a short is detected on a four-wire smoke supply the power is cut off and a trouble message is generated. Press the system "RESET" key to restore the power the system. If the short is removed, the panel will return to normal; otherwise the trouble message will stay.

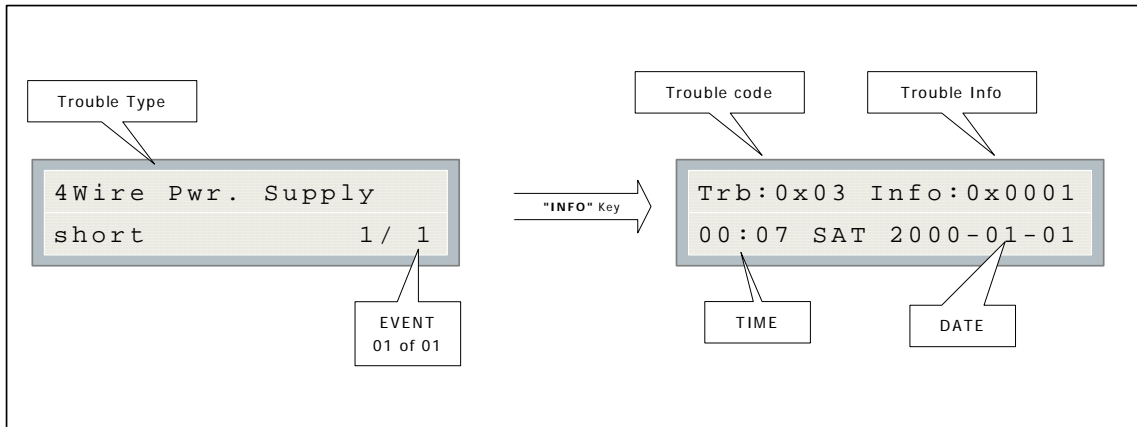

Note: The trouble code and info is for trained service personnel only.

Supervised Aux-supply

The supervised aux-supply is supervised for shorts. When a short is detected on supervised aux-supply the power is cut off and a trouble message is generated. Press the system "RESET" key to restore the power the system. If the short is removed, the panel will return to normal; otherwise the trouble message will stay.

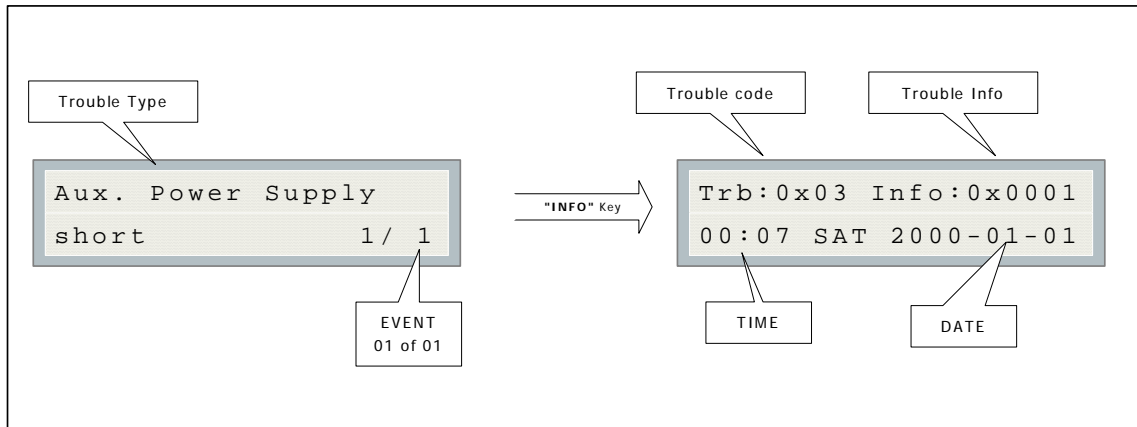

City tie Polarity reversal - PR-300/ Relay module

The city tie or polarity reversal module is supervised for open and whether or not the PR-300 is plugged in. The relay module is supervised for whether or not it is plugged in.

If any of the modules are not plugged in, the following trouble message is generated:

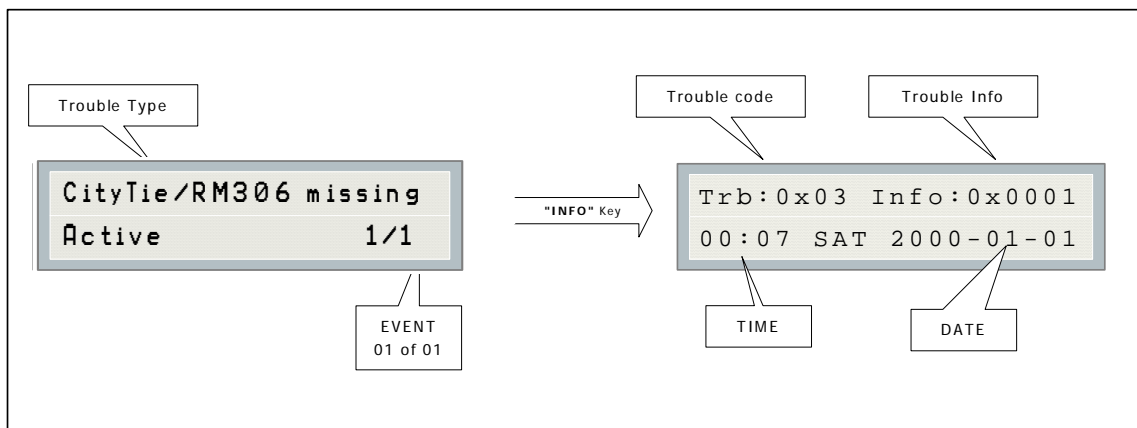

If there is an open detected on the city tie output, the following trouble message is displayed:

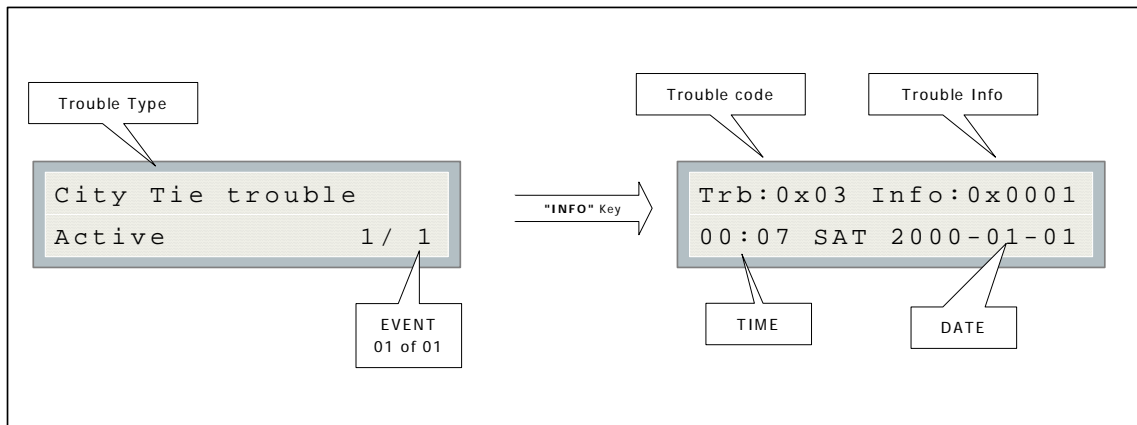

Appendix A: Compatible Receivers

The dialers that are built into select models of the FA-300 Series Fire Alarm Control Panels are compatible with the following Digital Alarm Communicator Receivers (DACR):

DACR Receiver Model

SurGard MLR2 Multi-Line Receiver (ULC, ULI approved)
SurGard SLR Single-Line Receiver (ULC, ULI approved)
Osborne-Hoffman Quickalert! II Receiver (ULI approved)
Osborne-Hoffman OH-2000 Receiver (ULI Approved)
Silent Knight Model 9500 Receiver (ULI Approved)
Radionics Model D6500 Receiver (ULI Approved)
Radionics Model D6600 Receiver (ULI Approved)

Protocols

SIA-DCS and Ademco Contact ID
SIA-DCS and Ademco Contact ID
SIA-DCS and Ademco Contact ID
SIA-DCS and Ademco Contact ID
SIA-DCS and Ademco Contact ID
SIA-DCS and Ademco Contact ID
SIA-DCS and Ademco Contact ID

Appendix B: Reporting

Ademco Contact-ID

FA-300 Event Codes

Event Description	Event Family	Qualifier	Code	Group #	Contact #
Phone Line #1 trouble detected	Trouble	New event	1 351	00	000
Phone Line #2 trouble detected	Trouble	New event	1 352	00	000
Phone Line #1 trouble restored	Trouble	Restore	3 351	00	000
Phone Line #2 trouble restored	Trouble	Restore	3 352	00	000
Failure to report to an Account	Trouble	New event	1 354	Acct #	Acct #
Report to an Account successful	Trouble	Restore	3 354	Acct #	Acct #
RS-485 Communication Trouble	Trouble	New event	1 350	00	485
Periodic (24 hr) Test Event (NORMAL)	Test	New event	1 602	00	000
Periodic (24 hr) Test Event (OFF NORMAL)	Test	New event	1 608	00	000
Manually initiated dialer test	Test	New event	1 601	00	000
Zone Fire Alarm	Alarm	New event	1 110	00	NNN
Zone Fire Alarm restored	Alarm	Restore	3 110	00	NNN
Zone Trouble detected	Trouble	New event	1 300	00	NNN
Zone Trouble restored	Trouble	Restore	3 300	00	NNN
Zone Supervisory condition	Supervisory	New event	1 200	00	NNN
Zone Supervisory restored	Supervisory	Restore	3 200	00	NNN
Waterflow	Alarm	New event	1 113	00	NNN
Waterflow restored	Alarm	Restore	3 113	00	NNN
Indicating Zone Trouble	Trouble	New event	1 320	00	NNN
Indicating Zone Trouble restored	Trouble	Restore	3 320	00	NNN
General Alarm	Alarm	New event	1 140	00	NNN
General Alarm restored	Alarm	Restore	3 140	00	NNN
AC power lost	Trouble	New event	1 301	00	000
AC power restored	Trouble	Restore	3 301	00	000
Battery Low	Trouble	New event	1 302	00	000
Battery Low restored	Trouble	Restore	3 302	00	000
Ground Fault	Trouble	New event	1 310	00	000
Ground Fault restored	Trouble	Restore	3 310	00	000

Security Industries Association SIA-DCS

SIA protocol does not define indicating zone troubles, but lists it as Untyped Zone Trouble/Restore.

FA-300 Event Codes

Event Description	Event Family	Qualifier	SIA Event Code	Parameter
Phone Line #1 trouble detected	Trouble	New event	LT	001
Phone Line #2 trouble detected	Trouble	New event	LT	002
Phone Line #1 trouble restored	Trouble	Restore	LR	001
Phone Line #2 trouble restored	Trouble	Restore	LR	002
Failure to report to an Account	Trouble	New event	RT	Acct #
Report to an Account successful	Trouble	Restore	YK	Acct #
RS485 Communication Trouble	Trouble	New event	YS	485
Periodic (24 hr) Test Event (Normal)	Test	New event	RP	000
Periodic (24 hr) Test Event (Off-normal)	Test	New event	RY	000
Manually initiated dialer test	Test	New event	RX	000
Zone Fire Alarm	Alarm	New event	FA	NNN
Zone Fire Alarm restored	Alarm	Restore	FH	NNN
Zone Trouble detected	Trouble	New event	FT	NNN
Zone Trouble restored	Trouble	Restore	FJ	NNN
Zone Supervisory condition	Supervisory	New event	FS	NNN
Zone Supervisory restored	Supervisory	Restore	FR	NNN
Waterflow alarm	Alarm	New event	WA	NNN
Waterflow alarm restored	Alarm	Restore	WH	NNN
General Alarm	Alarm	New event	QA	NNN
General Alarm restored	Alarm	Restore	QH	NNN
Indicating Zone Trouble (*)	Trouble	New event	UT	NNN
Indicating Zone Trouble restored (*)	Trouble	Restore	UR	NNN
AC power lost	Trouble	New event	AT	000
AC power restored	Trouble	Restore	AR	000
Battery Low	Trouble	New event	YT	000
Battery Low restored	Trouble	Restore	YR	000
Ground Fault	Trouble	New event	YP	000
Ground Fault restored	Trouble	Restore	YQ	000

Appendix C: Specifications

FA-300-6L series fire alarm control panel

Digital Signal Processor (DSP) based design. Fully configurable using CFG-300 with Password Access.

Electrical Ratings

AC line voltage

120VAC, 60Hz, 1.7A / 240VAC, 50Hz, 0.85A, 10A slow blow fuse on secondary of transformer

Power Supply Rating

6.35 amps maximum at secondary of transformer

Battery

Type: 24VDC Gel-Cell/Sealed lead acid - 10AH to 24AH

Charging capability: 10AH to 24AH

Protection: 10A on board (F1) slow blow micro fuse

Indicating circuits

4 supervised style Y (Class B) indicating circuits, configured as strobes or audibles. Terminals are labeled "SIG 1,2,3,4"

Power limited / Regulated 24VDC FWR / 1.7A @ 49C per circuit

Max power allowed = 5A

- 1.7A (aux power unfiltered if used)
- 0.5A (aux power filtered if used)
- 0.3A (4-wire smoke power if used)

if no auxiliaries are used the max power is 5A for the indicating circuits

Current consumption Standby 123mA/Alarm 316mA

Aux supply (non resettable)

power limited / 21.1Vdc regulated / 500mA max

4-wire smoke supply (resettable)

Power limited/21.1VDC regulated / 300mA max

Unfiltered supply (full wave rectified)

Power limited / Regulated 24VDC FWR / 1.7A max at 49C

Auxiliary Relays (Common alarm/supv/trb/ and auxiliary second alarm)

Must be connected to a listed power-limited source of supply FormC / 28VDC / 1A resistive load max.

Only suitable for DC applications such as visual indicators.

Initiating circuit

6 supervised style B (Class B) initiating circuits, configurable (normal or verified). Terminals are labeled "DET". Compatibility ID "A"

Power limited / 19VDC reg. / 3mA for detectors / 200mV AC ripple / 45mA max (alarm short)

1 RS-485 Connection

For remote annunciators. Terminals are labeled "RS-485".

PR-300 Polarity reversal city tie module (optional)

RM-306 Relay Module (optional)

RM-306 adder module

Must be connected to a listed power-limited source of supply
Contact rating NO / NC / 28VDC per contact / 1A resistive load max.

Only suitable for DC applications such as visual indicators.

Current consumption standby 0mA, alarm 80mA

RM-306 Input Class A Converter module

Standby 0mA / alarm 0mA

RM-306 Output Class A Converter module

Standby 0mA / alarm 0mA

SRM-312 Smart Relay Module

Must be connected to a listed power-limited source of supply

Contact rating NO/NC / 28VDC per contact / 1A resistive load max

Current consumption standby 30mA / alarm 140mA

RAM-208/216 8/16 Zone Remote Annunciator

Standby 35mA / alarm 90mA

Remote Trouble Indicator

Standby 35mA / alarm 35mA

Polarity reversal and city tie module

City tie power limited / 24VDC unfiltered / 250mA max / 14Ohms trip coil

Polarity reversal power limited / 24VDC open / 12VDC at 3.5mA / 8.5mA max (shorted)

Polarity reversal supv terminal

24VDC (normal) / -24VDC (supervisory) / 0V (trouble)

Polarity reversal alarm terminal

24VDC (normal) / -24VDC (alarm) / 0V (trouble)

Current consumption standby 50mA / alarm 300mA (city tie in use) / alarm 70mA (city tie not in use)

Ground Fault circuit

Less the 3K will generate a ground fault.

System Model: FA-300-6L Series LED Version Fire Alarm Control Panel

System Type: Local Auxiliary (using PR-300), Remote Protected Premises Station (using PR-300 or FA-300-6LD). Central Station Protected Premises (using FA-300-6LD)

Type of Service: A, M, WF, SS

Type of Signalling: Non-Coded

Applicable Standards: NFPA 70 and 72, UL-864 Rev. 9, ULC S-524, ULC S-527-99, ULC-S-536

Appendix D: Power Supply and Battery Calculations (Selection Guide)

Use the form below to determine the required secondary power supply (batteries).

IMPORTANT NOTICE							
The main AC branch circuit connection for Fire Alarm Control Panel must provide a dedicated continuous power without provision of any disconnect devices. Use #12 AWG wire with 600-volt insulation and proper over-current circuit protection that complies with the local codes.							
POWER REQUIREMENTS (ALL CURRENTS ARE IN AMPERES)							
Model Number	Description	Qty		Standby	Total Standby	Alarm	Total Alarm
FA-300-6LD	Fire Alarm, 6 Det, Control Panel FIXED ELR/ ACTIVE ELR		X	0.123/ 0.092	=	0.316/ 0.292	=
FA-300-6L	Fire Alarm, 6 Det, Control Panel FIXED ELR/ ACTIVE ELR		X	0.123/ 0.100	=	0.318/ 0.300	=
ICAC-306	Det Class A Converter Adder Module		X	0.000	=	0.000	=
OCAC-30	Sig Class A Converter Adder Module--2 Circuits		X	0.000	=	0.000	=
PR-300	Polarity Reversal and City Tie Module		X	0.050	=	0.300	=
RM-306	6 Relay Adder Module		X	0.000	=	0.080	=
SRM-312	12 Relay Smart Relay Module		X	0.030	=	0.090	=
RAM-300LCD	Smart Remote Annunciator		X	0.016	=	0.040	=
RAM-208/216	Remote Annunciators		X	0.035	=	0.090	=
RTI-1	Remote Trouble Indicator		X	0.035	=	0.035	=
Two-Wire Smoke Detectors			X	* 0.00011	=	* 0.135	=
Four-Wire Smoke Detectors			X		=		=
Signal Load (bells, horns, strobes, and etc.)			X				=
Auxiliary Power Supply for Annunciators, etc.					=		=
Total currents (Add above currents)				STANDBY	(A)	ALARM	(B)

* Assume three Initiating Circuits are in alarm.

† Use 0.084 for five minutes, 0.168 for 10 minutes and 0.5 for half hour of alarm as a multiplier figure.

* Using the a 2-wire photoelectric smoke detector.

Total Current Requirement: ALARM (B) _____ Amps. (Value obtained from column B)

Battery Capacity Requirement:

$$\text{Battery (AH)} = ([\text{STANDBY (A)} \text{ _____}] \times [(24, 60 \text{ or } 90 \text{ Hours}) \text{ _____}]) + ([\text{ALARM (B)} \text{ _____}] \times [\text{Alarm in Hr.}] \text{ _____}) = \text{(C)} \text{ _____ AH}$$

Total Alarm Current: Must be 6 amperes or less. Indicating Circuits must not to exceed 5 amperes.

Battery Selection: Multiply (C) by 1.20 to derate battery.

Warranty & Warning Information

Warning Please Read Carefully

Note to End Users: This equipment is subject to terms and conditions of sale as follows:

Note to Installers

This warning contains vital information. As the only individual in contact with system users, it is your responsibility to bring each item in this warning to the attention of the users of this system. Failure to properly inform system end-users of the circumstances in which the system might fail may result in over-reliance upon the system. As a result, it is imperative that you properly inform each customer for whom you install the system of the possible forms of failure.

System Failures

This system has been carefully designed to be as effective as possible. There are circumstances, such as fire or other types of emergencies where it may not provide protection. Alarm systems of any type may be compromised deliberately or may fail to operate as expected for a variety of reasons. Some reasons for system failure include:

•*Inadequate Installation*

A Fire Alarm system must be installed in accordance with all the applicable codes and standards in order to provide adequate protection. An inspection and approval of the initial installation, or, after any changes to the system, must be conducted by the Local Authority Having Jurisdiction. Such inspections ensure installation has been carried out properly.

•*Power Failure*

Control units, smoke detectors and many other connected devices require an adequate power supply for proper operation. If the system or any device connected to the system operates from batteries, it is possible for the batteries to fail. Even if the batteries have not failed, they must be fully charged, in good condition and installed correctly. If a device operates only by AC power, any interruption, however brief, will render that device inoperative while it does not have power. Power interruptions of any length are often accompanied by voltage fluctuations which may damage electronic equipment such as a fire alarm system. After a power interruption has occurred, immediately conduct a complete system test to ensure that the system operates as intended.

•*Failure of Replaceable Batteries*

Systems with wireless transmitters have been designed to provide several years of battery life under normal conditions. The expected battery life is a function of the device environment, usage and type. Ambient conditions such as high humidity, high or low temperatures, or large temperature fluctuations may reduce the expected battery life. While each transmitting device has a low battery monitor which identifies when the batteries need to be replaced, this monitor may fail to operate as expected. Regular testing and maintenance will keep the system in good operating condition.

•*Compromise of Radio Frequency (Wireless) Devices*

Signals may not reach the receiver under all circumstances which could include metal objects placed on or near the radio path or deliberate jamming or other inadvertent radio signal interference.

•*System Users*

A user may not be able to operate a panic or emergency switch possibly due to permanent or temporary physical disability, inability to reach the device in time, or unfamiliarity with the correct operation. It is important that all system users be trained in the correct operation of the alarm system and that they know how to respond when the system indicates an alarm.

•*Automatic Alarm Initiating Devices*

Smoke detectors, heat detectors and other alarm initiating devices that are a part of this system may not properly detect a fire condition or signal the control panel to alert occupants of a fire condition for a number of reasons, such as: the smoke detectors or heat detector may have been improperly installed or positioned; smoke or heat may not

be able to reach the alarm initiating device, such as when the fire is in a chimney, walls or roofs, or on the other side of closed doors; and, smoke and heat detectors may not detect smoke or heat from fires on another level of the residence or building.

•*Software*

Most Mircom products contain software. With respect to those products, Mircom does not warranty that the operation of the software will be uninterrupted or error-free or that the software will meet any other standard of performance, or that the functions or performance of the software will meet the user's requirements. Mircom shall not be liable for any delays, breakdowns, interruptions, loss, destruction, alteration or other problems in the use of a product arising out of, or caused by, the software.

Every fire is different in the amount and rate at which smoke and heat are generated. Smoke detectors cannot sense all types of fires equally well. Smoke detectors may not provide timely warning of fires caused by carelessness or safety hazards such as smoking in bed, violent explosions, escaping gas, improper storage of flammable materials, overloaded electrical circuits, children playing with matches or arson.

Even if the smoke detector or heat detector operates as intended, there may be circumstances when there is insufficient warning to allow all occupants to escape in time to avoid injury or death.

•*Alarm Notification Appliances*

Alarm Notification Appliances such as sirens, bells, horns, or strobes may not warn people or waken someone sleeping if there is an intervening wall or door. If notification appliances are located on a different level of the residence or premise, then it is less likely that the occupants will be alerted or awakened. Audible notification appliances may be interfered with by other noise sources such as stereos, radios, televisions, air conditioners or other appliances, or passing traffic. Audible notification appliances, however loud, may not be heard by a hearing-impaired person.

•*Telephone Lines*

If telephone lines are used to transmit alarms, they may be out of service or busy for certain periods of time. Also the telephone lines may be compromised by such things as criminal tampering, local construction, storms or earthquakes.

•*Insufficient Time*

There may be circumstances when the system will operate as intended, yet the occupants will not be protected from the emergency due to their inability to respond to the warnings in a timely manner. If the system is monitored, the response may not occur in time enough to protect the occupants or their belongings.

•*Component Failure*

Although every effort has been made to make this system as reliable as possible, the system may fail to function as intended due to the failure of a component.

•*Inadequate Testing*

Most problems that would prevent an alarm system from operating as intended can be discovered by regular testing and maintenance. The complete system should be tested as required by national standards and the Local Authority Having Jurisdiction and immediately after a fire, storm, earthquake, accident, or any kind of construction activity inside or outside the premises. The testing should include all sensing devices, keypads, consoles, alarm indicating devices and any other operational devices that are part of the system.

•*Security and Insurance*

Regardless of its capabilities, an alarm system is not a substitute for property or life insurance. An alarm system also is not a substitute for property owners, renters, or other occupants to act prudently to prevent or minimize the harmful effects of an emergency situation.

IMPORTANT NOTE: End-users of the system must take care to ensure that the system, batteries, telephone lines, etc. are tested and examined on a regular basis to ensure the minimization of system failure.

Limited Warranty

Mircom Technologies Ltd. warrants the original purchaser that for a period of two years from the date of manufacture, the product shall be free of defects in materials and workmanship under normal use. During the warranty period, Mircom Technologies Ltd. shall, at its option, repair or replace any defective product upon return of the product to its factory, at no charge for labor and materials. Any replacement and/or repaired parts are warranted for the remainder of the original warranty or ninety (90) days, whichever is longer. The original owner must promptly notify Mircom Technologies Ltd. in writing that there is defect in material or workmanship, such written notice to be received in all events prior to expiration of the warranty period.

International Warranty

The warranty for international customers is the same as for any customer within Canada and the United States, with the exception that Mircom Technologies Ltd. shall not be responsible for any customs fees, taxes, or VAT that may be due.

Conditions to Void Warranty

This warranty applies only to defects in parts and workmanship relating to normal use. It does not cover:

- damage incurred in shipping or handling;
- damage caused by disaster such as fire, flood, wind, earthquake or lightning;
- damage due to causes beyond the control of Mircom Technologies Ltd. such as excessive voltage, mechanical shock or
- water damage;
- damage caused by unauthorized attachment, alterations, modifications or foreign objects;
- damage caused by peripherals (unless such peripherals were supplied by Mircom Technologies Ltd.);
- defects caused by failure to provide a suitable installation environment for the products;
- damage caused by use of the products for purposes other than those for which it was designed;
- damage from improper maintenance;
- damage arising out of any other abuse, mishandling or improper application of the products.

Warranty Procedure

To obtain service under this warranty, please return the item(s) in question to the point of purchase. All authorized distributors and dealers have a warranty program. Anyone returning goods to Mircom Technologies Ltd. must first obtain an authorization number. Mircom Technologies Ltd. will not accept any shipment whatsoever for which prior authorization has not been obtained. NOTE: Unless specific pre-authorization in writing is obtained from Mircom management, no credits will be issued for custom fabricated products or parts or for complete fire alarm system. Mircom will at its sole option, repair or replace parts under warranty. Advance replacements for such items must be purchased.

Note: Mircom Technologies Ltd.'s liability for failure to repair the product under this warranty after a reasonable number of attempts will be limited to a replacement of the product, as the exclusive remedy for breach of warranty.

Disclaimer of Warranties

This warranty contains the entire warranty and shall be in lieu of any and all other warranties, whether expressed or implied (including all implied warranties of merchantability or fitness for a particular purpose) And of all other obligations or liabilities on the part of Mircom Technologies Ltd. neither assumes nor authorizes any other person purporting to act on its behalf to modify or to change this warranty, nor to assume for it any other warranty or liability concerning this product.

This disclaimer of warranties and limited warranty are governed by the laws of the province of Ontario, Canada.

Out of Warranty Repairs

Mircom Technologies Ltd. will at its option repair or replace out-of-warranty products which are returned to its factory according to the following conditions. Anyone returning goods to Mircom Technologies Ltd. must first obtain an authorization number. Mircom Technologies Ltd. will not accept any shipment whatsoever for which prior authorization has not been obtained.

Products which Mircom Technologies Ltd. determines to be repairable will be repaired and returned. A set fee which Mircom Technologies Ltd. has predetermined and which may be revised from time to time, will be charged for each unit repaired.

Products which Mircom Technologies Ltd. determines not to be repairable will be replaced by the nearest equivalent product available at that time. The current market price of the replacement product will be charged for each replacement unit.

WARNING: Mircom Technologies Ltd. recommends that the entire system be completely tested on a regular basis. However, despite frequent testing, and due to, but not limited to, criminal tampering or electrical disruption, it is possible for this product to fail to perform as expected.

NOTE: Under no circumstances shall Mircom Technologies Ltd. be liable for any special, incidental, or consequential damages based upon breach of warranty, breach of contract, negligence, strict liability, or any other legal theory. Such damages include, but are not limited to, loss of profits, loss of the product or any associated equipment, cost of capital, cost of substitute or replacement equipment, facilities or services, down time, purchaser's time, the claims of third parties, including customers, and injury to property.

MIRCOM MAKES NO WARRANTY OF MERCHANTABILITY OR FITNESS FOR A PARTICULAR PURPOSE WITH RESPECT TO ITS GOODS DELIVERED, NOR IS THERE ANY OTHER WARRANTY, EXPRESSED OR IMPLIED, EXCEPT FOR THE WARRANTY CONTAINED HEREIN.

