

Specifications & Instructions

Z900

CONTROL COMMUNICATOR

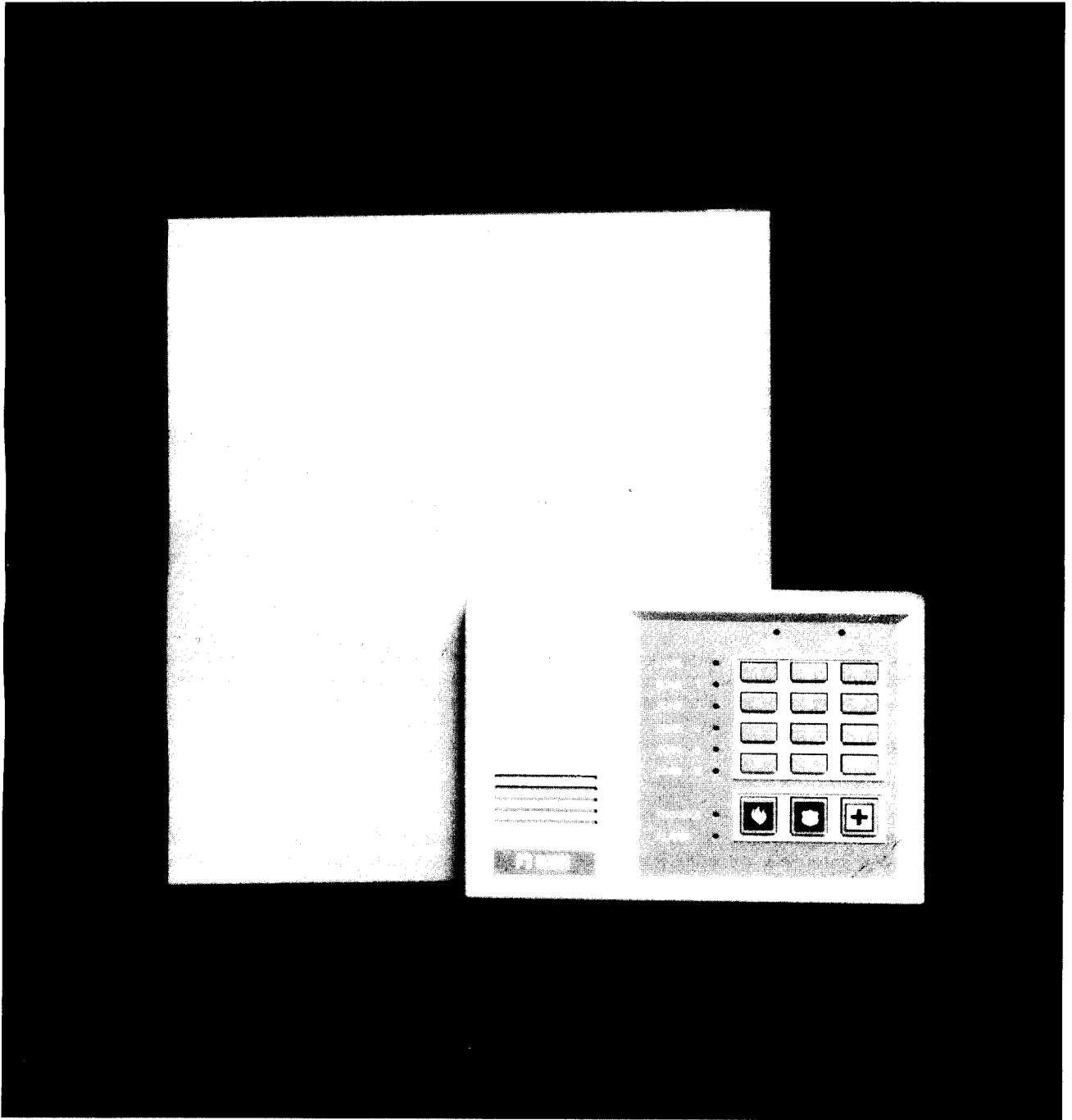

Introduction

The Z900 Security Control incorporates today's most desired operational features including upload/download, dual reporting, EEPROM memory, advanced lightning/transient protection and ease of user operation, all in an attractively priced package, complete with control station. The control is pre-programmed with two delay zones, one instant interior zone, and three instant perimeter zones. In addition, three definable emergency zones are accessible through Z900R control stations. The control may also utilize Z700R control stations in installations which require only a single emergency zone. One high current output is assignable to provide +12VDC upon any or all Burglar, Auxiliary, or Emergency alarms, or it may be assigned to one selectable non-alarm condition. In addition, an optional Z729 Siren Driver/Output Expander may be added to provide a built-in two channel, high powered siren driver and 10 assignable low current outputs which may be used to trigger other devices.

Non-volatile EEPROM (electrically erasable programmable read only memory), allows the control to be easily programmed from the Z900R control station, eliminating the need to burn PROMS. The EEPROM maintains its data even with power disconnected. A "Watchdog" circuit monitors the microprocessor and assures the operational integrity of the system. An optional MPI230 hand held Chip Duplicator allows the entire memory contents to be copied from one control to another, reducing installation time. The control may also be programmed remotely with the aid of a personal computer and a phone modem using the Aritech TRANSPORT-PC ® software package.

The Z900R control station features separate status indicators for each of the six hardwire zones, "Ready" and "Armed" LEDs, an "Alarm" LED which illuminates simultaneously with the alarmed hardwire zone for easy identification, and a "Trouble" LED which lights when installer attention is required. The control may also be armed/disarmed with a momentary or shunt type key switch.

This product has been carefully inspected to comply with rigid quality control standards before shipment to you. You'll find that with reasonable care it will provide years of reliable performance. Proper installation and regular maintenance by the installing company and frequent testing by the user are essential to assure continuous satisfactory operation of any alarm system. It is recommended that the installing company offer a maintenance program and instruct the user with the correct procedure for proper use and testing of the system.

LIMITATIONS

The Z900 is designed as part of a system designated to warn against unauthorized entry or of other emergency situations. However, it is not a guarantee of protection against the occurrence of those events. Any alarm system is subject to compromise or failure to warn for various reasons: Unauthorized access can be gained through unprotected points or by disarming or bypassing protected points. Sensing devices are power driven and will not operate without power. Telephone lines over which alarm signals are transmitted may be out of service or rendered inoperable by an intruder. Smoke detectors have limitations and cannot detect all types of fires, nor will they sense smoke or fire which is out of the effective range of the detector.

ALL RIGHTS RESERVED

No part of this publication may be reproduced, stored in a retrieval system, or transmitted in any form, or by any means - electronic, mechanical, photocopying, recording, or otherwise without the prior written permission of Aritech Corp. The material in this publication is for information purposes and subject to change without notice. Aritech Corp assumes no responsibility for any errors which may appear in this publication. Printed in U.S.A.

ff SPECIAL NOTE referencing use of the word "Fire" in this manual.

Use of this control for fire detection and/or annunciation may not be permitted by certain states, counties, municipalities, or local jurisdiction. It is the responsibility of the installing alarm company to check with their local A.H.J (Authority having jurisdiction) or State Fire Marshals' office prior to using this control for fire.

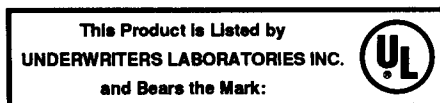

See Page 42 for listing information

Table Of Contents

Installation and Wiring	1
PLANNING THE INSTALLATION	1
PARTS DIAGRAM & DESCRIPTIONS	2
MOUNTING AND WIRING PREPARATION	3
WIRING	3
EARTH GROUND	3
STANDBY BATTERY and TRANSFORMER	6
HARDWIRE ZONE INPUTS	6
Class "B" End-of-Line Resistor Supervised Zones	6
Non-Supervised Closed Circuit Loop	7
Hardwire Zone Wiring Procedure	7
24 hr. Auxiliary Zones	8
24 Hour Communicator Report Zones	8
Keyswitch Zone	8
CONTROL STATION WIRING	8
CONTROL STATION MOUNTING	9
Troubleshooting	9
CONTROL BOARD FUSES	9
Fuse F1	9
Fuse F2	9
12 VDC OUTPUTS	10
Switched Power	10
Auxiliary 2	10
Keypad Power/Auxiliary 1	10
Assignable Output	11
Additional Outputs	11
Control Station Activated Panic Zones	11
TELEPHONE LINE CONNECTION	12

Operating the System	2
POWERING UP THE CONTROL	13
PROCEDURE	13
Watchdog Monitor	13
Automatic System Diagnosis Upon Power-Up	13
PROCESSING OF ALARMS FOLLOWING TOTAL POWER LOSS	13
THE Z900R CONTROL STATION	14
CONTROL STATION POWER-UP AND SUPERVISION	14
USER OPERATION	14
Arming/Disarming	14
Alarm Status	14
Manually Resetting Alarms	14
Control Station Activated Panic Zone Operation	15
Zone Shunting (Bypassing)	15
INSTALLER DIAGNOSTIC FEATURES	16
Identifying "Trouble" Conditions (Key 2)	16
Alarm Memory Retrieval (Key 3)	18

Programming the Control

INSTALLER LEVEL PROGRAMMING 19

- INSTALLER PROGRAM AUTHORIZATION CODE 19
- ENTERING INSTALLER LEVEL PROGRAMMING UPON POWER-UP 19
- THREE MINUTE PROGRAMMING TIMER 19
- PROGRAM FUNCTIONS 19
- THE “#” AND “*” KEYS 20
- READING THE VALUE OF A FUNCTION 20
- ZONE PLANNING GUIDE 20
- PROGRAM FUNCTION MAP 21
- EXITING THE PROGRAM MODE 21
- INSTALLER LEVEL PROGRAMMING EXAMPLE 21
- RESTORING THE FACTORY DEFAULT PROGRAM 21

USER LEVEL PROGRAMMING 22

- MASTER USER AUTHORIZATION CODE 22
- USER LEVEL PROGRAMMING FORMAT 22
- USER LEVEL PROGRAMMING EXAMPLE 22

SPECIAL PROGRAMMABLE FEATURES 23

- REMOTE PROGRAMMING (UPLOAD/DOWNLOAD) 23
 - On-Site Manually Assisted Method 23
 - Auto-Answer and Callback Method 23
 - Answering Machines 23
- SILENCE EXIT DELAY BEEP 23
- Z729 SIREN DRIVER/OUTPUT EXPANDER 23
- FORCE ARMING 23
- SUPERVISORY/TROUBLE ZONE SUB-OPTION 24
- SHUNTABLE 24 HOUR AUXILIARY “A”, “B”, “C”, AND KEYSWITCH ZONES 24
- PRIORITY (NON-SHUNTABLE) BURGLAR ZONES 24
- HIGH SECURITY ARM/DISARM CODE 24
- GROUP SHUNTING 24
- DIGITAL COMMUNICATOR 24

PROGRAMMING FUNCTION DESCRIPTIONS 25 through 38

Specifications

- TECHNICAL SPECIFICATIONS 39
- Z900 FEATURES 40
- OPTIONAL ACCESSORIES 40
- CONTROL BOARD COMPONENT LAYOUT (FIGURE 17) 41
- CONFIGURATIONS AND CURRENT DRAIN PROVISIONS (TABLE 10) 42

U.L. and N.F.P.A. Requirements

..... 43 through 46

INDEX

Installation and Wiring

PLANNING THE INSTALLATION

The first step in any multi-zone security system installation is planning the job.

1. Read through this entire manual to familiarize yourself with all system features and procedures before actually beginning the installation. Section 5 contains information regarding U.L. and N.F.P.A. requirements.
2. Perform a physical survey of the installation site.
3. Discuss the installation requirements and applications with the customer.
4. Compare the installation requirements and applications with the factory default settings (see Function Map, pages A-C) to determine what, if any, customized programming will be needed to meet the specific installation requirements.
5. We recommend that the system be bench tested prior to installation.

Figure 1 details a typical burglar installation layout. This may be used as a guide in planning the specific installation

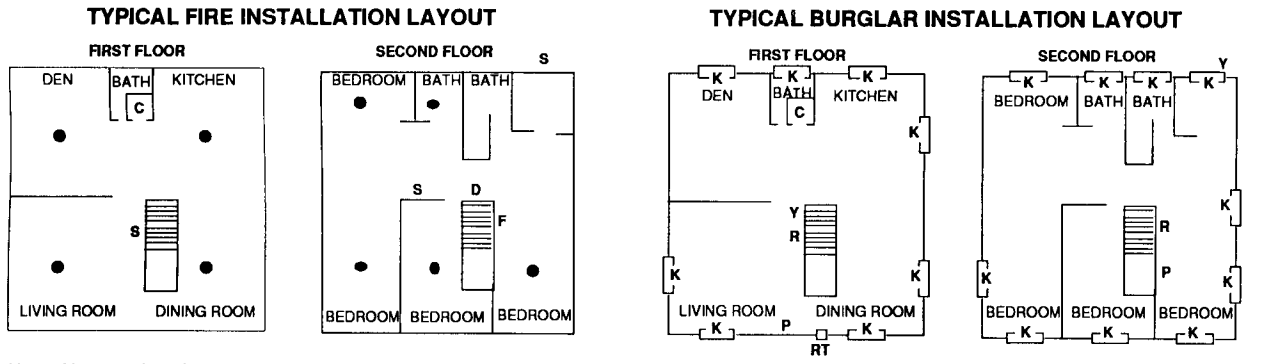

Note: Alternate locations may be required for the devices indicated.

Note: All perimeter openings below 18' should be provided with protection.

LEGEND:

- | | | |
|---------------------------|-------------------------|--------------------------------|
| C - Control | ● - Thermostat | P - Panic Button |
| S - Siren (Steady Output) | F - Fire Trouble Remote | RT - Remote On/Off with Tamper |
| Y - Siren (Yelp Output) | K - Contact | |
| D - Smoke Detector | R - Remote On/Off | |

FIGURE 1 TYPICAL INSTALLATION LAYOUT

PARTS DIAGRAM & DESCRIPTIONS

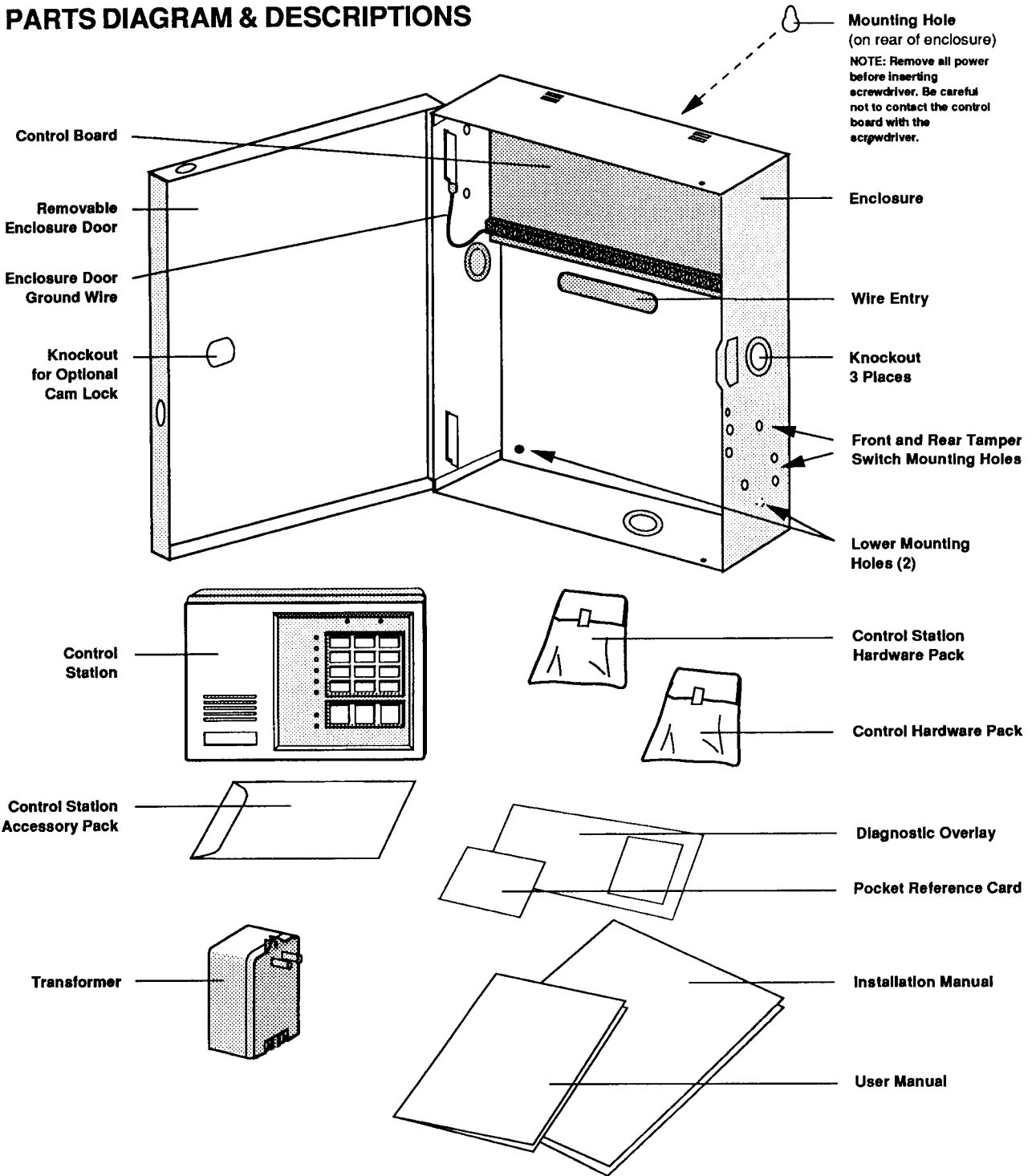

FIGURE 2 Z900 PARTS LIST

MOUNTING AND WIRING PREPARATION

1. Remove all packing material and compare the system components with those in Figure 2, page 2 to familiarize yourself with the part names as this manual will refer to them periodically.
2. Select a proper mounting location. The control must be mounted in a secure, dry location capable of maintaining an ambient temperature inside the control box of 32 to 122 degrees Fahrenheit (0 to +50 degrees Celsius).
3. Remove package components from the enclosure and set aside until pre-wiring is completed.
4. Remove control box knockouts that best suit your wiring needs. Note that each knockout is a "dual" size. The "inside" knockout is for 1/2" conduit and the "outside" is for 3/4" conduit.
5. Mount the control using the upper center slotted hole and two lower mounting holes.
6. Proceed to pull all necessary wiring for the power transformer, detection loops, control stations, siren outputs, etc.
7. Once all field wiring has been brought into the enclosure, it should be terminated as per the instructions on the following pages.

WIRING

EARTH GROUND

In order for the control's lightning and transient protection to be effective, the control must be connected to an earth ground. Finding a proper ground path may effect selection of the control mounting location as it is important to run the ground wire as short as possible.

An ideal ground for a security system is a "UNIFIED EARTH GROUND", whereby the power line, telephone, and security system ground rods are bonded together. This type of ground eliminates a common problem during lightning strikes known as "STEP VOLTAGE BLOWOUT". Step voltage is a measurable voltage potential between different earth ground stakes during a lightning strike, which results in a destructive current flow path through the security equipment.

Ground wires should be run the shortest and straightest path between the equipment and the ground rod. Avoid sharp 90 degree turns as they can cause undesired inductance in the earth ground path. This inductance blocks the lightning path to earth ground causing the lightning current to run through the security equipment. Follow the steps below to earth ground the control:

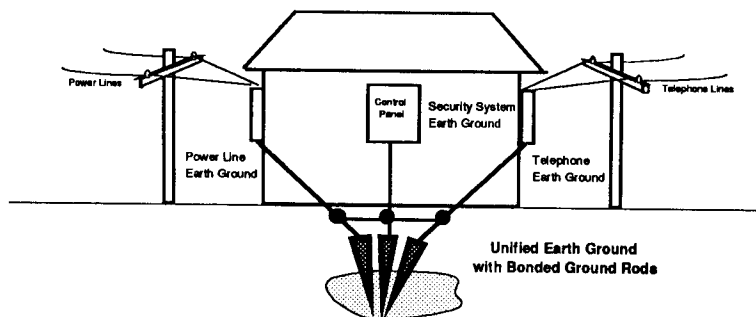
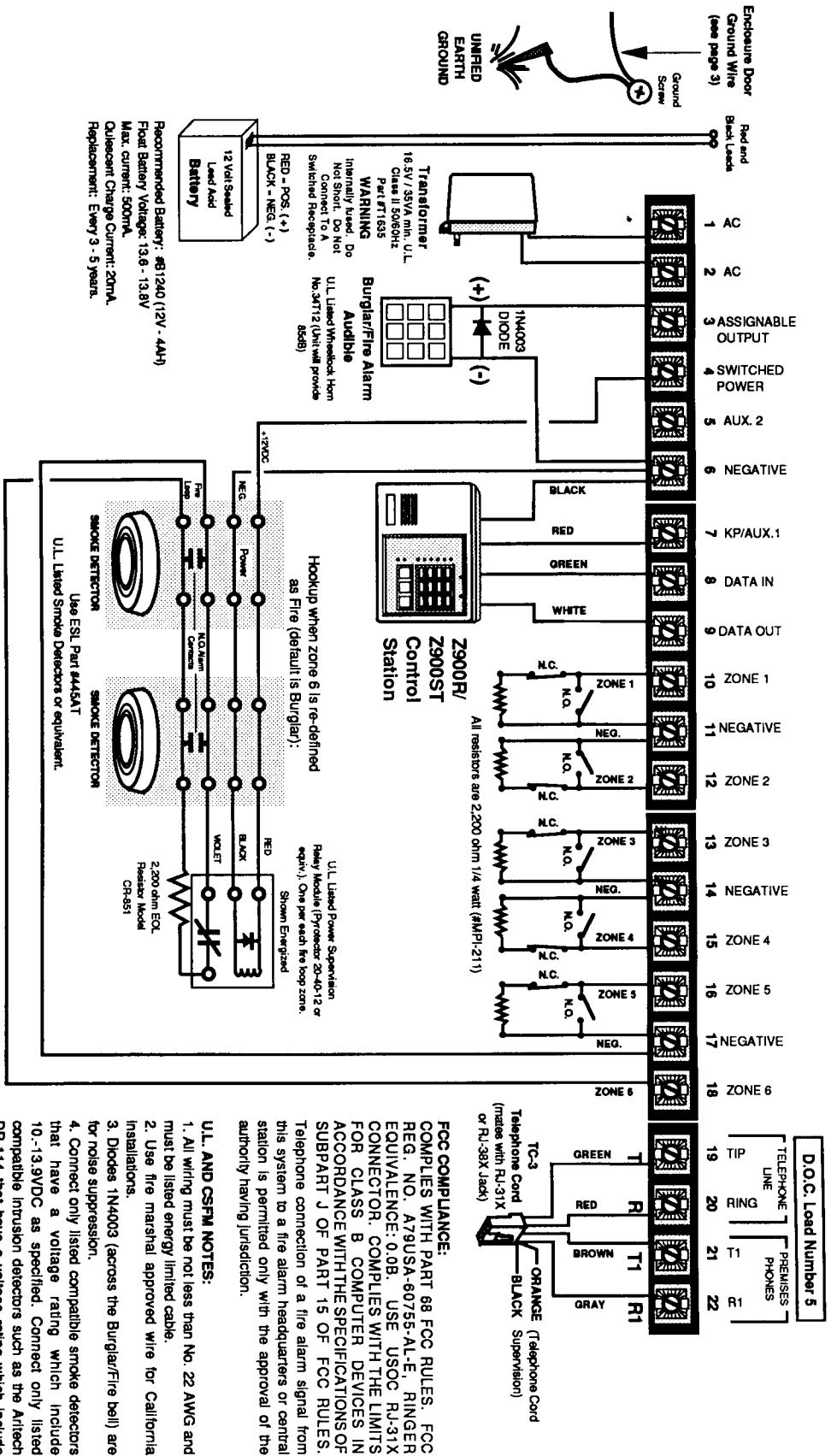

FIGURE 3 UNIFIED EARTH GROUND

1. Crimp the Ground Wire Lug to the control end of a minimum 14 gauge solid ground wire.
2. Remove the lower left control board mounting screw, insert it through the Ground Wire Lug, and replace the screw, securing the ground wire.
3. Run the earth ground wire and attach to a bonded earth ground following these guidelines:
 - A. Keep wire runs short. No 90 degree or sharp turns.
 - B. Use a minimum radius of 8 inches for bends.
 - C. Run ground wires separate from other wires.
 - D. Use 8 foot copper clad ground rods.
 - E. Route toward earth and never away.
 - F. Never run parallel to metal without properly bonding to the metal.
4. The enclosure door must be mutually grounded. Connect the female plug on the end of the green ground jumper wire (which is attached to the lower left control board mounting screw) to the bottom of the upper enclosure door hinge (see Figure 2, page 2).

NOTE: Refer to Section 5 for U.L. Listed System requirements



Lightning Protection:
 The control panel must be properly earth grounded in order for lightning/transient protection to be effective. The ground connection should be made to a dedicated metal stake as close to the control as possible.

Testing:
 This system should be tested weekly under both AC and Battery Only conditions. All switches, contacts and accessories must be U.L. Listed devices. This equipment should be installed in accordance with the National Fire Protection Association's standard No. 74 (National Fire Protection Association, Batterymarch Park, Quincy MA 02269). Control panel specifications subject to change without notice.

FIGURE 4 SUGGESTED U.L. HOUSEHOLD BURGLAR ALARM AND/OR (FIRE) ALARM HOOKUP

FCC COMPLIANCE:
 COMPLES WITH PART 68 FCC RULES. FCC REG. NO. A79USA-60/75-A1-E, RINGER EQUIVALENCE: 0.0B. USE USOC RJ-31X CONNECTOR. COMPLES WITH THE LIMITS FOR CLASS B COMPUTER DEVICES IN ACCORDANCE WITH THE SPECIFICATIONS OF SUBPART J OF PART 15 OF FCC RULES. Telephone connection of a fire alarm signal from this system to a fire alarm headquarters or central station is permitted only with the approval of the authority having jurisdiction.

- U.L. AND CSFM NOTES:**
1. All wiring must be not less than No. 22 AWG and must be listed energy limited cable.
 2. Use fire marshal approved wire for California installations.
 3. Diodes 1N4003 (across the Burglar/Fire bell) are for noise suppression.
 4. Connect only listed compatible smoke detectors that have a voltage rating which include 10.-13.9VDC as specified. Connect only listed compatible intrusion detectors such as the Aritech DR-114 that have a voltage rating which include 10.-13.9VDC.
 5. Alarm sounding devices must be installed so that they are clearly heard in all sleeping areas. Connect only listed compatible audible devices that have a voltage rating which include 10.7-13.9VDC as specified.
 6. Maximum continuous current drain for terminals 3, 4, 5, 7, and connector J15 should not exceed the limits per Table 10, page 42. The alarm condition (combined) current drain should not exceed 1500 milliamps (1.5 Amps).
 7. For U.L. Household Fire Alarm only applications, zones may be programmed to Fire defined zones.

TERM.	FUNCTION	DESCRIPTION
1	AC INPUT	Connect 16.5 VAC 35 VA U.L. Class II transformer (Part #T-1635) using 18 gauge minimum, 2 conductor wire. Do not exceed 50 feet. Do not plug in until all wiring is complete.
2	AC INPUT	
3	ASSIGNABLE OUTPUT (+)	(+)12VDC for powering devices upon alarm or other conditions as defined by Functions 256-260. See page 11. †
4	SWITCHED POWER (+)	(+)12VDC for powering smoke detectors. Control station key #7 temporarily interrupts this output to reset detectors. †
5	AUXILIARY POWER 2 (+)	(+)12VDC for powering motion detectors and other accessories. This output is fused commonly with Assignable Output (terminal 3) at 2.5 Amps (F1) and must be considered when calculating total current drain. †
6	COMMON NEGATIVE	Negative termination for devices powered by terminals 3, 4, 5, and 7. (Same as terminals 11, 14, and 17).
7	KEYPAD/AUXILIARY POWER 1 (+)	(+)12VDC for powering control stations, motion detectors, and other accessories. This output is fused commonly with Switched Power at 2.5 Amps (F2) and must be considered when calculating total current drain. †
8	CONTROL STATION DATA IN	Connect control station green leads to this terminal. Connect control station white leads to this terminal. (Use Z700 and/or Z900 control stations)
9	CONTROL STATION DATA OUT	
10	ZONE 1 LOOP (+)	Each loop requires a 2,200 Ω end-of-line resistor (Part # MPI-211). Closed or open circuit contacts may be connected to each loop. A common negative is shared between each group of two (2) zones. The need for end-of-line resistors may be eliminated on all Burglar defined zones through programming (Function 248) if desired. For UL Listed systems, the fire alarm zones require EOL resistor model CR-851. This resistor is not supplied with the control and must be ordered separately.
11	ZONE 1 AND 2 COMMON (-)	
12	ZONE 2 LOOP (+)	
13	ZONE 3 LOOP (+)	
14	ZONE 3 AND 4 COMMON (-)	
15	ZONE 4 LOOP (+)	
16	ZONE 5 LOOP (+)	
17	ZONE 5 AND 6 COMMON (-)	
18	ZONE 6 LOOP (+)	
19	INCOMING TELEPHONE LINE (T) "TIP"	Green wire from RJ-31X direct connect telephone cord. Red wire from RJ-31X direct connect telephone cord.
20	INCOMING TELEPHONE LINE (R) "RING"	
21	HOUSE PHONE CONNECTION (T1)	Brown wire from RJ-31X direct connect telephone cord. Gray wire from RJ-31X direct connect telephone cord.
22	HOUSE PHONE CONNECTION (R1)	

† Terminals 3 and 5 are fused at 2.5 Amps (fuse F1). Terminals 4 and 7 are fused at 2.5 Amps (fuse F2). Combined alarm condition current should not exceed 1.5 Amps. Maximum combined continuous current drain should not exceed the limits as indicated in Table 10, page 42.

TABLE 1 CONTROL BOARD TERMINAL DESCRIPTIONS

STANDBY BATTERY and TRANSFORMER

The control is powered by a 16.5 volt 35VA U.L. listed Class II plug-in transformer (part # T1635/supplied). Follow the wiring instructions as indicated in Table 1 and Figure 4 and 5.

A 12 Volt, 4 Amp hour minimum sealed lead acid rechargeable battery (part #B1240/not supplied) **must** be installed to provide primary power back up. The float charge voltage for the battery is set for 13.8 Volts at 400 milliamps (mA) maximum, while the system is delivering its rated continuous output current. Current in excess of 400 mA can be delivered to the battery if the system is delivering less than the rated power. The battery charging current is limited through a 5 Ohm resistor.

The battery automatically takes over and provides power in the event of an AC power outage. If the AC fails for an extended period and the battery voltage drops below 11.2 volts, the low battery detector will activate and cause the control station prealarm to beep, the "Trouble" LED to light and the digital communicator to report to the central station (if so programmed). The beep can be silenced by pressing the " * " key.

If, during a loss of AC power, the battery voltage should drop below 7.5 Volts, the microprocessor will shut down, but there will still be auxiliary equipment current drain on the battery. An MPI -266 ** Low Battery Cutoff Module may be added to disconnect the battery and protect it against deep discharge.

- Place the battery in the enclosure. Make sure that the AC transformer is disconnected.
- Connect the black battery wire to the black battery terminal marked "-".
- Connect the red battery lead to the red battery terminal marked "+" after wiring of the control is complete.

NOTE: A reverse current diode provides some protection to the electronics if the power leads are accidentally reversed.

DO NOT LEAVE THE LEADS REVERSED. OVERHEATING OF RESISTOR R85 WILL RESULT.

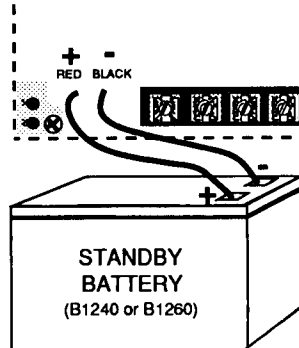

FIGURE 5

HARDWIRE ZONE INPUTS (TERMINALS 10 - 18)

The system provides six(6) individually programmable class "B" end-of-line resistor supervised detection zones. If desired, the Burglar zones may be converted from class "B" E.O.L. resistor supervised to non-supervised closed circuit only. Each hardwired zone may be configured as a Burglar, 24 hr. Auxiliary "A" (Fire ff), 24 hr. Auxiliary "B" (Police), 24 hr. Auxiliary "C" (Emergency), or communicator report only zone. In addition, a single zone may be programmed to allow system key switch operation. Each of the six zones may be further defined with various options and sub-options. The Zone Planning Guide on page D assists in planning each zone.

CLASS "B" END-OF-LINE RESISTOR SUPERVISED ZONES **

In order to function properly as a class "B" supervised circuit, a zone must have a 2,200 Ohm 1/4 watt resistor installed in series at its furthest most remote end from the control. This configuration allows both open and closed circuit contacts to be used on the same loop and provides a high degree of protection against compromise or tampering (see Figure 6). The control constantly measures the resistance on a class "B" zone and is able to determine by a proper reading of approximately 2,200 Ohms, that a zone is secure and intact. It can respond differently to a high resistance (loop open) versus a low resistance (loop short). For example, a class "B" Fire(ff) zone reacts with a supervisory/trouble condition when opened and an alarm when shorted. Supervisory/trouble is a programmable sub-option for each of the other five zone types. There is even a choice of whether a trouble condition should occur upon an open or short (non-Fire zones only). For more information see "Supervisory/Trouble Sub-Option", page 24. The system comes equipped with six 2,200 ohm 1/4 watt resistors, one for each zone. The resistors are color coded red • red • red and either a gold or silver fourth band.

** See U.L. Notes in Section 5.

❑ **NON-SUPERVISED CLOSED CIRCUIT LOOP (NO E.O.L. RESISTOR SUPERVISION) ****

If end-of-line resistor supervision of all burglar loops is not desired, conventional closed circuit loops may be connected directly to all Burglar zone input terminals by first programming Function 248 with a value of 1.

❑ **HARDWIRE ZONE WIRING PROCEDURE ****

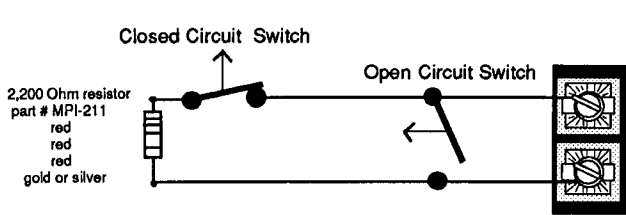

Any loop short or open will greatly change circuit resistance and violate the zone. The resistor must be placed at the end of the loop.

FIGURE 6

E.O.L. RESISTOR SUPERVISED LOOP

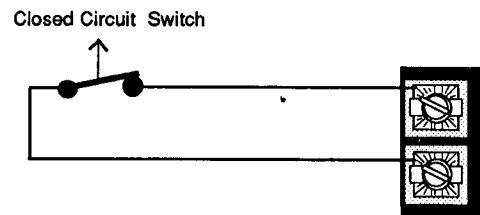

Only Burglar defined zones may be wired non-supervised and Function 248 must be programmed with a value of "1". All Burglar defined zones will then become non-supervised loops.

FIGURE 7

NON-SUPERVISED CLOSED CIRCUIT LOOP

Figure 8 is an example of how each of the detection zones might be configured in a typical installation. For ease of explanation, zones 1-6 are shown in their factory default programming configuration. They may of course be re-programmed to suit the specific needs of each installation. At this point it is only necessary to decide what each zone will be used for and make the necessary connections. Programming the actual zone definitions and responses will be explained in Section 3.

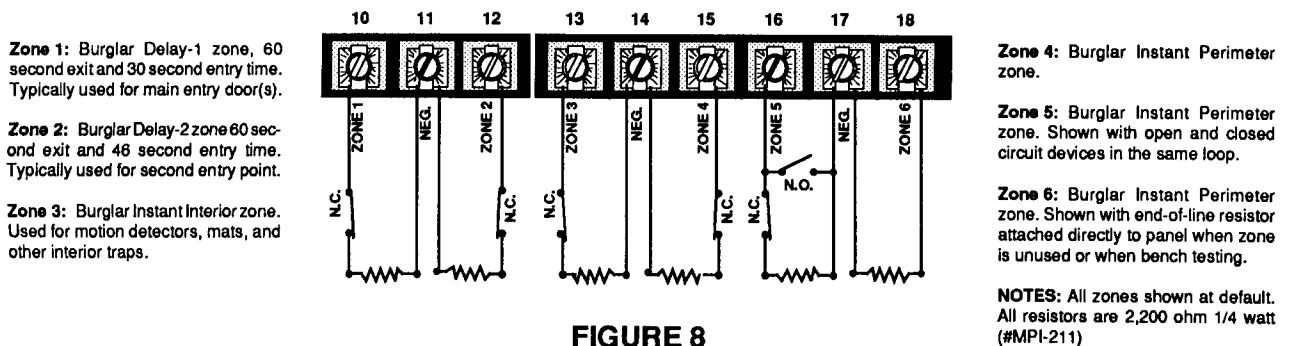

Zone 1: Burglar Delay-1 zone, 60 second exit and 30 second entry time. Typically used for main entry door(s).

Zone 2: Burglar Delay-2 zone 60 second exit and 46 second entry time. Typically used for second entry point.

Zone 3: Burglar Instant Interior zone. Used for motion detectors, mats, and other interior traps.

Zone 4: Burglar Instant Perimeter zone.

Zone 5: Burglar Instant Perimeter zone. Shown with open and closed circuit devices in the same loop.

Zone 6: Burglar Instant Perimeter zone. Shown with end-of-line resistor attached directly to panel when zone is unused or when bench testing.

NOTES: All zones shown at default. All resistors are 2,200 ohm 1/4 watt (#MPI-211)

FIGURE 8

TYPICAL ZONE WIRING EXAMPLE **

1. Decide whether Burglar defined zones are to be wired as an end-of-line resistor supervised circuit or a non-supervised closed circuit only.
2. Connect all alarm sensors to the zone wiring as per the instructions provided by the individual sensor manufacturer and Figures 4, 6 and 7.
3. Connect each zone wire to the appropriately labeled terminals as per Figure 8. Each zone has an input terminal and a common (negative) return. Please note that a negative terminal is shared by two zones and that all negatives are common to each other.
4. If end-of-line resistor supervision is not required on Burglar defined zones, Program Function 248 with a value of "1".
5. If 12 volt D.C. powered detection devices such as motion sensors are being installed, refer to section "12VDC Outputs".
6. Define each zone utilizing the "Zone Planning Guide" and program the zone definition value into the corresponding Function (see Section 3).

** See U.L. Notes in Section 5.

Z900 Specifications and Instructions

□ 24 HOUR AUXILIARY ZONES

Zones defined as 24 hour Auxiliary "A", Auxiliary "B" or Auxiliary "C" zones MUST be wired as E.O.L. resistor supervised loops. These loops are commonly used for Fire (ff), Police or Emergency inputs, however, they may also be used for other devices requiring 24 hr. supervision. A 24 hour Auxiliary "A" defined zone provides an alarm upon a loop short utilizing open circuit sensors and provides a supervisory/trouble upon an open or break in the loop. Auxiliary "B" and Auxiliary "C" defined zones can also be programmed with the supervisory/trouble sub-option.

□ 24 hr. COMMUNICATOR REPORT ZONES

Communicator report only zones MUST be wired as E.O.L. resistor supervised loops. When activated they provide no keypad indication or panel outputs and are therefore intended for simply reporting conditions from temperature sensors, water sensors, etc.

□ KEY SWITCH ZONE **

A single zone may be programmed to allow the system to be armed/disarmed with one or more momentary or maintained (shunt) contact key switch(s).

When the momentary key switch is held closed for one second, the pre-alarm will beep to indicate that the key change was acknowledged. When the key switch closure is released, the control will arm/disarm. If program Function 185 is enabled, holding the key switch closed will change the interior on/off mode once each second, then after the interior status is displayed, release the key switch to arm the system. A key switch defined zone MUST be wired as an E.O.L. resistor supervised loop. If programmed with the supervisory/trouble definition, a tamper switch may be wired to disable the key switch arm/disarm capability if the zone is violated.

If a zone is programmed for maintained key switch usage, the control stations will be disabled from either arming or disarming the control. Only that key switch defined zone may be used to arm or disarm.

NOTE: Do not define a maintained key switch zone for supervisory/trouble conditioning.

CONTROL STATION WIRING (TERMINALS 6, 7, 8, 9)

The control stations connect to the control terminals using only a four conductor cable. Four conductor, 22 gauge solid (or larger) jacketed cable is satisfactory for this hook-up, however, stranded wire provides additional resistance to bending and breakage. A shielded cable with the control end connected to earth ground provides additional protection from lightning. Connect the four control station wires as indicated in Table 2 below.

The total number of control stations that may be used per system varies, depending upon the total current drain from terminal 4 (Switched Smoke Power), terminal 5 (Auxiliary 2 Power), terminal 7 (Keypad/Auxiliary 1 Power), and connector J15. To determine the maximum number of control stations per system, add the total continuous current drains upon terminals 3, 4, 5, 7, and J15 and add 50mA for each control station to be used. This total should not exceed the limits as indicated in Table 10, page 42.

Z900ST/Z900R/Z700R KEYPAD WIRE COLOR	FUNCTION	Z900 CONTROL TERMINAL
BLACK	NEGATIVE	6
RED	POSITIVE (+12VDC)	7
GREEN	DATA IN (REMOTE)	8
WHITE	DATA OUT(REMOTE)	9

TABLE 2 Z900 CONTROL STATION WIRING

** See U.L. Notes in Section 5.

CONTROL STATION MOUNTING

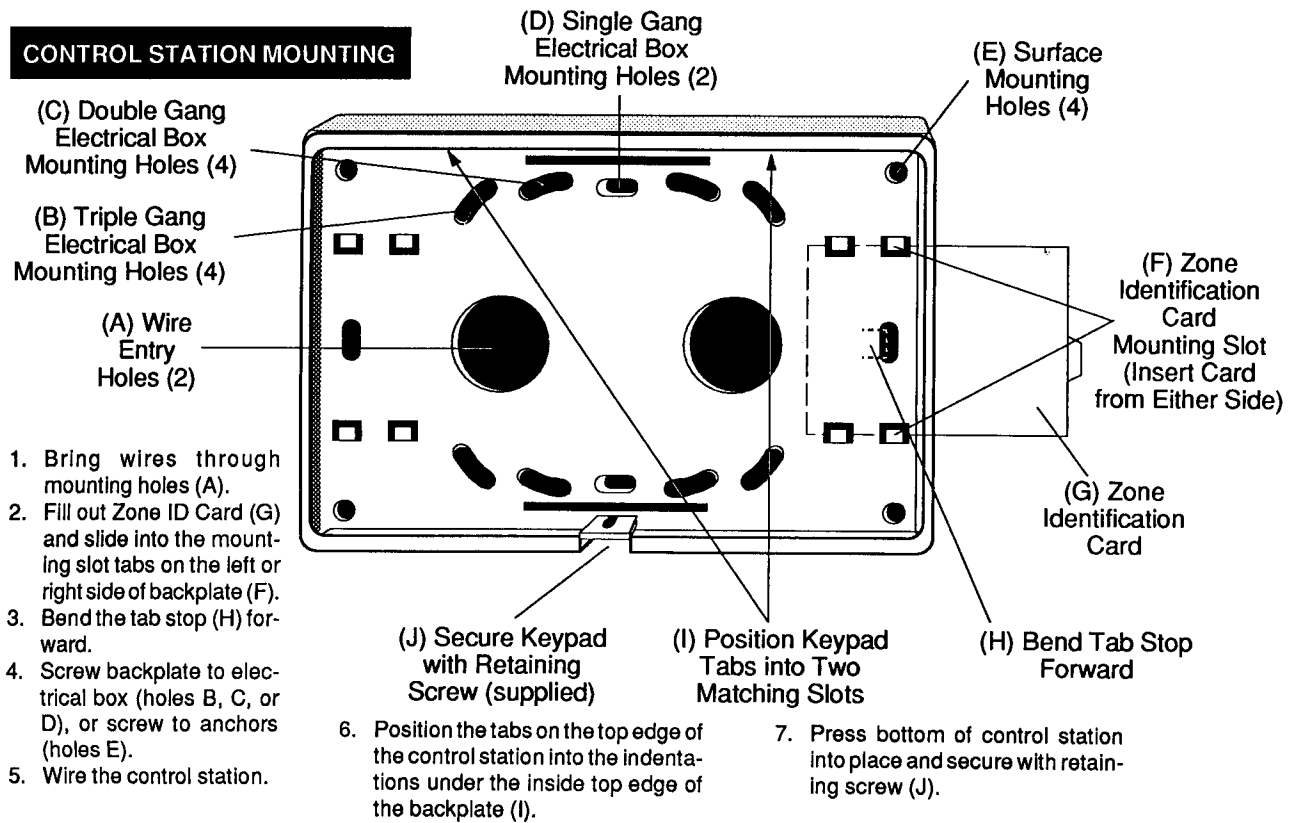

FIGURE 9 Z900R MOUNTING

❑ TROUBLESHOOTING

If a control station is incorrectly wired, the following symptoms will appear:

- Red Wire removed or cut:** No control station LED's. Sounder pulses rapidly. Control station will not accept key entries.
- Black Wire removed or cut:** All control station LED's flash rapidly. Sounder pulses rapidly. Control station will not accept key entries.
- Green Wire removed or cut:** Trouble LED lights steady. Control station will not accept key entries.
- White Wire removed or cut or Green/White Wires reversed:** Control station LED's scroll from bottom to top.

CONTROL BOARD FUSES

❑ FUSE F1

Fuse F1 is a 5mm x 20mm, 2.5 Amp, standard acting fuse. It is used to protect the Auxiliary 2 (terminal 5) output and the Assignable Output (terminal 3). If this fuse should ever blow, the control stations' "Trouble" LED will light. Upon pressing and holding the "2" Key for three seconds, the Zone 2 LED ("Low battery/Blown fuse") will light. The communicator will report a "Low battery/Blown fuse" condition to the central station (if so programmed).

❑ FUSE F2

Fuse F2 is a 5mm x 20mm, 2.5 Amp, standard acting fuse. It is used to protect the Keypad Power/Auxiliary 1 output (terminal 7) and Switched Power (terminal 4). If this fuse should ever blow, the control stations will become inactive but the communicator, if programmed, will report a "Low battery/Blown fuse" condition to the central station.

❑ BATTERY LEAD FUSE

A 4 Amp "pigtail" fuse is provided in the positive battery lead to protect the battery. If this fuse should blow, the printed circuit board must be returned to the factory for repair.

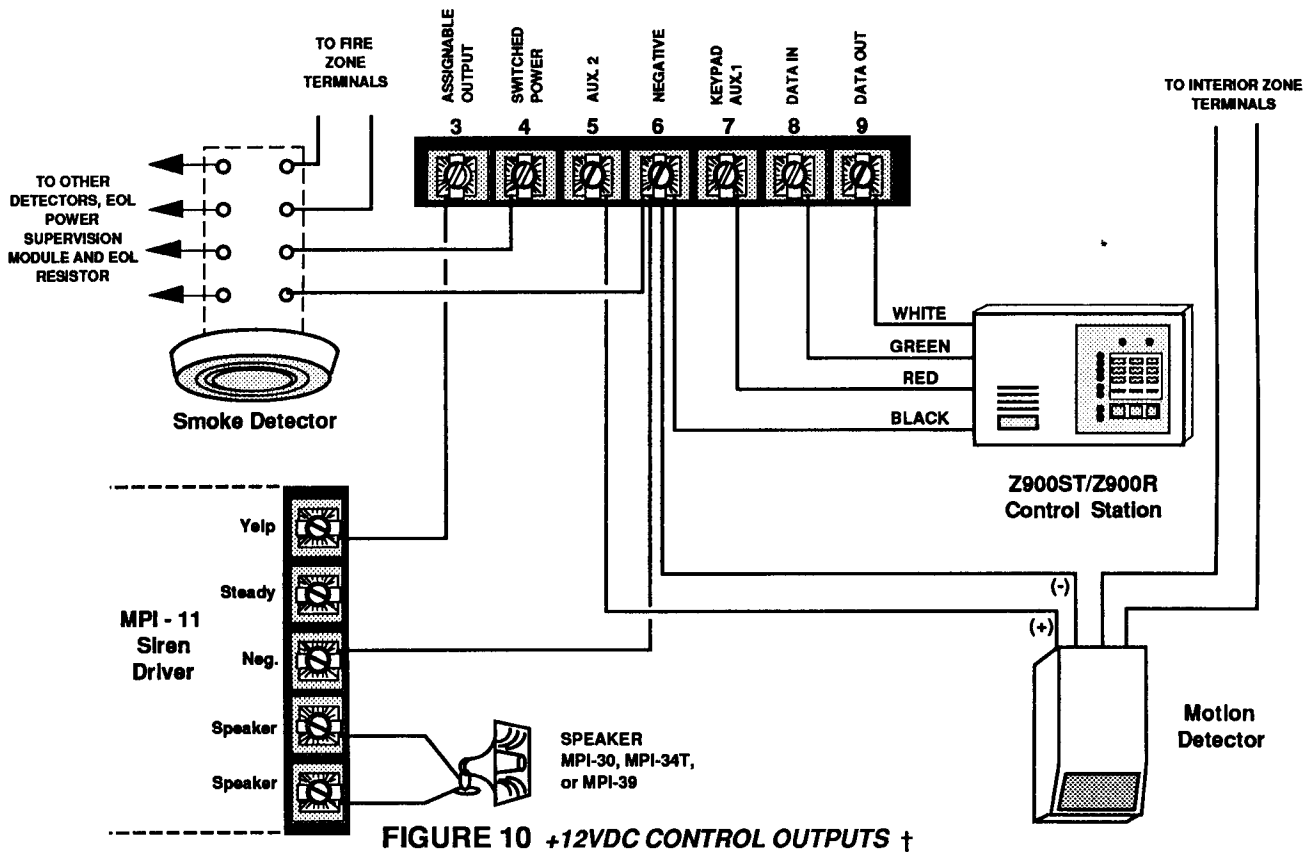

FIGURE 10 +12VDC CONTROL OUTPUTS †

12 VDC OUTPUTS

The control is supplied with one Assignable output, two Auxiliary Power outputs, and one Switched Power output.

□ SWITCHED POWER (Terminal 4)

Provides (+)12volts DC power for smoke detectors (see ff note on page i) and other devices that require momentary power interruption to reset. The power from this output can be momentarily interrupted to reset smoke detectors by pressing the “7” key and holding for three seconds. Each time the control does an automatic 24 hour test, power from this output will be removed for 5 seconds. For this reason, Switched Power should not be used to power any device that will trigger an alarm upon interruption and restoral of power. This output is fused at 2.5 amperes by fuse F2 which is also used to fuse the Keypad Power/Auxiliary 1 output (terminal 7). Do not exceed the current drain limitations as indicated in Table 10, page 42. See Figure 10 for a hook-up example.

□ AUXILIARY 2 (Terminal 5)

Used to provide (+)12 volts DC power for motion detectors and other devices requiring uninterruptable power. This output is protected by a 2.5 ampere fuse (F1) which is also used to fuse the Assignable Output (terminal 3). Do not exceed the current drain limitations as indicated in Table 10, page 42. See Figure 10 for a hook-up example.

□ KEYPAD POWER/AUXILIARY 1 (TERMINAL 7)

Used to supply (+)12 volts DC power for control stations. This output is fused at 2.5 amperes by fuse F2 which is also used to fuse the Switched Power output (terminal 4). This output may also be used to supply auxiliary power for motion detectors and other devices provided the total current draw does not exceed the limits as set by Table 10, page 42. See Figure 10 for a hook-up example.

† Maximum continuous current drain from terminals 3, 4, 5, 7 and connector J15 should not exceed the limits as specified in Table 10, page 42. Maximum current drain under alarm conditions should not exceed 1.5 Amps. When replacing fuses, always use 5 x 20 mm, 2.5 Ampere standard acting fuses. For U.L. Installations, use only U.L. listed audble devices and wire as indicated in Figure 4.

□ ASSIGNABLE OUTPUT (Terminal 3)

Assignable through programming (Function 256) to provide a (+) 12volt DC output upon any or all designated alarm conditions. If this output is not used for output upon alarms, it may be assigned to any ONE of the following other conditions: Switched Power reset (key 7)/24 hour automatic tests, access activation, supervisory/trouble conditions, or entrance pre-alarms and chime (key 6). If used to provide output upon alarms, it then must be defined as to the type of alarm condition(s) that will activate this output. This may include Burglar, Auxiliary "A", Auxiliary "B", or Auxiliary "C" alarms (or any combination) as selected through programming Functions 257-260. Sirens, bells, or other output devices may be connected directly to the Assignable Output (terminal 3) of the control provided they do not exceed the current drain limitations as indicated in Table 10, page 42. It may be desired to use this output for non-alarm conditions when using the optional Z729 Siren Driver/Output Expander **. This output is protected by a 2.5 ampere fuse (F1) which is also used to fuse the Auxiliary 2 output (terminal 5). See Figure 10, page 10 for a hook-up example.

Value Programmed (Function 256)	+12VDC Output from Terminal 3 upon:	Value of "1" Programmed In Function:	The Following "Alarm Conditions" Provide +12VDC Output:
0	Alarm Condition(s) as determined by Functions 257-260		
1	Sw. Power reset (Key 7)/Auto Tests	257	Burglary
2	Activation of Access	258	Auxiliary "A" (Fire ff)
3	Supervisory/Trouble Conditions	259	Auxiliary "B" (Police)
4	Entrance pre-alarms and Chime	260	Auxiliary "C" (Emergency)

TABLE 3 ASSIGNABLE OUTPUT (Terminal 3) DEFINITION

□ ADDITIONAL OUTPUTS

Additional alarm outputs and various other function outputs may be accessed by plugging in an optional Z729 Siren Driver/Output Expander **, and/or the optional Z229A Output Expansion Module ** into connector J15 at the top of the control board.

The Z729 Siren Driver/Output Expander provides a built-in two channel high power siren driver, additional access to common(-) and Auxiliary 1(+), and 10 other outputs to include: individual output for each type of alarm (Burglar, Auxiliary "A", "B", and "C"), plus "Armed", "Ready", "Violation", "Pre-Alarm", "Lamp" and "Access". Each output provides 40 milliamps maximum current at 12 Volts DC and may be used to trigger low current relay boards such as the MPI-206SP Relay Board **, or any device that either consumes less than 40 mA or that has a low current trigger input. A 12 pin plug in type connector with color coded flying leads is provided. These outputs are identical to those provided by connector J16 on all Z1100 series control panels. The built-in siren driver is preconfigured to provide "yelp" output for Burglar and Auxiliary "B" (Police) alarms and steady sound for Auxiliary "A" (Fire ff) and Auxiliary "C" (Emergency) alarms.

The Z229A Output Expansion Module may be used in one of two ways.

1. It may be plugged into the Z729 to provide 10 additional outputs as follows: "Zones 1-6 Alarm Status", "Supervisory/Trouble", "Fail to Communicate", "Smoke Reset", "Listen-in", plus 7 other outputs to include: "Zones 1-6 Ready Status", and "Ground Start".
2. It may be used exclusively to provide the same 10 outputs as the Z729 plus the first 10 outputs as listed in number 1 above.

□ CONTROL STATION ACTIVATED PANIC ZONES

The control is provided with three control station activated emergency panic zones. Three panic keys are provided on Z900R keypads for (from left to right) Auxiliary "A" (Fire ff), Auxiliary "B" (Police), and Auxiliary "C" (Emergency) alarms. Each zone is activated by pressing its designated key and holding for three seconds (or pressing at least twice within three seconds). If desired, the control can be programmed to respond to single momentary keypresses by programming a value of "0" into Function 271. To report the conditions to the central station, program Functions 74-76 (Tel. No. 1) and/or 127-129 (Tel. No. 2). To disable a emergency zone from operation, program a value of "1" into Function 261 (disable panic key Aux. "A"), 262 (disable panic key Aux. "B"), and/or 263 (disable panic key Aux. "C"). To activate the Assignable Output (terminal 3), Function 256 (Assignable Output Definition) must be programmed with a value of "0" (activates upon Alarm conditions) and at least one of Functions 258-260 must be programmed with a value of "1" to address the type of alarm that will cause the Assignable Output to activate (see Table 3 above).

** See U.L. Notes in Section 5.

TELEPHONE LINE CONNECTION (TERMINALS 19 - 22)

Terminal 19 and 20 are the inputs for the incoming telephone line. Terminals 21 and 22 are outputs which go to the house phones. The telephone line runs through a line seizure relay within the control. Whenever the control is idle, this relay completes the connection. When the control needs to communicate with the central station, this relay disconnects the house phones from the system, leaving only the communicator connected to the incoming lines. This prevents communication interruption caused by picking up of a house telephone within the protected premises. For proper installation and to meet FCC requirements, an approved USOC RJ-31X or RJ-38X "Telephone Jack" and a mating 8 pin modular "Direct connect cord" must be installed. The purpose for this is to provide an isolation and disconnection point between the local telephone system and the control's Digital communicator for telephone company troubleshooting. An RJ-38X jack is a standard RJ-31X jack with a jumper installed between terminals 2 and 3 to allow a tamper loop for supervising the connection (See Figure 4, page 4). When ordering either jack the telephone company will need the following information:

1. Required Jack: USOC RJ-31X OR RJ-38X.
2. The telephone number of the line that jack is to be installed on.
3. Requested location at which jack is to be installed.
4. Digital communicator FCC Registration number: DLH66Y-12286-AL-E
5. Ringer Equivalence: 0.0B

NOTE: The Ringer Equivalence Number (REN) is useful to determine the quantity of devices you may connect to your telephone line and still have all of those devices ring when your telephone number is called. In most cases, but not all areas, the sum of the RENs of all devices connected to one line should not exceed 5.0. To be certain of the number of devices that you can connect to a line in your area as determined by the REN, contact your local telephone company.

6. Equipment manufacturer: Aritech Corp.

NOTE: Refer to the inside back cover of this manual for FCC Compliance and additional telephone company information.

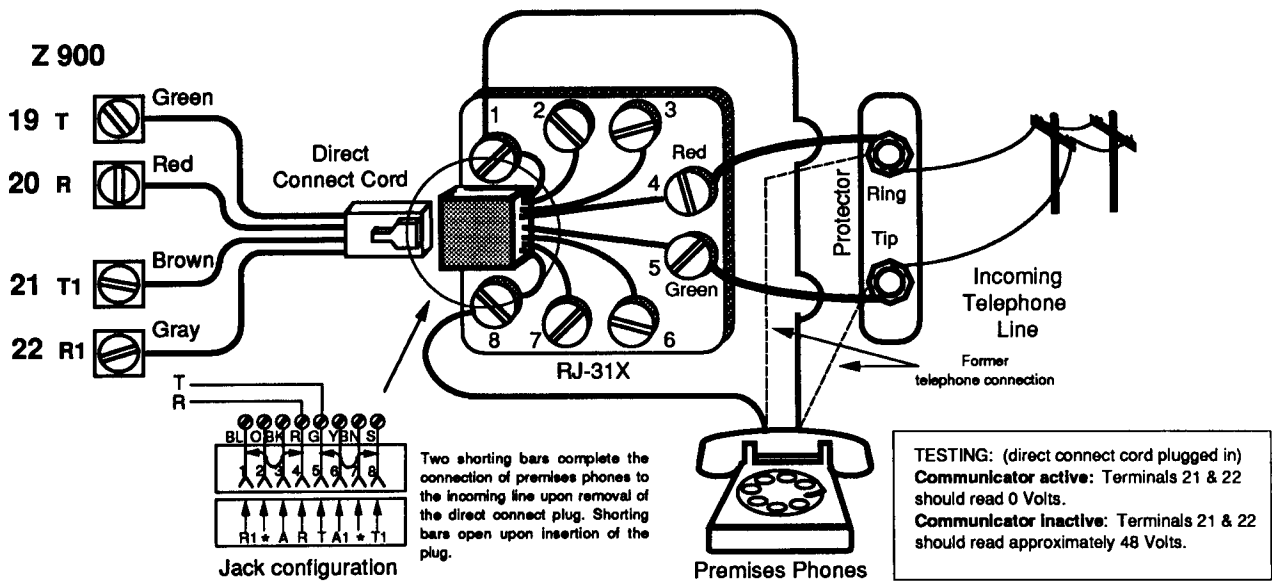

FIGURE 11 TELEPHONE SYSTEM CONNECTION

POWERING UP THE CONTROL

Before powering up the control, make certain that all connections are complete. This section assumes that the preceding sections have been read completely, that all wiring is complete, and the system is ready to be powered-up.

PROCEDURE

First, verify that the AC transformer and battery are plugged in and connected. The control will also power up with DC power only but the "Trouble" LED will light to indicate an "AC Failure" condition. The control stations will now display system status and emit a 2 second tone. If a control station does not power-up properly, pressing the " * " key will reset the control station microprocessor and allow it to begin working properly.

□ WATCHDOG MONITOR

The watchdog monitor is a circuit that constantly monitors the operation of the microprocessor and keeps it working properly. For example, if the control does not power-up properly, or if an internal problem occurs, the watchdog monitor will perform a restart of the microprocessor. A ROM and EEPROM check is then automatically made and the system returns to the same operating condition that it was in with the following exceptions:

1. If the system is armed, the control will ignore all burglar defined zones for fifteen (15) seconds (or as programmed in Function 188) once the watchdog restarts the microprocessor.
2. If the system is in alarm, the alarm output will cease and the control will re-arm.
3. If the system is communicating, the communication will be lost with the exception of alarm reports. Alarms are stored in non-volatile memory and will be re-transmitted.
4. The automatic communicator test clock will be reset to zero. If the system is programmed for test reporting, the test report will be sent when the system resets; thus notifying the central station of an out of sequence test. The test time reporting code is optional and is disabled from the factory.

□ AUTOMATIC SYSTEM DIAGNOSTICS UPON POWER-UP

Each time power is applied to the control, power-up diagnostics check the Read Only Memory (ROM) and the Electrically Erasable Programmable Read Only Memory (EEPROM). The EEPROM check is also made each time the control is armed/disarmed and during automatic communicator tests. The ROM check consists of compiling a checksum of all the ROM bits and comparing the results with the checksum produced when the ROM was manufactured. A difference in the ROM will lock up the microprocessor and cause the control station LEDs to scroll, from top and bottom to center. If this should occur, the microprocessor is defective and the control board must be returned to the factory for replacement. The EEPROM check consists of compiling a checksum of all the bits in the EEPROM and comparing this with the checksum generated when the EEPROM was last programmed. A difference in the checksums will result in a memory error. This condition will be annunciated by a continuous beeping at the the control stations and an illuminated "Trouble" LED. Pressing the "2" key and holding for three seconds will cause the Zone 5 ("Memory Error") LED to illuminate. The beeping of the stations may be silenced by pressing the " * " key. When an error has been detected, the Function Map should be read to determine the location of the change in information. The lighted "Trouble" LED on the control station will clear upon proper exiting of the programming mode.

PROCESSING OF ALARMS FOLLOWING TOTAL POWER LOSS

If a total power loss occurs (both AC and Battery) while the control is armed, the control will ignore all burglar defined zones for fifteen (15) seconds once the power is restored. The delay is to allow time for devices such as motion detectors, glass break sensors, etc., to power-up and stabilize. This time may be increased to 181 seconds (Function 188) if necessary to accomodate detectors which require longer stabilization time. This time is also started whenever the microprocessor is reset by the watchdog circuit. If a total power loss occurs while the digital communicator is transmitting, any hardwire activated zone alarms which have been stored in the EEPROM will be reported upon power restoral.

NOTE: Keypad activated alarms as well as supervisory/trouble, opening/closings, restorals, cancels, and test reports are not stored in EEPROM and therefore, will be lost in the event of total power loss.

THE Z900R CONTROL STATION

The Z900R was designed with ease of user operation in mind. A red "Armed" LED blinks upon exit delay and lights steady when the control arms. A green "Ready" LED lights steady if all hardwire zones are secure (even if faulted zones are shunted) and goes out if one or more zones are faulted. Each hardwire zone has a corresponding zone status indicator. If the green "Ready" LED is off, the corresponding faulted zone LED(s) will light. If a zone is shunted, the corresponding zone LED will blink, even if shunted by turning the interior defined zones off (see "Interior ON/OFF"). A separate "Alarm" LED illuminates simultaneously with the alarmed zone LED to provide alarm memory identification. A "Trouble" LED lights if service is required (a blown fuse, communication failure, EEPROM error, etc.). (See "Defining 'Trouble' Conditions", page 16). Arming and disarming is accomplished by entering a four digit code. Up to six *User Authorization Codes* may be programmed. Each code may include any digit sequence from 0001 - 9999. User Authorization Code one is the *Master User Authorization Code*. This code is also used to provide access to *User Level Programming*. Any code may be further defined as a *High Security Arm/Disarm Code*. When the system is armed with a High Security Arm/Disarm Code, the system cannot be disarmed by a non-high security code.

CONTROL STATION POWER-UP and SUPERVISION

Upon installation and power-up, each control station should be initialized with the control by manually pressing the " * " key. If a control station data wire is then tampered with, mis-wired, or broken, or if a control station is disconnected from the main control, the "Trouble" LED on any remaining controls stations will light. Pressing the "2" key (on an active control station) and holding for three seconds will cause the "Zone 3" (supervisory) LED to light. The digital communicator can also be programmed to report this condition to the central station. If the faulted control station still has power connected, the control station LEDs will scroll from bottom to top for local identification.

USER OPERATION

□ ARMING/DISARMING

Performed by simply entering an authorized four digit user code. Upon arming, the control station sounder will beep during the programmable exit delay time (Function 13). Upon entering the premises through a delay defined zone, the control station sounder will emit a steady pre-alarm tone during the programmed entrance delay time (Functions 11 and 12). The entrance and/or exit delay annunciation may be disabled if desired by programming odd time values. The arm/disarm codes are also used to reset all Auxiliary alarms and the control station activated zone. User codes (Functions 1-6) are programmable through User Level Programming only.

□ ALARM STATUS

If an alarm occurs, the "Alarm" LED will light and remain lighted until manually reset. If the alarm was triggered through a hardwired zone, the corresponding zone LED(s) will also light. For example, if an alarm occurs on Burglar Zone 4, then the "Alarm" LED and the "Zone 4" LED will illuminate. Upon disarming the control, these LEDs will remain lighted. Simply pressing the " * " key will turn the "Alarm" LED off. If the alarm was triggered through one of the control station activated zones, the red "Alarm" LED will light but no individual Zone LED will light, indicating that a non-hardwired zone alarm has occurred. Entering a valid user code will clear the alarm. Alarm memory information may be recalled even after resetting the alarm (see "Alarm Memory Retrieval", page 18).

□ MANUALLY RESETTING ALARMS

Burglar alarms:

The alarm may be reset by entering a valid user code. The communicator will continue to report the condition to the central station (if programmed) unless programmed to abort upon disarming (Function 54). The "Alarm" LED will remain lighted until reset by pressing the " * " key.

Auxiliary "A" (Fire ff) alarms:

Pressing the " * " key will silence the control station sounder. The Auxiliary "A" (Fire ff) alarm, which may be provided through the Assignable Output (terminal 3) and/or the Z729 Siren Driver/Output Expander, will also cease. The "Alarm" LED will remain lighted and the communicator (if programmed) will continue to report to the central station. Entering a valid user code will clear the alarm.

Auxiliary “B” (Police) alarms:

Pressing the “ * ” key will silence the control station sounder. The Auxiliary “B” (Police) alarm, which may be provided through the Assignable Output (terminal 3) and/or the Z729 Siren Driver/Output Expander will not be reset by pressing this key. Entering a valid user code will reset the alarm.

Auxiliary “C” (Emergency) alarms:

Pressing the “ * ” key will silence the control station sounder. The Auxiliary “C” (Emergency) alarm, which may be provided through the Assignable Output (terminal 3) and/or the Z729 Siren Driver/Output Expander, will also cease. The “Alarm” LED will remain lighted and the communicator (if programmed) will continue to report to the central station. Entering a valid user code will clear the alarm.

□ CONTROL STATION ACTIVATED PANIC ZONE OPERATION

The control is provided with three control station activated zones. Each zone is predefined for the type of alarm which it can initiate and is activated by pressing its designated emergency key. For added protection against false alarms, the control is programmed to ignore momentary keypresses and require a three second maintained keypress (or at least two momentary key presses within three seconds). If desired, the control can be programmed to respond to single momentary keypresses by programming a value of “0” into Function 271. The left most key is predefined to initiate an Auxiliary “A” (Fire) alarm, the center key can initiate an Auxiliary “B” (Police) alarm and the right key an Auxiliary “C” (Emergency) alarm. Self-adhesive labels are included with the control station for labeling these keys with symbols to indicate Fire, Police, and Medical conditions. Any or all control station zones may be disabled through programming (Functions 261-263). The Assignable Output (terminal 3) may be programmed to provide +12VDC upon activation and the communicator may also be programmed to report (refer to “Control Station Zones”, page 11 for more information).

When a control station zone is activated, the station beeps and the “Alarm” LED lights. The control station may be silenced by pressing the “ * ” key. If the zone is defined as an Auxiliary “A” or “C” zone, pressing the “ * ” key will also silence the Assignable Output (terminal 3) and the output from the optional Z729 Siren Driver/Output Expander, if so assigned. The alarm may be reset by entering a valid user code. The control station activated zone may be programmed to report the alarm to the central station. Auxiliary “B” may be programmed to be visually and audibly “silent” at the control station when activated.

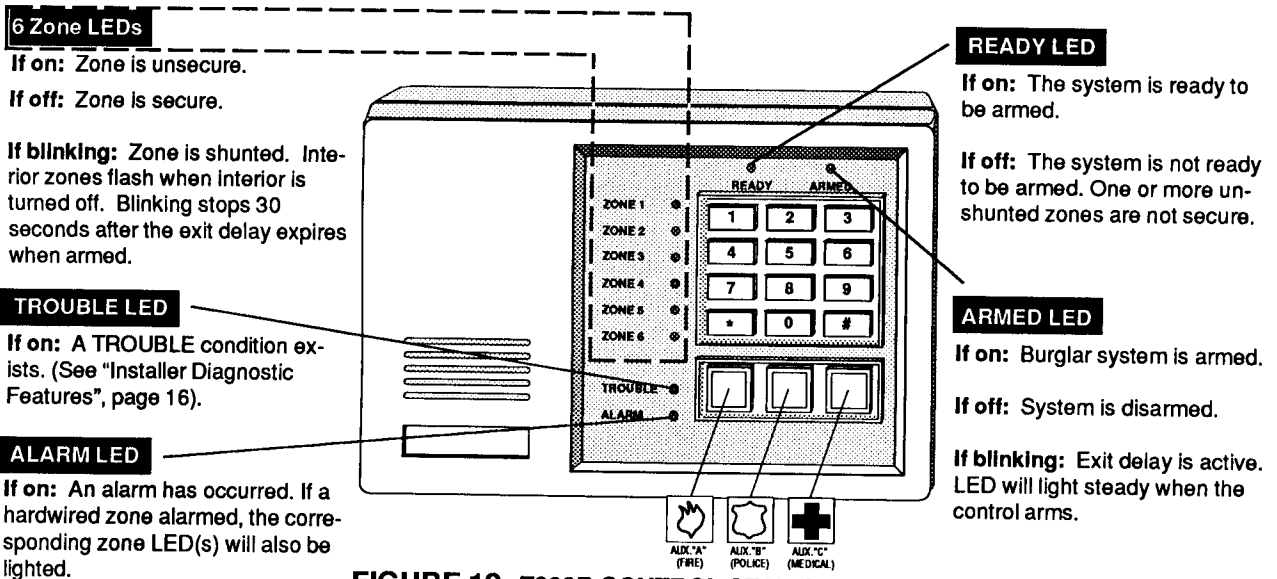

FIGURE 12 Z900R CONTROL STATION LEDs

□ ZONE SHUNTING (BYPASSING)

Hardwire Burglar zones may be manually bypassed by pressing the “ # ” (SHUNT) key followed by the number of the zone to be shunted. Auxiliary “A”, “B”, and “C”, zones may be defined with the sub-option to allow them to be shuntable also. The control must be disarmed before shunts can be enabled. When zones are shunted, the appropriate “Zone 1-6” LED(s) will blink continuously. Pressing “ # ” followed by the number of a shunted zone will remove the shunt. Pressing “ # ” followed by “9” will remove all shunts. When the control is armed, the shunted zone LEDs will only blink for the first 30 seconds after the exit delay expires then go out. Zone shunting capability can be disabled through programming (Function 195).

NOTE: Refer to Section 5 for U.L. Listed System requirements

INSTALLER DIAGNOSTIC FEATURES

Certain control station keys provide access to special features designed primarily for use by the installer. However, the installer may at his or her discretion, explain certain available features to the user when necessary. Table 5, page 17 lists these features. Diagnostic information is obtained through the control station by pressing specific keys. Information is displayed through combinations of illuminated LEDs. Features accessed through keys 4, 6, 7, 8, and “*” may be disabled through installer programming. The Diagnostic Overlay template (supplied) aids in defining specific trouble conditions, alarm memory conditions, and zone definition.

□ IDENTIFYING “TROUBLE” CONDITIONS (KEY 2)

If a trouble condition exists, a “Trouble” LED will illuminate on the control stations. Pressing and holding the number “2” key for three seconds will cause one or more of the zone LEDs to light. Each zone LED corresponds to a specific “Trouble” condition. This procedure is simple enough to be performed by the user and communicated to the installer over the telephone for diagnosis. Table 4 explains the indicated conditions.

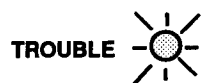

If the “Trouble” LED is lighted, press and hold the “2” key for three seconds. The control stations will beep three times and one or more zone LEDs will light to indicate the nature of the “Trouble” condition as explained below:

LIGHTED LED	INDICATED CONDITION CORRECTIVE ACTION REQUIRED
ZONE 1	AC Power Failure. Check transformer terminals 1 and 2 for presence of 16.5 VAC (no load) power.
ZONE 2	Low Battery/Blown Fuse. Check fuses F1 and F2 and condition of standby battery.
ZONE 3	Supervisory/Trouble. A supervisory defined zone is shorted or open (depending upon programming of Function 203-208).
ZONE 4	Fail to communicate. The control attempted to communicate with the central station but failed. Press the “*” key to silence the control station sander. See Function 48, page 27 for more information.
ZONE 5	Memory Error. Program information stored in the EEPROM has changed. See “Powering Up The Control”.
ZONE 6	Missing Keypad. A control station data wire has been removed from the control.
	<i>The following conditions do not require the “Trouble” LED to be lighted. Press the “2” key and hold for three seconds in the same manner as above to obtain the following ON or OFF LED indications:</i>
ALARM	Chime on. The Chime (Monitor) feature is active.
READY	Interior OFF. The interior defined zones are turned OFF (bypassed). They may be reinstated by pressing and holding the number “4” key for three seconds. Turning the interior off may also automatically disable the entrance delay, if so programmed (Function 191).
ARMED	Delay OFF. The Entrance Delay assigned to Entrance Delay 1 and 2 defined zones has been turned OFF simultaneously with the interior. This is a selectable programming option (see Function 191).

TABLE 4 TROUBLE DEFINITION

KEY NUMBER	FEATURE PROVIDED
2	Trouble Status: If a problem exists within the system, a dedicated control station LED labeled "Trouble" will light. Pressing and holding this key for three seconds will cause one or more control station LEDs to light to further define the trouble. This function exits automatically after 8 seconds of no key entries. See page 16.
3	Alarm Memory: Pressing and holding this key for three seconds will obtain a display identifying the zone that triggered the last alarm condition (see page 18). Upon entry of this mode, the control stations will beep three times. The control automatically exits this mode after eight seconds. Programming Function 009 clears Alarm Memory.
4	Interior ON/OFF: All Interior defined zones may be shunted by pressing and holding the number "4" key for three seconds. The corresponding Interior defined Zone LEDs will then blink to indicate that they are shunted. (See "Zone Shunting", page 15). These zones are returned to operation by repeating the process. The control stations beep three times whenever this feature is turned on or off to notify the user of system acceptance. The entrance delay may also be automatically disabled whenever the interior is turned off depending upon programming of Function 191. The interior and delay on/off status may be verified by pressing and holding the "2" key for three seconds. If the interior is selected off, the green "Ready" LED will light. If the Delay is off, the red "Armed" LED will also light. Upon disarming the system, the interior zones may be automatically defaulted to on or off (along with the delay if so programmed) depending upon programming of Function 194. The Interior on/off key may be disabled through installer programming (Function 196) if desired.
6	Chime: Pressing and holding the number "6" key for three seconds will activate the Chime (Monitor) feature. The control stations will beep three times to signify that the Chime has been turned on. When enabled, the control stations will beep twice whenever a non-interior Burglar defined zone is violated (with the control disarmed). This is commonly used as a door chime on commercial applications and to indicate that children have opened a door or window on residential applications. The Chime is turned OFF by repeating the process. The control stations will beep twice to signify that the Chime has been turned OFF. The Chime feature may be disabled through programming (Function 197) if desired.
7	Switched Power Interrupt: Pressing and holding this key for three seconds will cause the control to temporarily interrupt the output from Switched Power (terminal 4) for five seconds, in order to reset smoke detectors and other latching devices. Switched smoke power should not be used to power devices that may trigger an alarm upon interruption and restoral of power as power is momentarily removed once every 24 hours when the automatic system test is performed. This feature may be disabled through programming (Function 198).
8	Test: Press and hold this key for three seconds to enter the Test mode. The control stations will beep three times to signify entry. Each time a zone is violated, the corresponding zone LED will light and remain lighted until manually exiting this mode. This allows for a "tally" of zones tested. This mode is exited by pressing and holding the "8" key once again or pressing the " * " key. The manual test feature may be disabled through programming (Function 199).
9	Program: Used to enter the programming mode. See Section 3 for more information.
0	Access ** : Press and hold for three seconds then enter an assigned user code to provide an output for Access (door release, etc.). To enable this feature a user code must be assigned a Configuration Digit of 2, 3, 5, or 7 (Function 34-39). The output may be obtained through the Assignable Output or optional Z729 Siren Driver/Output expander.
*	Reset: Used to clear improper key entries and to reset certain alarms (see page 14-15).
#	Zone Shunting: Zones may be shunted (bypassed) easily by pressing the " # " followed by the zone number (1-6) of the zone to be shunted. Pressing " # " then " 9" will remove all shunts. The shunting feature may be disabled through installer programming (Function 195) if desired. See page 15 for more information.

TABLE 5 SPECIAL CONTROL STATION FEATURES

** See U.L. Notes in Section 5.

□ ALARM MEMORY RETRIEVAL (KEY 3)

When an alarm condition occurs, the control stores a record of the alarm in memory. This information may be retrieved even after the alarm has been reset and the control station "Alarm" LED has been extinguished. To obtain a display indicating the most recent alarm, press and hold the "3" key for three seconds and observe the lighted LEDs. Use the Diagnostic Overlay card (supplied) to determine the type of alarm and the hardwire zone(s) (if applicable) that activated. The display will return to the normal status mode after eight seconds. Alarm memory conditions are displayed as follows:

Burglar alarm - The "Armed" LED will light. If the alarm was activated through a hardwire zone, the appropriate zone LED(s) will also light.

Auxiliary "A" (Fire) Alarm - The "Alarm" LED will light. If the alarm was activated through a hardwire zone, the appropriate zone LED(s) will also light.

Auxiliary "B" (Police) Alarm - The "Ready" LED will light. If the alarm was activated through a hardwire zone, the appropriate zone LED(s) will also light.

Auxiliary "C" (Emergency) Alarm - The "Trouble" LED will light. If the alarm was activated through a hardwire zone, the appropriate zone LED(s) will also light.

When another alarm condition occurs, the memory will be erased and replaced by the current information.

Programming the Control

3

All programming is stored in nonvolatile “EEPROM” memory. The control is shipped with a factory (default) program already installed. All programming options are referred to as Functions. The *Program Function Map* is a list of all *Functions* complete with their factory default values.

User Level Programming provides access to Functions 1-33, which primarily pertain to the everyday operation by the end user. The *Master User Authorization Code* (User Code 1) is required to enter the user level programming mode. This code also functions as a normal user code to arm/disarm and reset alarms. This code can only be changed through user level programming.

Installer Level Programming provides access to all installer level programming Functions (34-266) and user level programming Functions 7-34.

All Functions are listed in numerical order in the *Program Function Map*, complete with their factory default values and space provided to enter new information.

Both levels of programming may be entered locally from any control station. In addition, the control may be programmed remotely with the aid of a personal computer (see “Remote Programming”, page 23). To reduce on the job installation time, the program may be copied and transferred from other Z900 controls with an optional hand held MPI230 Chip Duplicator. The system may be easily returned to factory default at any time (see “Restoring the Factory Default Program”, page 21).

INSTALLER LEVEL PROGRAMMING

INSTALLER PROGRAM AUTHORIZATION CODE

To enter the programming mode, press the “9” key and hold for three seconds. The control will beep three times to signify acceptance. Now enter the Installer Program Authorization Code (96321 at default). All control station LEDs will blink continuously.

NOTE: If the first four digits of the Installer Program Authorization Code are programmed the same as any User Authorization Code (Functions 1-6), the Installer Program Code will be inoperative.

ENTERING INSTALLER LEVEL PROGRAMMING UPON POWER-UP

Upon power-up, the Installer Level Programming Mode may be entered directly by pressing keys “3” and “9” simultaneously. This must be performed within 60 seconds after applying power to the control. The power-up method may also be used when the Installer Program Authorization Code is unknown.

THREE MINUTE PROGRAMMING TIMER

A three minute timer is started upon entry into the programming mode. If no keys are pressed for a duration of three minutes while in the programming mode, the control will emit a two second error tone and the control will return to the normal operation mode.

PROGRAM FUNCTIONS

All programming options are called Functions. Each contains a specific value, which serves as an instruction to the control. Programming changes are accomplished by entering new values into chosen functions. The allowable *range* of a value contained in each function varies according to the specific type and purpose. For instance, most of the timer related functions (entry/exit, alarm cutoff, etc.) deal with either seconds or minutes and have a range of 1-255. Functions that are associated with the digital communicator such as the account number, report codes, and telephone number have a range of 1-15. Many functions are questions requiring a simple yes or no response. Since the microprocessor accepts only numbers, answers to these type functions must be in the form of a “0” for No or a “1” for Yes. The Program Function Map and Programming Functions and Descriptions sections provide additional information about each function as well as the allowable range of values.

NOTE: Refer to Section 5 for U.L. Listed System requirements

THE “ # ” (FIND) AND “ * ” (STORE) KEYS

Two special keys are used while in the programming mode. They are the “ # ” (FIND) and “ * ” (STORE) keys. While in the programming mode, any program function may be accessed by pressing the desired function number using the numeric keys and then pressing the FIND key. This key also serves as a (NEXT) key. When pressed without first pressing any of the number keys, the “ # ” key will advance programming to the (NEXT) consecutive function.

Example: Pressing 4 + 5 and then FIND jumps to program Function 45 and displays its current value.



After “finding” a program function, the value (data) which it contains will be displayed on the LEDs. The value may be changed by pressing the desired new value using the keys 0 - 9 and then pressing the STORE key. This key also serves as a (QUIT) key. When pressed without first pressing any of the number keys, the “ * ” key will automatically exit the programming mode.

Example: Pressing 7 + 3 and then STORE changes the current program Function value to a value of 73.



READING THE VALUE OF A FUNCTION

While in the programming mode the control stations display the value that is stored within each Function. Values are displayed in combinations of lighted LEDs on the control station. Using the Diagnostic Overlay card (supplied), read the values printed next to each lighted LED (“Key 3” side of card). The value for the currently displayed Function is determined by adding these values (see example below).

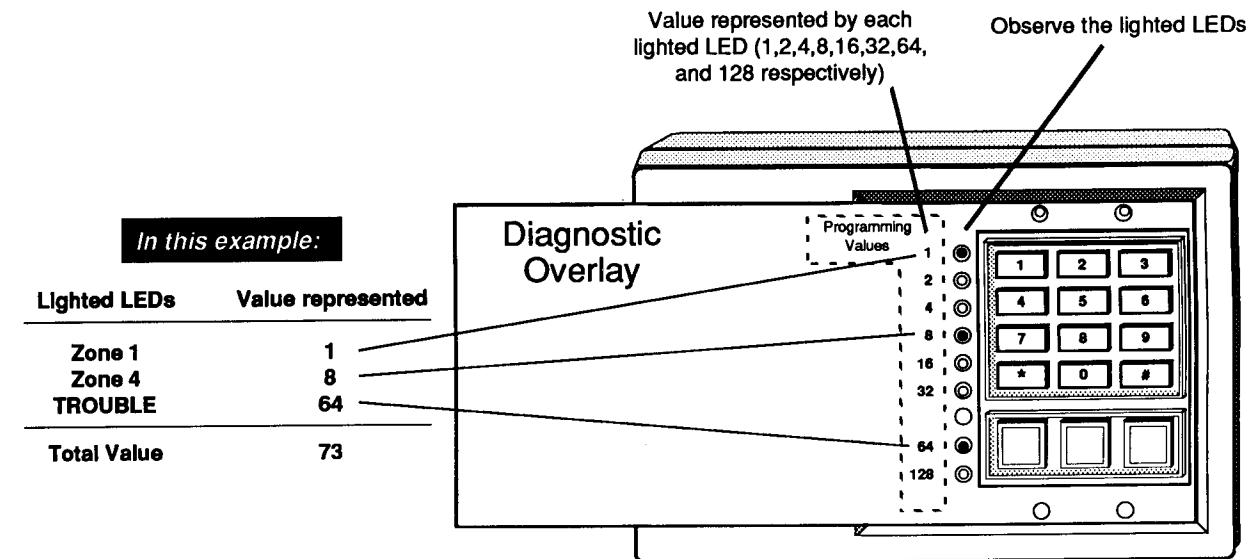

FIGURE 13 READING THE VALUE OF A FUNCTION

ZONE PLANNING GUIDE

Zones are programmed by selecting the desired zone type and definitions using the Zone Planning Guide (page D) as a worksheet. Each definition has a specific numeric value. After all selections are made, the individual values are added together and the total equals the value that should be programmed into the function for that zone.

PROGRAM FUNCTION MAP

Provides a list of each Function, its factory default value, and a blank space to write in any changes that may be desired. The map may be removed from the book and left inside the control for future references.

EXITING THE PROGRAMMING MODE

Pressing the “ * ” key twice exits programming mode.

INSTALLER LEVEL PROGRAMMING EXAMPLE



1. Press 9 and hold for three seconds. Three beeps.

2. Enter the Installer Program Code. (96321 at default) All LEDs flash.

3. Enter the desired Function number (1-3 digits). The current Function value will be displayed through the LEDs.

4. Press “FIND”. Two beeps. The value of the selected Function will be displayed through the LEDs.

NOTE: If Auto Answer is enabled, the Armed LED will light steady (See p.23).

NOTE: Ready and Armed LEDs continue to flash alternately throughout the programming mode.



5. Enter the new value. (A “1” represents “Yes” in this example. Possible entries vary for different Functions)

6. Press “STORE”. Two beeps. The new value is now stored in the EEPROM.

7. Press “NEXT” to step to the next location, or enter a new Function number followed by this key to “FIND” the selected Function.

8. Press the “ * ” key twice to exit the programming mode.

NOTE: Upon power-up the Installer Level Programming Mode may be entered directly by pressing keys “3” and “9” simultaneously, and then proceeding to step 3. Keys “3” and “9” must be pressed within 60 seconds of power-up. This method may also be used when the Installer Program Authorization Code is unknown.

FIGURE 14 INSTALLER LEVEL PROGRAMMING EXAMPLE

RESTORING THE FACTORY DEFAULT PROGRAM

The controls' factory default program may be easily restored at any time. Restoring the factory defaults automatically resets all installer level and user level program functions to the original default (factory pre-programmed) values. Restoring the default settings provides a quick means of erasing any bench testing programming prior to final installation. If the Master User Code is forgotten and restoring the entire program to default values is not desired, it may be restored individually through program Function 250. Refer to the Function Map for a complete listing of the default values.

1. Enter the installer level programming mode by following steps 1 and 2 in the example above. (If the code is unknown, press and hold keys “3” and “9” simultaneously for three seconds within 60 seconds of control power up). The control station LEDs will flash indicating entry into the programming mode.
2. Enter Function 254 and press the “ # ” (FIND) key.
3. Enter a value of “1” and press the “ * ” (STORE) key. The first LED (Zone 1) should now be lighted.
4. Press the “ * ” (STORE) key twice to exit the programming mode. There will be a 5 - 10 second delay while the control restores the factory default values. During this time the control will not respond to other commands. After approximately 5 - 10 seconds, the factory default values will be restored and the control will return to normal operation.

NOTE: Refer to Section 5 for U.L. Listed System requirements

USER LEVEL PROGRAMMING

User level programming provides access to programming functions which primarily pertain to the everyday operation by the user. Programming is performed in the same manner as with installer level programming with the following exceptions:

1. Access to user level programming is authorized by entering the Master User Authorization Code (User Code 1) rather than the Installer Program Authorization Code.
2. Programming is limited to Functions 1-33 only.
3. The “#” key will step to the “Next” digit of a multiple digit function (such as a user code) for reading the value of a function but this key will not advance programming to the “Next” Function. For example, after entering Function 002 (User Authorization Code 2), the first digit of the code will immediately be displayed. Pressing the “#” key will advance to digit 2. This digit is now displayed and the value can be determined. Repeat the process two more times to view digits 3 and 4. If pressed once more, user level programming is automatically exited.
4. Program mode is exited automatically after entering a new value.
5. The six user authorization codes (Functions 001-006) are accessible only through this level of programming.

MASTER USER AUTHORIZATION CODE

Along with performing normal Arm/Disarm functions, the Master User Authorization Code (Function 001) is also used to permit access to the user level of programming. This code is 1245 at factory default and may be changed to any other four digit code through user level programming. Do not use the same four digit code sequence as the first four digits of the Installer Program Authorization Code as this will make the Installer code inoperative. To enter the user level, press the 9 key and hold for three seconds. The control stations will beep three times to signify acceptance. Now enter the Master Program Authorization Code. All control station LED's will blink continuously.

USER LEVEL PROGRAMMING FORMAT

Perform user level programming in the same manner as explained earlier for installer level programming, substituting the Master User Authorization Code for the Installer Program Authorization Code. Functions 1-33 are accessible. Program mode is exited automatically after entering the new Function value.

USER LEVEL PROGRAMMING EXAMPLE



1. Press 9 and hold for three seconds. Three beeps.

2. Enter the Master User Authorization Code. (1245 at default) All LEDs flash.

NOTE: If Auto Answer is enabled, the Armed LED will light steady (See p.23).



3. Enter the desired Function number (1-3 digits). (“Exit Time in seconds” in this example). The current Function value will be displayed through the LEDs.

4. Press “FIND”. Two beeps. The value of the selected Function will be displayed through the LEDs.

NOTE: Ready and Armed LEDs continue to flash alternately throughout the programming mode.



5. Enter the new value. (45 seconds exit time in this example. Possible entries vary for different Functions)

6. Press “STORE”. Two beeps. The new value is now stored in the EEPROM.

7. The sounder will produce a 2 second tone as the control automatically exits the program mode and returns to the normal operating mode.

FIGURE 15 USER LEVEL PROGRAMMING EXAMPLE

SPECIAL PROGRAMMABLE FEATURES

REMOTE PROGRAMMING (UPLOAD/DOWNLOAD)

A powerful feature of the control is the ability to be re-programmed and/or controlled remotely over a standard telephone line using an IBM PC ® or compatible computer, a Hayes Smartmodem ® and the Aritech software package "TRANSPORT PC" ®. Each function of the control may be individually programmed while on line or the entire memory contents may be uploaded/downloaded with only a few keystrokes. An upload or download usually requires approximately 1 to 2 minutes. The software requires a licensing agreement contract. Contact the factory sales department for information. There are two methods of remote programming. The following is a description of each method along with the basic operation.

□ ON-SITE "MANUALLY" ASSISTED METHOD

Establish a telephone connection between the computer site and the telephone that is connected to the control. Select the "Answer" mode on the computer. Instruct the individual at the control to press and hold the "9" key for three seconds and enter their Master Authorization Code (default is 1245). All keypad LEDs should be blinking. After this is done, they should then select Function 33 and press the "#" (FIND) key. The control will seize the phone line and the control will report its status to the computer. When this is complete the control will await any re-programming commands. This method is the most secure method of remote programming since it requires assistance at the control panel site.

□ AUTO ANSWER AND CALLBACK METHOD **

This method requires two programming Functions to be set in order to operate properly. (1) Program Function 160 (Rings until auto answer) must have a value of 1 - 15. A value of "0" will disable auto answer. (2) Functions 161 through 176 must be programmed with the callback telephone number of the computer. The Function following the last telephone digit must be a value of "15". In operation, the computer dials the telephone number of the control. Upon detecting the programmed number of rings, the control will answer the call and produce a handshake signal. If the proper computer response is received, the control will hang-up and dial the callback telephone number. When the computer answers the callback, various security procedures take place before any programming information can be exchanged. These include: A security access code, computer operator security code, computer operator levels of access, as well as logging of all computer transactions. If the control does not receive the proper computer response or if the callback is not answered within a preset time limit, the control will reset to regular operation. The control will make a second attempt if the first attempt fails. This method virtually eliminates computer hackers from gaining access to the control. The "Alarm" LED will illuminate steady whenever the program mode is entered, once this feature is enabled.

NOTE: Both methods of remote programming have extensive built-in security features, however none are as important as proper operator screening and training to reduce the liabilities involved with this feature.

□ ANSWERING MACHINES

A Z233 Answer Command Module may be installed if the control is attached to a line which has a telephone answering machine. It allows the computer to signal the control when it wishes to communicate. When signaled, the control seizes the line and disconnects the answering machine. It then awaits for acknowledgement and makes the callback just as if it had answered the call.

SILENCE EXIT DELAY BEEP

The exit beep is silenced automatically when the system is armed with the interior off. This exit beep may be totally disabled by programming in an odd value when programming exit time (Function 13).

FORCE ARMING (See Program Function Descriptions, Function 178)

Z729 SIREN DRIVER/OUTPUT EXPANDER **

The optional Z729 Siren Driver/Output Expander plugs directly into connector J15 at the top edge of the control board to provide a built-in two channel high power siren driver plus outputs for Access, Pre-alarm, Ready (loop status), Armed, Violation, Burglar alarm, Auxiliary alarms ("A", "B" and "C"), and Lamp (to trigger line carrier house lamp switching devices upon pre-alarms, power failures, etc.). Additional access is provided to the controls' common negative termination and Auxiliary 2 (+12VDC).

** See U.L. Notes in Section 5.

NOTE: Refer to Section 5 for U.L. Listed System requirements

SUPERVISORY/TROUBLE ZONE SUB-OPTION **

Supervisory/Trouble is a programmable zone sub-option which allows Burglar, Auxiliary "B", Auxiliary "C", Communicator report only, and Keyswitch defined zones to react to either an open loop or shorted loop as a trouble instead of an alarm. A choice must be made as to troubles on opens or troubles on shorts. Troubles on loop opens is the factory default if a zone is defined as supervisory/trouble. Upon detection of a supervisory condition the control station will beep and display visual information and report the condition to the central station receiver if so programmed. The control station will continue to display a supervisory condition as long as the condition exists. When the supervisory condition is cleared, the control station will automatically reset unless the control has been programmed for latching supervisory (see Function 186) in which case it will be necessary to press the "*" key to silence and reset the control station. These loops must be configured as end-of-line resistor supervised loops (see Figure 6, page7) if this option is selected. If any burglar defined zones are to be programmed with the supervisory/trouble option, Function 248 (Eliminate Burglar Zone EOL Supervision) must be programmed with a "0" (disabled).

SHUNTABLE 24 HOUR AUXILIARY "A", "B", "C", COMMUNICATOR, AND KEYSWITCH ZONES **

The Auxiliary "A", "B", "C", zones, Communicator Report Only, and Keyswitch defined zones may be programmed as shuntable by adding a value of "32" to their base zone definition. Shunting may be performed manually utilizing the "# " key. Shunting of these zones may be valuable for servicing or in the event of a false alarming detection device.

NOTE: When an Auxiliary "A" (fire ff) zone is shunted, the control station will beep and display a supervisory/trouble condition. If the communicator is enabled and a code is programmed for supervisory/trouble reporting, a report will be transmitted. The control station can be silenced but the trouble condition will continue to be displayed until the shunt is removed and the zone secured.

PRIORITY (NON-SHUNTABLE) BURGLAR ZONES

For a higher level of security, all burglar zones can be individually programmed as non-shuntable. This is accomplished by adding "32" to the zone definition value when defining the zone.

HIGH SECURITY ARM/DISARM CODE

One or more of the user authorization codes may be programmed as a High Security Arm/Disarm Code by assigning a configuration digit of "4". Whenever the control is armed by a High Security Code, it can only be disarmed by that code or another High Security designated code. All other user codes are inoperable when the control is armed by a High Security Arm/Disarm Code.

GROUP SHUNTING **

One or more zones may be shunted simultaneously with a feature called "Group Shunting". After observing the faulted zones, press the shunt key ("# ") followed by an entry of "0". The faulted zones will automatically be shunted and the control station will automatically display which zones were shunted by blinking the corresponding LEDs.

DIGITAL COMMUNICATOR

The control has a built in communicator that can dial two (2) different 16 digit telephone numbers using either rotary or touchtone @ dialing. The report codes for all zones and transmitted conditions are programmable for each telephone number. By programming both telephone numbers and report codes identically, each telephone number can back-up the other if unsuccessful. Certain conditions may also be "split" between two different telephone numbers by programming selected report codes for each telephone number. Dual reporting of alarm and/or non alarm conditions, whereby signals are transmitted to both central stations is also possible (Functions 50 and 51).

TELEPHONE LINE SEIZURE

When the communicator is triggered, it seizes the telephone line, thereby disconnecting the house phones. Dial tone detection is then enabled. Once detected, rotary or touchtone @ dialing sequence begins, depending on programming of Function 67 and 120. If a dial tone is not detected within 10 seconds, the communicator hangs-up for the time set in Function 53 (factory default 3 seconds) and re-enables dial tone detection. If a dial tone is not detected within 10 seconds, the communicator will begin its dialing process anyway.

** See U.L. Notes in Section 5.

PROGRAM FUNCTION DESCRIPTIONS

Each programming Function is assigned a number from 1 to 271. These correspond directly to the numbers listed on the Program Function Map. A description of each function is provided in this section. Select those that are to be programmed, and write the values to be programmed onto the Program Function map. The pre-programmed (factory default) values are indicated in brackets [] on the Function map. If a Function is to be left at its default value, no programming will be required.

NOTE: Functions 1-6 may ONLY be accessed through user level programming. Functions 34 - 271 can ONLY be accessed through installer level programming. Functions 7 - 33 may be accessed from either user or installer level programming.

1 - MASTER USER AUTHORIZATION CODE

This is a dual purpose code. It may be used for arming/disarming and other day to day operation as determined by the assigned Configuration Digit, programmed through installer level (Function 34). It also functions as a programming authorization code to provide access to the user level of programming. This code is 1245 at factory default and may be changed at any time through user level programming. This code **MUST** be four digits in length. Digits may repeat within the code. This function is **NOT** accessible through installer level programming.

WARNING: Do not program a user code with the same digits as the first four digits of the Installer Program Authorization Code. This will cause the Installer Program Authorization Code to become inoperable.

2-6 - USER AUTHORIZATION CODES 2 - 6

User authorization codes are used to arm/disarm the control and provide other day to day operations as determined by the assigned Configuration Digit (Function 34-39). Each code **MUST** be four digits in length. Digits may repeat anywhere within the code. User codes 2-6 may only be programmed through user level programming. **SEE WARNING NOTE ABOVE.**

7 - USAGE COUNT CODE 6

User authorization code 6 performs the same function as user codes 2 - 5 except that the number of times that it can be used is controlled by Function 7. After the usage count expires, the code becomes inactive until a new usage count value is programmed into Function 7. Code 6 may also be programmed to be permanently active by selecting a value of 255 for Function 7.

8 - TIME UNTIL THE NEXT COMMUNICATOR TEST REPORT

This Function is used to select the time until the next automatic communicator test is reported to the central station. A report code must be programmed (Functions 89 & 142) in order for the communicator test to occur. The test report, if enabled, will be reported after the selected time expires and then routinely every 12 hours, or 1 to 7 days as specified by Function 20.

9 - CLEAR ALARM MEMORY

Entering this location will automatically clear the alarm memory. No value is required nor may be programmed in this location. If this location is entered through the Installer level, the “ * ” (STORE) key must be pressed to accept the entry.

10 - DELETE CODES

Entering this location followed by pressing the numeric keys (1 to 6) corresponding to a user authorization code, deletes the corresponding user code. Entering “ 0 ” deletes the installer program code (Function 255).

11 - ENTRANCE DELAY #1 TIME

Allowable time in seconds for entering through an “entry delay 1” defined zone and disarming the system without causing an alarm condition. Valid range is 1 to 255 seconds. An odd value will disable the control station prealarm sounder. Default is 30. **U.L. allows a maximum of 45 seconds.**

12 - ENTRANCE DELAY #2 TIME

Allowable time in seconds for entering through an “entry delay 2” defined zone and disarming the system without causing an alarm condition. Valid range is 1 to 255 seconds. An odd value will disable the control station prealarm sounder. Default is 46. **U.L. allows a maximum of 45 seconds.**

NOTE: Refer to Section 5 for U.L. Listed System requirements

13 - EXIT DELAY TIME

Allowable time in seconds for exiting through a delay or interior defined zone without causing an alarm. Valid range is 1-255 seconds. An odd value will disable the control station prealarm sounder. Default is 60. **U.L. allows a maximum of 60 seconds.**

14 - ACCESS ON TIME

Amount of time that the Access output will be active when an Access code is entered. In order for the control to provide access output, the Assignable Output must be programmed to produce +12 VDC upon Access activation (Function 256) or the Z729 Siren Driver/Output Expander must be used. Valid range for Function 14 is 1 to 255 seconds. Default is 5. A value of "0" will allow the access to switch on/off each time the code is entered.

15 - DELAY BURGLAR ALARM OUTPUT

Time in seconds that may be programmed to delay Burglar alarm output. Outputs may be obtained from the optional Z729 Siren Driver/Output Expander and the Assignable Output (terminal 3). Valid range is 0 to 255 seconds. Default is 0 seconds. **U.L. Note: Shall be programmed for "0" seconds.**

16 - BURGLAR ALARM CUTOFF TIME

Time in minutes that the Burglar alarm output will be active before automatic cutoff. Burglar alarm outputs may be obtained through the optional Z729 Siren Driver/Output Expander and the Assignable Output (if programmed). Valid range is 0 to 255 minutes. A value of "0" or "255" eliminates automatic cut-off. Default is 10 minutes. **U.L. requires a minimum burglar alarm time of 4 minutes for household and allows a maximum of 15 minutes.**

17 - AUXILIARY "A" (FIRE ff) CUT-OFF TIME

Time in minutes that the Auxiliary "A" (Fire ff) alarm output will be active before automatic cutoff. Auxiliary "A" alarm outputs may be obtained through the optional Z729 Siren Driver/Output Expander and the Assignable Output (if programmed). Valid range is 0 to 255 minutes. A value of "0" or "255" eliminates automatic cut-off. Default is 255 (no cut-off). **U.L. allows no automatic cutoff.**

18 - AUXILIARY "B" (POLICE) CUTOFF TIME

Time in minutes that the Auxiliary "B" (Police) alarm output will be active before automatic cutoff. Auxiliary "B" alarm outputs may be obtained through the optional Z729 Siren Driver/Output Expander and the Assignable Output (if programmed). Valid range is 0 to 255 minutes. A value of "0" or "255" eliminates automatic cut-off. Default is 10 minutes. **U.L. allows 4 minutes minimum.**

19 - AUXILIARY "C" (EMERGENCY) CUTOFF TIME

Time in minutes that the Auxiliary "C" (Emergency) alarm outputs will be active before automatic cutoff. Auxiliary "C" alarm outputs may be obtained through the optional Z729 Siren Driver/Output Expander and the Assignable Output (if programmed). Valid range is 0 to 255 minutes. A value of "0" or "255" eliminates automatic cut-off. Default is 10 minutes.

20 - TIME BETWEEN COMMUNICATOR TESTS

This Function specifies the time between each automatic communicator test report. This report may be programmed for every 12 hours or from 1 to 7 days. A value of "0" represents 12 hours and values of "1-7" represent days. **U.L. requires an automatic test to be performed at least once every 24 hours on commercial installations.**

21-32 - RESERVED FOR FUTURE USE (EXITS TO PROGRAMMING ENTRY MODE)

Entry into these locations will command the system to return to the point where programming mode was initially entered with all LEDs flashing.

33 - UPLOAD DATA TO A REMOTE LOCATION

This Function is used to perform a complete EEPROM memory upload to a remote location IBMPC® or compatible computer over ordinary telephone lines. This function requires the installation of a computer with special software to receive the data. Telephone contact must be made before Function 33 is activated. When this function is activated, the telephone line is seized and the data is uploaded. Transmission of data can be interrupted by depressing the " * " key for five seconds or until the system releases the telephone line. See "Remote Programming" on page 23 for details.

INSTALLER LEVEL PROGRAMMING ONLY BEYOND THIS POINT

34 - 39 - CONFIGURATION DIGITS FOR CODES 1 - 6

Each user authorization code is assigned a security level called a "Configuration Digit" (programming Function 34 through 39) which defines the operations that the code is authorized to perform. Select the appropriate configuration digit for each code desired and enter the values into the function map. Table 6 describes the configuration digits and describes the usage allowed by each.

DIGIT	DESCRIPTION
1	User code will Arm and Disarm the control.
2	User code will activate access output. †
3	User code will Arm/Disarm the control. "0" (held 3 seconds) followed by user code will activate the access output. †
4	High Security Arm/Disarm. When the control is armed by a High Security code, only that code or another High Security code can disarm the control.
5	User code will Arm and Disarm the control and activate access output simultaneously. †
6	Special Arm/Disarm. Same as configuration digit 1 with one exception. If the communicator is programmed for opening/closing reports, no report will transmit when this code is used to arm or disarm the control. Warning: If the control is armed by another code and a closing report is sent, the central station WILL NOT receive an opening if the control is later disarmed by a code which has a configuration digit "6".
7	User code will Arm and Disarm the control and activate access output simultaneously. Pressing "0" and holding for three seconds followed by the entry of a valid user code will activate access independently. †
8	NOT USED
9	User code will Arm and Disarm the control and transmit the duress code to central station receiver simultaneously.

TABLE 6 CONFIGURATION DIGITS

40 - FOR FUTURE USE - EXITS TO PROGRAMMING ENTRY MODE (SEE FUNCTION 21)

41 - 46 - ZONE 1-6 DEFINITION

These locations are used to define the 6 hardwired zones. Refer to the Zone Planning Guide (page D) and select the desired zone types by entering values of selected zone options and sub-options into the spaces provided. Add the values assigned to each zone and enter the totals for each zone into the respective Functions 41 - 46.

47 - COMMUNICATOR DISABLE AND DELAY

This function is used to activate or deactivate the communicator. If a value of "0" is entered the communicator will remain inactive. Any value of 1 to 255 will allow the communicator to enable after a delay of the same number in seconds. **U.L. requires that the communicator be enabled for either Local or Police Station Connected Burglar Alarm installations.**

48 - DIAL ATTEMPTS BEFORE SHUTDOWN (TELEPHONE NUMBER 1)

This Function sets the number of times that the communicator will attempt to dial the central station receiver using telephone number 1 before automatically shutting down if unsuccessful. Valid range is 1-15. **DO NOT PROGRAM WITH A VALUE OF "0"**. If the communicator is unsuccessful, the control stations will begin beeping and the "Trouble" LED will light to indicate a "Failure to Communicate" condition. Pressing the "*" key will silence the control station sounder. The "Trouble" LED will remain lighted until the communicator successfully establishes contact with the central station receiver and receives a handshake. The "Trouble" LED can also be reset by entering the program mode. The fail to communicate warning may be totally disabled for either telephone numbers by programming an odd value (1,3, etc.) for the dial attempts. **NOTE: U.L. requires 5 dial attempts minimum, 10 dial attempts maximum. An even value (6, 8, etc.) shall be selected to enable the Fail to Communicate.**

† **NOTE: The Access output may be provided from the optional Z729 Siren Driver/Output Expander or through the Assignable Output (if programmed). See page 10 and 11.**

NOTE: Refer to Section 5 for U.L. Listed System requirements

49 - DIAL ATTEMPTS BEFORE SHUTDOWN (TELEPHONE NUMBER 2)

This function sets the number of times that the communicator will attempt to dial the central station receiver using telephone number 2 before automatically shutting down if unsuccessful. Valid range is 1-15. See Function 48 for additional information. **NOTE: U.L. requires 5 dial attempts minimum, 10 dial attempts maximum. An even value (2, 4, etc.) shall be selected to enable the Fail to Communicate. DO NOT PROGRAM WITH A VALUE OF "0".**

50 - DUAL REPORT OF ALARMS

Enabling this feature permits reporting of selected alarm conditions to two central stations. For example, if Keypad Panic conditions are desired to be reported to two central stations, reporting codes for both "Keypad Panic/ Telephone Number 1" (Function 74) and "Keypad Panic/ Telephone Number 2" (Function 127) must be programmed, and a value of "1" must be programmed in Function 50 to enable Dual Reporting. If this option is not selected, the communicator will use telephone number 2 only as a back-up if communication through telephone number 1 was unsuccessful. A value of "1" in Function 50 instructs the communicator to report all alarm conditions (that are programmed to report) to the central station by dialing each telephone number. All Zone 1-6 alarms, Keypad Panic, Duress, Cancel, Zone Restore, and Supervisory/Trouble conditions are considered "Alarm" conditions.

51 - DUAL REPORT OF NON-ALARMS

Enabling this feature permits reporting of selected non- alarm conditions to two central stations. For example, if low battery conditions are desired to be reported to two central stations, reporting codes for both "Low Battery/Telephone Number 1" (Function 84) and "Low Battery/Telephone Number 2" (Function 137) must be programmed, and a value of "1" must be programmed in Function 51 to enable Dual Reporting. If this option is not selected, the communicator will use telephone number 2 only as a back-up if communication through telephone number 1 was unsuccessful. A value of "1" in Function 51 instructs the communicator to report all non-alarm conditions (that are programmed to report) to the central station by dialing each telephone number. Non-alarm conditions include Opening, Closing, Shunted Zone, Low Battery, Battery Restore, AC Failure, AC Restore, Memory Error, and Automatic Test conditions.

52 - COMMUNICATOR ON-HOOK TIME

Time in seconds that the communicator will place the telephone line on-hook if no dial tone is detected. The line seizure relay remains closed during this period. Valid range is 1-15.

53 - TIME BETWEEN DIAL ATTEMPTS

Time in seconds between dial attempts if previous dial attempt was unsuccessful. The telephone line seizure relay releases the line during this time. Valid range is 1-255. **U.L. requires no more than 45 seconds for U.L. certified accounts.**

54 - ABORT COMMUNICATOR UPON DISARMING

A value of "1" in this location will allow the communicator transmission to be aborted upon entry of the arm/disarm code. A cancel report code can be sent upon abort by programming Function 81 and 134.

55 - DISABLE DIALER TEST ON POWER-UP

If a test report code (Function 89 and 142) is programmed, a value of "0" allows the communicator to dial the central station with a test report code whenever the system is powered-up or reset by the watchdog timer. A value of "1" disables this feature preventing a dialer test on power-up.

56 - EXCEPTION OPENING/SYSTEM RESTORE

A value of "1" causes the communicator to report the opening code (Function 78 and 131) ONLY when the system has been disarmed (reset) after an alarm. A value of "0" disables Exception Opening/Restore reporting. **U.L. Note: Shall be programmed as "0" in U.L. Listed Systems.**

57-60 - ACCOUNT NUMBER (TELEPHONE NUMBER 1)

Functions 57 to 60 store the 3 or 4 digit account number. Each digit of the account number is stored in a separate function beginning with function 57=digit 1, 58=digit 2, 59=digit 3, and 60=digit 4. Valid range is 0-15. A zero "0" signifies NO digit and must be programmed into Function 57 if only a three digit account number is desired. A 10 must be programmed to represent the number 0. Note: TRANSPORT-PC and some receivers interpret the numbers 10, 11, 12, 13, 14, and 15 as hexadecimal characters A, B, C, D, E, and F respectively.

61 - TRANSMISSION FORMAT (TELEPHONE NUMBER 1)

Enter a value of "0" to "7" to select the communicator transmission format for telephone number 1. Refer to Table 7 on the next page.

- 0 = Autobaud. Format 1 or 2 automatically selected based upon the handshake tone from the receiver.
- 1 = 1400 Hz. handshake, 1900 Hz. data, 10 baud. (Ademco, Adcor, FBI, Osborne Hoffman, Radionics, Silent Knight, Varitech, and Vertex, slow format).
- 2 = 2300 Hz. handshake, 1800 Hz. data, 20 baud. (DCI, FBI, Franklin, Osborne Hoffman, Sescoa, Varitech, and Vertex, fast format).
- 3 = 1400 Hz. or 2300 Hz. handshake, 1800 Hz. data, 40 baud. (Radionics superfast no parity).
- 4 = 1400 Hz. handshake, 1900 Hz. data, 15 baud. (Silent Knight fast format).
- 5 = Radionics BFSK® (1400 Hz. or 2300 Hz. handshake). (FBI, Radionics, and Varitech).
- 6 = Sescoa Model 3000, slow format.
- 7 = Sescoa Model 3000, fast format.

NOTE: See Section 5 for compatible U.L. Listed Receivers

TABLE 7 COMMUNICATOR TRANSMISSION FORMATS

62 - SINGLE ROUND REPORTING (TELEPHONE NUMBER 1)

Some older central station receivers can only receive one report per telephone call. A value of "1" instructs the communicator to hang up after each single report and redial the central station for each additional report. **NOTE: Extended reports cannot be used with single round reporting.**

63 - 4/2 EXTENDED TRANSMISSION FORMAT (TELEPHONE NUMBER 1) †

A value of "1" enables 4/2 Transmission format. This is a form of extended reporting whereby the account code, consisting of four digits, is transmitted followed by 2 additional digits. The first of these 2 additional digits represents the report code and the second represents the extended code.

64 - STANDARD 2 LINE EXTENDED REPORTING (TELEPHONE NUMBER 1) †

A value of "1" enables standard 2 line extended transmission format. In this reporting format, the central station will receive its report on two printed lines. The example below details a burglar report from zone 4 of customer account number 268. Zone 4 was programmed to report a code 3 "Burglary".

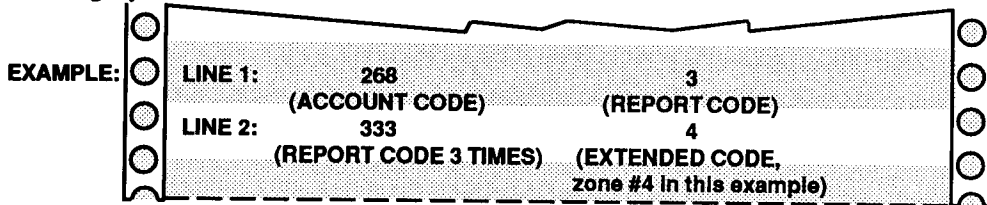

The central station will identify this as: Account 268, report code 3 (burglary) from zone 4.

FIGURE 16 2 LINE EXTENDED REPORTING EXAMPLE

65 - SINGLE LINE EXTENDED (RADIONICS A+) REPORTING (TELEPHONE NUMBER 1) †

This format is similar to standard extended format with the exception that report codes from 1 to 10 are not extended, while all codes from 11 ("B" hex.) thru 15 ("F" hex.) are. When transmitting to a Radionics or compatible receiver, the full report will be received and printed on a single line. In order for alarms, restores, etc. to be transmitted properly with this format, each zone report code must be programmed with the corresponding zone number respectively. When sending to Radionics type receivers, the following values will be printed as: 11 = OPENING, 12 = CLOSING, 13 = CANCEL(ABORT), 14 = RESTORAL, and 15 = TROUBLE.

- * When programming for Radionics Superfast (3) format, EITHER Extended Standard or Single Line Extended (Radionics A+) may be programmed but NEVER BOTH.
- ** When programming for Radionics BFSK (5) format, one CANNOT select Extended Standard, Single Line Extended (Radionics A+) or Parity Checksum (Radionics). The value of these functions must be programmed as "0".

66 - PARITY CHECKSUM (RADIONICS) (TELEPHONE NUMBER 1)

This function commands the communicator to transmit only one line of data containing the account and report code followed by a parity checksum digit for verification rather than sending each line of data twice. The system calculates the parity digit automatically by summing the total of the account and report codes. This feature is most commonly used when transmitting to Radionics receivers and transmission speed is generally faster and telephone connect time is reduced. A value of "1" enables this feature.

† **NOTE: Functions 63, 64, and 65 are mutually exclusive. Choose one only.**

NOTE: Refer to Section 5 for U.L. Listed System requirements

Z900 Specifications & Instructions

67 - TOUCHTONE ® DIALING (TELEPHONE NUMBER 1)

A value of "1" enables the communicator to dial using touchtone ®. A value of "0" enables rotary (pulse) dialing.

68-73 - ZONES 1 - 6 REPORTING CODES (TELEPHONE NUMBER 1)

Value programmed in each location represents the code that the corresponding hardwire zone will report to the central station receiver (Function 68 corresponds to zone 1, 69 to zone 2 etc.). Valid range is 0-15. A value of 0 disables reporting of the assigned zone.

NOTE: A reporting code of "0" is possible by entering a value of "10". TRANSPORT-PC and some receivers interpret values of "10" through "15" as hexadecimal codes "A" through "F".

74 - KEYPAD PANIC "A" (TELEPHONE NUMBER 1)

Code reported when the control station panic zone "A" is activated. Valid range is 0-15. A value of "0" disables reporting.

75 - KEYPAD PANIC "B" (TELEPHONE NUMBER 1)

Code reported when the control station panic zone "B" is activated. Valid range is 0-15. A value of "0" disables reporting.

76 - KEYPAD PANIC "C" (TELEPHONE NUMBER 1)

Code reported when the control station panic zone "C" is activated. Valid range is 0-15. A value of "0" disables reporting.

77 - DURESS REPORTING CODE (TELEPHONE NUMBER 1)

Code reported when a duress arm/disarm code is entered at the keypad. The extended reporting code which identifies the user is programmed in Functions 209 - 214. Valid range is 0-15. A value of "0" disables reporting.

78 - OPENING REPORT CODE (TELEPHONE NUMBER 1)

Code reported upon disarming the control. For exception opening see Function 56. The extended reporting code which identifies the user is programmed in Functions 209-214. Valid range is 0-15. A value of "0" disables reporting.

79 - CLOSING REPORT CODE WITH RINGBACK (TELEPHONE NUMBER 1)

Code reported upon arming the control. The extended reporting code which identifies the user is programmed in Functions 209-214. If this feature is selected, the control stations will beep six times followed by a two second error tone after a kissoff tone has been received from the central station receiver. Exit delay will then be restarted. Valid range is 0-15. A value of "0" disables reporting.

NOTE: When arming or disarming using a key switch zone, the system will report the opening or closing code followed by the extended code as programmed in Function 215 to identify that the keyswitch was used.

80 - SHUNT REPORTING CODE (TELEPHONE NUMBER 1)

Common code reported whenever the control is armed with a shunted zone. The extended reporting code which identifies the zone is programmed in Functions 228-233. Valid range is 0-15. A value of "0" disables reporting.

81 - CANCEL REPORTING CODE (TELEPHONE NUMBER 1)

Code reported when an alarm transmission is aborted. The extended reporting code which identifies the user is programmed in Functions 209-214. Valid range is 0-15. A value of "0" disables reporting.

82 - ZONE RESTORE REPORTING CODE (TELEPHONE NUMBER 1)

Code reported when a zone which caused the alarm is restored to operation. The extended reporting code which identifies the zone is programmed in Functions 222-227. Valid range is 0-15. A value of "0" disables reporting.

83 - SUPERVISORY REPORTING CODE (TELEPHONE NUMBER 1)

Code reported when a zone programmed for supervisory is activated. The extended reporting code which identifies the zone is programmed in Functions 234-239. Valid range is 0-15. A value of "0" disables reporting.

84 - LOW BATTERY/FUSE BLOWN REPORTING CODE (TELEPHONE NUMBER 1)

Code reported when a low battery (while AC is not present) or blown fuse is detected. The extended reporting code is programmed in Function 241. Valid range is 0-15. A value of "0" disables reporting.

85 - BATTERY/FUSE RESTORE REPORTING CODE (TELEPHONE NUMBER 1)

Code reported after the restoral of a low battery condition or blown fuse. The code is reported after adequate system power is detected (above 11.2 volts) during the 24 hour automatic test or after manually pressing the 7 key. The extended reporting code is programmed through Function 241. Valid range is 0-15. A value of "0" disables reporting.

86 - AC FAILURE REPORTING CODE (TELEPHONE NUMBER 1)

Code reported when AC power is interrupted for more than approximately 5 minutes. The extended reporting code is programmed through Function 240. Valid range is 0-15. A value of "0" disables reporting.

87 - AC RESTORE REPORTING CODE (TELEPHONE NUMBER 1)

Code reported when AC power is restored. The extended code is programmed in Function 240. Valid range is 0-15. A value of "0" disables reporting.

88 - EEPROM MEMORY ERROR REPORTING CODE (TELEPHONE NUMBER 1)

Code reported when an EEPROM memory error is detected. The extended reporting code is programmed in Function 242. Valid range is 0-15. A value of "0" disables reporting.

89 - COMMUNICATOR TEST REPORTING CODE (TELEPHONE NUMBER 1)

Code reported when the communicator performs a test. Time between tests is set in Function 20. The extended reporting code is programmed in Function 243. Valid range is 0-15. A value of "0" disables reporting.

90-105 - TELEPHONE NUMBER 1

Enter the number to be dialed for telephone number 1 in Functions 90 through 105. Valid range is 0-15. A value of "0" or 10 represents dialing digit "0". A value of "11" represents "*" and 12 represents "#", when using Touchtone® dialing. A value of "13" instructs the communicator to pause for three seconds before dialing the next digit. A value of "14" instructs the communicator to wait 10 seconds for a second dial tone. A value of 15 must be programmed in the location following the last dialing digit to signify end of dialing.

106 - AUDIO LISTEN-IN CAPABILITY (TELEPHONE NUMBER 1)

The monitoring central station can receive One (1) minute of audio listen-in immediately following a transmission from the Digital Communicator and the subsequent receiver "kiss-off" by connecting an amplified/filtered microphone to the listen-in post (see Figure 17, page 41) on the control board and then programming a value of "1" into this Function. In some cases, the microphone board must also be triggered. This may be performed by utilizing an output from the optional Z229A Output Expansion Module. (Consult technical services department for more information). U.L. NOTE: This Function shall be disabled in U.L. Listed Systems.

Note: Listen-In will only occur when telephone #1 calls the central station unless Function 159 (audio listen-in telephone #2) is also programmed with a "1". This can be a useful feature to "SPLIT" the operation of listen-in to a separate receiver.

107 - RESERVED FOR FUTURE USE - EXITS TO PROGRAMMING ENTRY MODE (SEE FUNCTION 21)**108 - COPY TELEPHONE NUMBER 1 ACCOUNT, FORMATS, AND REPORT CODES TO TELEPHONE NUMBER 2**

Entry into this location will command the system to copy all of the values in Functions 57-66 and 68-87 and duplicate them into Functions 110-119 and 121-126. No values may be programmed into this location.

109 - COPY TELEPHONE NUMBER 1 TO TELEPHONE NUMBER 2

Entry into this location will command the system to copy all of the values in Functions 90-105 and enter them into Functions 143-158. No values may be programmed into this location.

110-113 - ACCOUNT NUMBER (TELEPHONE NUMBER 2)

Functions 110 to 113 store the 3 or 4 digit account code. Valid range is 0-15. Please refer to Functions 57-60 for additional important information.

114 - TRANSMISSION FORMAT (TELEPHONE NUMBER 2)

Program the value in the same manner as Function 61.

115 - SINGLE ROUND REPORTING (TELEPHONE NUMBER 2)

Program the value in the same manner as Function 62.

NOTE: Refer to Section 5 for U.L. Listed System requirements

Z900 Specifications & Instructions

116 - 4/2 TRANSMISSION FORMAT (TELEPHONE NUMBER 2)

Program the value in the same manner as Function 63.

117 - STANDARD 2 LINE EXTENDED REPORTING (TELEPHONE NUMBER 2)

Program the value in the same manner as Function 64.

118 - SINGLE LINE EXTENDED (RADIONICS A+) REPORTING (TELEPHONE NUMBER 2)

Program the value in the same manner as Function 65.

119 - PARITY CHECKSUM (RADIONICS) (TELEPHONE NUMBER 2)

Program the value in the same manner as Function 66.

120 - TOUCHTONE® DIALING (TELEPHONE NUMBER 2)

A value of "1" enables the communicator to dial using touchtone ®. A value of "0" enables rotary (pulse) dialing.

121-126 - ZONES 1-6 REPORTING CODES (TELEPHONE NUMBER 2)

Value programmed in each location represents the codes that the corresponding hardwire zone will report to the central station receiver (Function 121 corresponds to zone 1, 122 to zone 2 etc.). Determine program values in the same manner as locations 68-73. Valid range is 0-15. A value of "0" for any selected location disables its reporting.

127 - KEYPAD PANIC "A" (TELEPHONE NUMBER 2)

Code reported when the control station panic zone "A" is activated. Valid range is 0-15. A value of "0" disables reporting.

128 - KEYPAD PANIC "B" (TELEPHONE NUMBER 2)

Code reported when the control station panic zone "B" is activated. Valid range is 0-15. A value of "0" disables reporting.

129 - KEYPAD PANIC "C" (TELEPHONE NUMBER 2)

Code reported when the control station panic zone "C" is activated. Valid range is 0-15. A value of "0" disables reporting.

130 - DURESS REPORTING CODE (TELEPHONE NUMBER 2)

Code reported when a duress arm/disarm code is entered at the keypad. The extended reporting code which identifies the user is programmed in Functions 209 - 214. Valid range is 0-15. A value of "0" disables reporting.

131 - OPENING REPORT CODE (TELEPHONE NUMBER 2)

Code reported upon disarming the control. For exception opening see Function 56. The extended reporting code which identifies the user is programmed in Functions 209-214. Valid range is 0-15. A value of "0" disables reporting.

132 - CLOSING REPORT CODE WITH RINGBACK (TELEPHONE NUMBER 2)

Code reported upon arming the control. The extended reporting code which identifies the user is programmed in Functions 209-214. If this feature is selected, the control stations will beep six times followed by a two second error tone after a kiss-off tone has been received from the central station receiver. Exit delay will then be restarted. Valid range is 0-15. A value of "0" disables reporting.

NOTE: When arming or disarming using a key switch zone, the system will report the opening or closing code followed by the extended code as programmed in Function 215 to identify that the key switch was used.

133 - SHUNT REPORTING CODE (TELEPHONE NUMBER 2)

Common code reported whenever the control is armed with a shunted zone. The extended reporting code which identifies the zone is programmed in Functions 228-233. Valid range is 0-15. A value of "0" disables reporting.

134 - CANCEL REPORTING CODE (TELEPHONE NUMBER 2)

Code reported when an alarm transmission is aborted. The extended reporting code which identifies the user is programmed in Functions 209-214. Valid range is 0-15. A value of "0" disables reporting.

135 - ZONE RESTORE REPORTING CODE (TELEPHONE NUMBER 2)

Code reported when a zone which caused the alarm is restored to operation. The extended reporting code which identifies the zone is programmed in Functions 222-227. Valid range is 0-15. A value of "0" disables reporting.

136 - SUPERVISORY REPORTING CODE (TELEPHONE NUMBER 2)

Code reported when a zone programmed for supervisory is activated. The extended reporting code which identifies the zone is programmed in Functions 234-239. Valid range is 0-15. A value of "0" disables reporting.

137 - LOW BATTERY/FUSE BLOWN REPORTING CODE (TELEPHONE NUMBER 2)

Code reported when a low battery or blown fuse is detected. The extended reporting code is programmed in Function 241. Valid range is 0-15. A value of "0" disables reporting.

138 - BATTERY/FUSE RESTORE REPORTING CODE (TELEPHONE NUMBER 2)

Code reported after the restoral of a low battery condition or blown fuse. The code is reported after adequate system power is detected (above 11.2 volts) during the 24 hour automatic test or after manually pressing the 7 key. The extended reporting code is programmed through Function 241. Valid range is 0-15. A value of "0" disables reporting.

139 - AC FAILURE REPORTING CODE (TELEPHONE NUMBER 2)

Code reported when AC power is interrupted for more than approximately 5 minutes. The extended reporting code is programmed through Function 240. Valid range is 0-15. A value of "0" disables reporting.

140 - AC RESTORE REPORTING CODE (TELEPHONE NUMBER 2)

Code reported when AC power is restored. The extended code is programmed in Function 240. Valid range is 0-15. A value of "0" disables reporting.

141 - EEPROM MEMORY ERROR REPORTING CODE (TELEPHONE NUMBER 2)

Code reported when an EEPROM memory error is detected. The extended reporting code is programmed in Function 242. Valid range is 0-15. A value of "0" disables reporting.

142 - COMMUNICATOR TEST REPORTING CODE (TELEPHONE NUMBER 2)

Code reported when communicator performs a test. Time between tests is set in Function 20. The extended reporting code is programmed in Function 243. Valid range is 0-15. A value of "0" disables reporting.

143-158 - TELEPHONE NUMBER 2

Program the number to be dialed for telephone number 2 in the same manner as programmed in Functions 90 thru 105.

159 - AUDIO LISTEN-IN CAPABILITY (TELEPHONE NUMBER 2)

A value of "1" will enable audio listen-in devices to activate for One (1) minute after receiving the receiver "kiss-off" when the central station is called using telephone #2. (See Function 106)

160 - NUMBER OF RINGS UNTIL AUTO ANSWER

The control may be programmed to automatically pick-up and answer the telephone line after 1 to 15 rings. This Function must be programmed in order for the "auto answer callback method" of remote programming to operate (See "Remote Programming", page 23). Valid range is 0-15. A value of "0" will disable the auto answer callback method.

161-176 - CALLBACK TELEPHONE NUMBER (REMOTE PROGRAMMING)

Enter the callback telephone number of the remote programming computer that the control is to dial when remote programming is enabled. Program the number to be dialed in the same manner as programmed in Functions 90 thru 105. Valid range is 0-15. A value of "15" must be programmed in the location following the last dialing digit. The automatic callback method of remote programming may be disabled by programming the first digit as "15". **U.L. Note: This Function shall be disabled by programming a "15" in U.L. Listed Systems.**

177 - TWO DIGIT ARMING

A value of "1" in this location will command the system to arm whenever the first two digits of a user authorization code are entered from a control station. The full code will still be required to disarm. **U.L. Note: Not to be programmed in U.L. Listed Systems.**

178 - ENABLE FORCE ARMING

A value of "1" in this location enables force arming. Force arming allows the control to arm even while a zone is faulted. When a user attempts to arm the system with a faulted zone, the control station will emit a 2 second error tone indicating that the control refused to arm. If the code is re-entered within 8 seconds after the tone quits, the control will "force arm" and the faulted zone(s) will be either temporarily or permanently bypassed, depending on the selection of Function 179. If the code is not re-entered within 8 seconds another error tone sounds to indicate that the allowed re-entry time has expired. **U.L. Note: This Function shall be disabled in U.L. Listed Systems.**

179 - TEMPORARY OR PERMANENT FORCE ARMING

A value of "0" in this Function selects "temporary" force arming which allows a zone that has been force armed to automatically be placed back into service when and if restored. A value of "1" selects "permanent" force arming whereby the zone will remain bypassed until the system is disarmed. **U.L. Note: This Function shall be disabled in U.L. Listed Systems.**

180 - DELAY BURGLAR ZONE RESTORE REPORT UNTIL ALARM CUT-OFF TIME EXPIRES

In normal operation, a restoral report, if programmed, is transmitted as soon as the zone restores. Entering a value of "1" in this location prevents the communicator from transmitting a restored zone report until after the alarm cut-off time has expired and the zone has restored. If restoral reports are not programmed, this function can still be used to limit transmissions in the event of a continuously triggering detection device. When this function is programmed, the violated zone cannot report another alarm condition until the alarm cut-off time has expired and the zone has restored.

181 - BURGLAR ALARM REPORTS UNTIL LOCKOUT

This function may be programmed to limit the maximum number of successful communicator burglar alarms (from 1 to 15) that may be reported during an armed cycle or timed period. When this value is reached, the communicator will not report another burglar alarm until the system is disarmed and reset or until the 24 hour based automatic test timer expires. This prevents a "runaway" condition which can be caused by a faulty zone or detector. **NOTE: This function effects ONLY burglar defined zone alarms and only locks out after the number of SUCCESSFUL reports. It has no effect on Functions 48 & 49. This Function will not work if Function 193 is also selected.**

182 - PULSING BURGLAR ALARM OUTPUT

A value of "1" instructs the Burglar alarm output to repeatedly pulse, one second on and one second off whenever a Burglar alarm is activated. This applies to outputs derived from the Assignable output (terminal 3) and the optional Z729 Siren Driver/Output Expander. A value of "0" programs the output to be steady. **U.L. Note: Shall be programmed to "1" for Pulsing Burglar Alarm in U.L. Listed Systems.**

183 - PULSING AUXILIARY "A" (FIRE ff) ALARM OUTPUT

A value of "1" instructs the Auxiliary "A" alarm output to repeatedly pulse, one second on and one second off whenever an Auxiliary "A" alarm is activated. This applies to outputs derived from the Assignable output (terminal 3) and the optional Z729 Siren Driver/Output Expander. A value of "0" programs the output to be steady. **U.L. Note: Shall be programmed to "0" for Steady Fire Alarm in U.L. Listed Systems.**

184 - BURGLAR LOOP AUDIBLE LOCKOUT

A value of "1" instructs the Burglar alarm output to function only once per arm/disarm cycle. This applies to outputs derived from the Assignable output (terminal 3) and the optional Z729 Siren Driver/Output Expander. The communicator, if enabled will continue to send reports as each zone is violated. **U.L. Note: This Function shall be disabled in U.L. Listed Systems.**

185 - MECHANICAL KEYSWITCH MODE CHANGE

A value of "1" in this location allows key switch change of Interior on/off from a key defined zone (see "Key Switch Zone", page 8).

186 - SUPERVISORY/DAY ALERT LATCH

A value of "1" commands the supervisory/trouble condition to latch on until manually cleared by pressing the " * " key .

187 - AUTOMATIC INTERIOR OFF

A value of "1" in this location commands the system to automatically switch the interior defined zones off at the expiration of the exit delay if no delay zones are violated during the exit time. This eliminates the user from having to manually turn interior off if staying in the building. The entrance delay will also be switched off at this time, if Function 191 ("Entrance delay off when interior off") is enabled.

188 - EXTEND BURGLAR LOOP DETECTOR STABILIZATION TIME

Following a total power loss (while the system is armed) the control will ignore all burglar defined zones for 15 seconds to allow detectors time to stabilize. Entering a value of "1" in this location extends this time to 181 seconds. A "0" will provide 15 seconds. See page 13 for more information.

189 - DISABLE INTERIOR FOLLOWER

The control automatically ignores all interior defined zones upon entry through a delay defined zone. This allows the motion detectors to be placed between the entry delay door and the control station. A value of "1" assigned to this Function disables the interior follower feature allowing all interior defined zones to remain instant during the entrance delay period.

190 - INTERIOR ON/OFF (KEY 4) AVAILABLE WHEN CONTROL IS ARMED

A value of "1" in this location will allow the interior on/off selection through key 4 to be operable even if the system is armed. A value of "0" will allow changes to interior on/off status only when the system is disarmed. Turning the interior on/off may also toggle the entrance delay on/off, depending upon programming of Function 191.

191 - ENTRANCE DELAY OFF WHEN INTERIOR OFF

A value of "1" in this location instructs the control to disable the entrance delay whenever the interior defined zones are turned off. A value of "0" disables this feature, leaving the entrance delay intact. The Interior may be turned off manually by pressing and holding key 4. The Interior may be automatically turned off after the expiration of the exit delay if no delay zones are violated by enabling Function 187.

192 - SIREN /BELL TEST UPON ARMING

A value of "1" in this location enables a one second test of the Burglar alarm whenever the control is armed. The Assignable Output (terminal 3) must also be programmed to activate upon a Burglar alarm condition as set by Function 256 and 257 unless output is being achieved through the optional Z729 Siren Driver/Output Expander. The communicator will not report this alarm.

193 - RESET TEST TIMER AFTER SUCCESSFUL REPORT

A value of "1" in this location causes the automatic test timer to reset after receiving a valid kiss-off signal from the central station receiver. The automatic test will occur 24 hrs after the last successful transmission or as set in Function 20.

194 - INTERIOR DEFAULT UPON DISARM

A value of "1" in this location instructs the control to turn the interior off each time the control is disarmed. The entrance delay will also turn off if Function 191 is programmed with a value of "1". **U.L. Note: Shall be programmed to "0" in U.L. Listed Systems.**

195 - DISABLE KEYPAD SHUNTING

A value of "1" in this location disables the ability to manually shunt zones from the control stations.

196 - DISABLE KEYPAD CHANGE OF INTERIOR ON/OFF (KEY 4)

A value of "1" in this location disables the ability to turn the interior on or off from the control stations.

197 - DISABLE KEYPAD CHANGE OF ZONE CHIME ON/OFF (KEY 6)

A value of "1" in this location disables the ability to turn the zone chime on or off from the control stations.

198 - DISABLE KEYPAD SWITCHED POWER INTERRUPT (KEY 7)

A value of "1" in this location disables the ability to reset a low battery condition and interrupt Switched Power from the control stations.

199 - DISABLE KEYPAD PERFORMED ZONE WALK TEST (KEY 8)

A value of "1" in this location disables the ability to perform a zone walk test from the control stations.

200 - SILENT KEYPAD ON BURGLAR ACTIVATION

A value of "1" in this location instructs all control stations to be silent during a burglar alarm activation. **NOTE: If this Function is enabled, a "Fail to Communicate" condition will not annunciate the control station sounder. U.L. Note: U.L. Listed Systems shall have an audible alarm output upon alarm.**

201 - DISABLE CONTROL STATION AUDIBLE OR VISUAL INDICATION ON AUXILIARY "B" (POLICE) ACTIVATION

A value of "1" in this location instructs the control stations not to display visual or audible notification of a Auxiliary "B" (police) activation whether activated from the control station zone or a hardwired Auxiliary "B" zone.

202 - START ENTRANCE DELAY 1 UPON KEYPAD ENTRIES

A value of "1" in this location instructs the control to begin entrance delay 1 when a keypad key is pressed while armed. This feature provides additional protection against control station tampering for higher levels of security.

203 - 208 SUPERVISORY/TROUBLE DETECTION ON OPEN OR SHORT? (ZONES 1 - 6)

Any of the 6 hardwire zones may be defined for supervisory/trouble detection by programming of the zone definitions (Functions 41 -46). Functions 203 through 208 define whether a trouble condition will be detected due to a short or open in the corresponding zone. A value of "0" instructs the control to detect trouble from a loop open and a value of "1" from a loop short. Functions 203 through 208 correspond directly to zones 1 thru 6 respectively (Function 203 = zone 1, 204 = zone 2, etc.). **U.L. Note: Fire zones shall be programmed for Supervisory/Trouble on an open circuit condition in U.L. Listed Systems.**

FUNCTIONS 209 TO 247 ARE USED TO SELECT THE EXTENDED REPORTING DIGITS. IF EXTENDED REPORTING OR 4/2 FORMAT IS NOT UTILIZED SKIP TO FUNCTION 248.

The following Functions are for programming extended reporting codes when an extended reporting format has been selected. If extended reporting is not selected, Functions 209 thru 247 may be skipped. If extended reporting is used, code values possible are 1 thru 15. An extended code of 0 is possible by entering a value of 10 (0 represents the tenth digit). Some receivers receive values of 10 thru 15 as hexadecimal codes A, B, C, D, E, & F.

209-214 - USER AUTHORIZATION CODE 1-6 EXTENDED REPORTING CODES

The value in each location represents the extended code which will identify the corresponding user authorization code used to either arm/disarm, shunt, or cancel an alarm when any of those conditions are programmed to report to the central station receiver.

215 - KEYSWITCH ZONE EXTENDED CODE

The value in this location represents the extended code transmitted whenever the control is armed/disarmed using a key switch zone.

216-221 - ZONE 1-6 EXTENDED ALARM REPORTING CODES

The value in each location represents the extended code which will identify the corresponding hardwire zone when an alarm report is transmitted to the central station receiver.

222-227 - ZONE 1-6 EXTENDED RESTORE REPORTING CODES

The value in each location represents the extended code which will identify the corresponding hardwire zone when a zone restore report is transmitted to the central station receiver.

228-233 - ZONE 1-6 EXTENDED SHUNT REPORTING CODES

The value in each location represents the extended code which will identify the corresponding hardwire zone when a shunted zone report is transmitted to the central station receiver.

234-239 - ZONE 1-6 EXTENDED SUPERVISORY/TROUBLE REPORTING CODES

The value in each location represents the extended code which will identify the corresponding hardwire zone when a supervisory/trouble condition is detected and transmitted to the central station receiver.

240 - EXTENDED AC POWER REPORTING CODE

The value in this location represents the extended code reported when an AC power failure or AC power restoral code is transmitted to the central station receiver.

241 - EXTENDED LOW BATTERY/FUSE BLOWN REPORTING CODE

The value in this location represents the extended code reported when a low battery/blown fuse or battery/fuse restoral code is transmitted to the central station receiver.

242 - EXTENDED MEMORY ERROR REPORTING CODE

Value programmed in this location represents the extended digit reported when an EEPROM memory error condition is transmitted.

243 - EXTENDED TEST REPORTING CODE

Value programmed in this location represents the extended code reported when a communicator test is conducted or upon initial power-up (see Function 55).

244 - EXTENDED KEYPAD PANIC ZONE "A" REPORTING CODE

Value programmed in this location represents the extended code reported when a keypad panic zone "A" alarm is transmitted.

245 - EXTENDED KEYPAD PANIC ZONE "B" REPORTING CODE

Value programmed in this location represents the extended code reported when a keypad panic zone "B" alarm is transmitted.

246 - EXTENDED KEYPAD PANIC ZONE "C" REPORTING CODE

Value programmed in this location represents the extended code reported when a keypad panic zone "C" alarm is transmitted.

247 - EXTENDED MISSING KEYPAD REPORT

Value programmed in this location represents the extended code reported when a missing keypad is detected. This code is used as an identification digit only and will not report unless supervisory/trouble conditions are being reported to the central station receiver.

A missing keypad activates the control station "Trouble" (supervisory/trouble) LED (see "Control Station Power-up and Supervision", page 14).

248 - ELIMINATE BURGLAR ZONE EOLR SUPERVISION

A value of "1" programmed in this location will eliminate the need for end-of-line resistors on all burglar defined hardwired zones. The zones will then be unsupervised closed circuit loops.

249 - RESERVED FOR FUTURE USE - EXITS TO PROGRAMMING MODE (SEE FUNCTION 21)

250 - RESTORE USER CODE 1 DEFAULT VALUE

Entering this location will restore the Master User Authorization Code to its default value (1245). No values may be entered in this location. Because the Master User Authorization Code is required in order to program User Authorization Codes 2-6, this Function will permit the Master Code to be returned to default without having to default the entire memory contents.

251 - "FAST" LOOP RESPONSE TIME 1

Time in milliseconds that a loop violation must be maintained before a fault will be recognized on any hardwired zone defined as "Fast Response". A value of 0=80ms, 1=40ms, 2=80ms, 3=120ms, 4=160ms, 5=200ms, 6=320ms, 7=480ms, 8=600ms, 9=800ms, 10=1 sec, 11=2 sec, 12=4 sec, 13=6 sec, 14=8 sec, 15=10 sec.

NOTE: 80 milliseconds should be the minimum time programmed and U.L. requires that loop response not exceed one second (a value of 10).

252 - "SLOW" LOOP RESPONSE TIME 2

Time in milliseconds that a loop violation must be maintained before a fault will be recognized on any hardwired zone defined as "Slow Response". Program in the same manner as Function 251.

253 - RESERVED FOR FUTURE USE - EXITS TO PROGRAMMING MODE (SEE FUNCTION 21)

254 - RESTORE FACTORY DEFAULTS (NEW EEPROM VALUES)

Factory default EEPROM values may be restored by first entering a "1" in this location, and then exiting the program mode. After exiting, the control will restore all factory defaults after approximately 5 seconds. Function 250 allows the Master User Authorization Code to be defaulted by itself without having to default the entire control.

NOTE: This function replaces all installer and user level programming values returning the control to factory default values as shipped and disables all central station communication.

255 - INSTALLER PROGRAM AUTHORIZATION CODE

The installer program authorization code is used to gain entry into the installer level programming mode. This code MUST be 5 digits in length. The code at default is 96321.

256 - ASSIGNABLE OUTPUT DEFINITION

This Function determines the type of condition that will activate the +12VDC Assignable Output (terminal 3). Select the desired condition from the table below and enter into Function 256. If Function 256 is programmed for output upon Alarm conditions (value of "0"), one or more of Functions 257-260 must be programmed with a value of "1" to determine the type of alarm condition(s) desired.

Value Programmed (Function 256)	+12VDC Output from Terminal 3 upon:	U.L. Note: Auxiliary "C" (Emergency) shall be silent in U.L. Listed Systems.	
0	Alarm Condition(s) as determined by Functions 257-260	Value of "1" Programmed In Function:	The Following "Alarm Conditions" Provide +12VDC Output:
1	Sw. Power reset (Key 7)/Auto Tests	257	Burglary
2	Activation of Access	258	Auxiliary "A" (Fire ff)
3	Supervisory/Trouble Conditions	259	Auxiliary "B" (Police)
4	Entrance pre-alarms and Chime	260	Auxiliary "C" (Emergency)

TABLE 8 ASSIGNABLE OUTPUT (terminal 3) DEFINITION

NOTE: Refer to Section 5 for U.L. Listed System requirements

257 - BURGLAR ALARM ACTIVATES ASSIGNABLE OUTPUT (terminal 3)

A value of "1" instructs the control to provide +12VDC from Assignable Output (terminal 3) whenever a Burglar alarm activates. A value of "0" disables this feature. Function 256 must also be programmed with a value of "0" to enable the terminal 3 to respond to Alarm conditions. **U.L. Note: Shall be programmed as "1" in U.L. Listed Systems.**

258 - AUXILIARY "A" (FIRE ff) ACTIVATES ASSIGNABLE OUTPUT (terminal 3)

A value of "1" instructs the control to provide +12VDC from the Assignable Output (terminal 3) whenever an Auxiliary "A" alarm activates. A value of "0" disables this feature. Function 256 must also be programmed with a value of "0" to enable the terminal 3 to respond to Alarm conditions.

259 - AUXILIARY "B" (POLICE) ACTIVATES ASSIGNABLE OUTPUT (terminal 3)

A value of "1" instructs the control to provide +12VDC from the Assignable Output (terminal 3) whenever an Auxiliary "B" alarm activates. A value of "0" disables this feature. Function 256 must also be programmed with a value of "0" to enable the terminal 3 to respond to Alarm conditions.

260 - AUXILIARY "C" (EMERGENCY) ACTIVATES ASSIGNABLE OUTPUT (terminal 3)

A value of "1" instructs the control to provide +12VDC from the Assignable Output (terminal 3) whenever an Auxiliary "C" alarm activates. A value of "0" disables this feature. Function 256 must also be programmed with a value of "0" to enable the terminal 3 to respond to Alarm conditions. **U.L. Note: This Function shall be disabled in U.L. Listed Systems.**

261 - DISABLE KEYPAD PANIC ZONE "A" (FIRE ff)

A value of "1" disables the keypad activated panic zone "A" (FIRE ff) from operation. Default is "0" (enabled).

262 - DISABLE KEYPAD PANIC ZONE "B" (POLICE)

A value of "1" disables the keypad activated panic zone "B" (POLICE) from operation. Default is "0" (enabled).

263 - DISABLE KEYPAD PANIC ZONE "C" (EMERGENCY)

A value of "1" disables the keypad activated panic zone "C" (EMERGENCY) from operation. Default is "0" (enabled).

264 - RESERVED FOR FUTURE USE - EXIT TO PROGRAMMING ENTRY MODE (SEE FUNCTION 21)

265 - TONE TEST GENERATION FACTORY USE ONLY. NO VALUES MAY BE PROGRAMMED INTO THIS LOCATION.

266 - FACTORY ID FACTORY USE ONLY. NO VALUES MAY BE PROGRAMMED INTO THIS LOCATION.

267 - TELEPHONE NUMBER 1 UPLOAD/DOWNLOAD COMPLETED REPORTING CODE

The reporting code which may be sent to the central station immediately after an upload/download session is completed.

268 - TELEPHONE NUMBER 2 UPLOAD/DOWNLOAD COMPLETED REPORTING CODE (Program in same manner as 267).

269 - EXTENDED UPLOAD/DOWNLOAD COMPLETED REPORTING CODE

The extended reporting code which may be sent to the central station immediately after an upload/download session is completed.

270 - PULSE DIALING 66/33 MAKE BREAK RATIO

When the communicator is transmitting in the rotary (pulse) mode, contact closure to the telephone line is made in a 60/40 ratio. A value of "1" in this location instructs the communicator to make contact 66% of the time and break contact 33% of the time. This 66/33 ratio is necessary in some foreign countries. **KEEP THIS FUNCTION PROGRAMMED TO A VALUE OF "0" IN ALL U.S. AND NORTH AMERICAN INSTALLATIONS.**

271 - KEYPAD PANIC 3 SECOND (HOLD OR PRESS TWICE) MODE

Each keypad panic zone is activated by momentarily pressing its designated emergency key. A value of "1" will instruct the control to ignore momentary emergency key presses and require the keypress to be maintained for three seconds (or to be pressed at least twice within three seconds). Default = "1" (3 second mode).

Specifications



TECHNICAL SPECIFICATIONS

Z900 Control Board:

- Six (6) two wire zones each supervised with a 2,200 ohm end-of line resistor.
- Three keypad activated zones.
- Nominal current drain for control board only: 42 milliamps.
- Watchdog microprocessor monitoring circuit.
- Superior 4 stage lightning/transient protection.
- One assignable high current alarm output.
- Low voltage detection monitoring @ 11.2 Volts threshold.
- Automatic system shutdown if voltage falls below 7.5 volts.
- Operating temperature range inside the enclosure: 32°F to 122°F (0°C to +50°C).

Power Supply:

- Full 1.5 Amp regulated.
- Less than 200 millivolts AC ripple.
- Regulated 13.8 Volts DC 900 milliamps continuous output. (See Table 10 for U.L. and C.S.F.M. limits).
- Reverse polarity protection on battery inputs.
- Float charging circuit: 13.8 Volts DC.
- Fused outputs for: Auxiliary 2 power and Assignable Output (5mm x 20mm standard acting 2.5A); Keypad/Auxiliary 1 power and Switched power (5mm x 20mm standard acting 2.5A).

Recommended Battery:

- Rechargeable 12 Volt 4 Amp-hour (B1240) or 12 Volt 6 Amp-hour (B1260) sealed lead acid.

Transformer (T1635):

- U.L. listed class II plug-in, 16.5 volt AC, 35 VA secondary, 120 volt 60 Hz primary.

Enclosure:

- Twenty (20) gauge metal cabinet with knockout for optional cam lock. Dimensions: 9" W x 10" H x 2.875" D (228.6mm x 254mm x 73.02mm)

Digital Communicator:

- Touchtone® or Rotary (pulse) dialing. Rotary speed: 10pps,(selectable 60% break, 40% make or 66% break, 33% make).
- FCC Registration number: DLH66Y-12286-AL-E. Ringer equivalence: 0.0B.
- Transmission formats include: Slow (10 or 15 baud), fast (20 or 40 baud), Radionics superfast (30 baud) and BFSK®.
- Reports to most major central station receivers.
- Primary and secondary phone numbers up to 16 digits.
- Dual reporting capability.

Control Station (Z900R):

- Color coded four (4) wire hookup.
- Twelve button keypad with audible and tactile feedback.
- Three emergency panic zone keys.
- Mounts to any standard single or double gang electrical box.
- Ten (10) LEDs provide total system and zone status.
- Built-in piezo sounder.
- Nominal current drain: 20 mA all LEDs off, 60mA all LEDs and piezo sounder on.
- Up to 7 per system. (See Table 4-1 for U.L. and C.S.F.M. limits).
- Size: 4.55" H x 6.80" W x .90" D (115.57mm x 172.72mm x 22.86mm)
- Color: Bone white with gray labeling.

Listings and Approvals:

The Z900 Security Control and Z900R Control Station are listed by Underwriters Laboratories As Follows:

APPLICATION	LISTING
Household Burglary	U.L. 1023
Household Fire	U.L. 985
Household Burglary/ Household Fire Combination	U.L.1023/U.L.985

- ** California State Fire Marshal(CSFM) approval pending.
- ** Canadian Department of Communications pending.

Z900 FEATURES

- Ready to install with a factory basic program.
- Programmable from Z900R and Z700R control stations.
- Upload/Download programming and control from a remote location using an IBM PC ® or compatible, a Hayes ® modem, and TRANSPORT-PC software.
- Six (6) User Authorization codes.
- Programmable communicator lockout of burglar defined zones to limit runaway reporting.
- EEPROM memory retains arm/disarm status, alarm memory, and programming after total power loss.
- Self-diagnostics with memory error detection and reporting.
- Six (6) hardwire zones programmable as burglar, 24 hr Auxiliary "A" (fire ff), Auxiliary "B" (police), Auxiliary "C" (emergency), and communicator report only.
- Three keypad activated panic zones.
- A single zone may be programmed for keyswitch arm/disarm.
- Burglar zones may be defined as instant or delay (2 delay timers), interior or perimeter, silent instant, priority (non-shuntable), slow or fast loop response.
- All hardwire zones may be programmed for supervisory/trouble condition latching or momentary.
- Individual or group zone shunt (bypass) from touchpad.
- Zone force arm with full shunt, or restore when zone restores.
- Zone auto shunt or auto restore after alarm.
- 24 hour zones may be programmed as shuntable.
- Programmable Timers: Entry Delay 1 and 2, Exit Delay, Access, Alarm Cut-off, and Delay before audible burglar alarm output.
- Programmable loop response of 40 msec. to 10 seconds.
- Eight (8) second invalid or inactive control station timeout and 3 minute programming timeout.
- Continuous monitoring of control panel fuses.
- Optional siren/bell test upon arming.
- Optional timed or latched access (door strike) output.
- Missing control station detection with communicator report.
- Digital Communicator Reporting Capabilities:
 - 3 or 4 digit account codes.
 - 1 or 2 digit alarm codes.
 - Report by zone.
 - Single or 2 line extended.
 - Two separate Account codes.
 - Hexadecimal reporting.
 - Dual reporting.
 - Split reporting.
 - Opening or Closings by User Code.
 - Shunted zone(s) reported upon arming.
 - Exception openings by User Code.
 - Individual zone and or system restore.
 - Cancel/Abort report by User code.
 - Supervisory/trouble by zone.
 - Low battery and battery restoral.
 - AC failure and AC restoral.
 - Automatic test every 12 hours or 1 to 7 days.
 - Delay before dial.
 - Dial attempts for telephone number one and two.
 - Optional fail-to-communicate annunciation.
 - One (1) minute listen-in on Telephone number 1 or 2.

OPTIONAL ACCESSORIES

- TRANSPORT-PC:** Upload/Download software package.
- MPI-230 Chip Duplicator:** Low cost handheld duplicator for copying a program from one control to another.
- Z729 Siren Driver/Output Expander ††:** Plugs directly into the control board to provide a two channel high power siren driver and separate 40 mA trigger outputs for Burglar, Aux. "A", Aux. "B", Aux. "C", Armed, Ready, Violation, Pre-alarm, Lamp, Access and additional taps for Auxiliary 1 power and common negative termination (Same outputs as Z1100 family connector J16).
- Z229A Output Expansion Module ††:** Expands control to provide additional outputs.
- Z232 Relay/Ground Start Module ††:** For use with phone lines that require a momentary ground to obtain dial tone.
- Z233 Answer Command Module:** Allows Upload/Download Auto Answer mode to operate on telephone lines which have an answering machine attached.
- MPI-266 Low Battery Cutoff Module ††:** Automatically disconnects battery to prevent deep discharge if battery voltage drops below 7.5 volts.

Z700, Z900 and TRANSPORT-PC are trademarks of Aritech Corp.

IBM ® is a registered trademark of International Business Machines, Inc.

Hayes ® is a registered trademark of Hayes Microcomputer Products, Inc.

Touchtone ® is a registered trademark of American Telephone & Telegraph, Inc.

BFSK ® is a registered trademark of Radionics, Inc.

- Made in USA.

†† Not a U.L. Listed device.

COMMUNICATOR LISTEN-IN INPUT -
 Port for injecting the audio from a listen-in microphone, amplifier and line filter onto the telephone line when audio listen-in is being used. A listen-in output trigger is available when a Z229A module is used.

GROUND START - Provides a low current output from +12V to ground (0 volts) when the pulse dial relay is active. The Z232 Ground Start Module trigger connects to this point.

CONNECTOR J15 - Jack for plugging in the optional MPI-230 Chip Duplicator, Z229A Output Expansion Module, or Z729 Siren Driver/Output Expander.

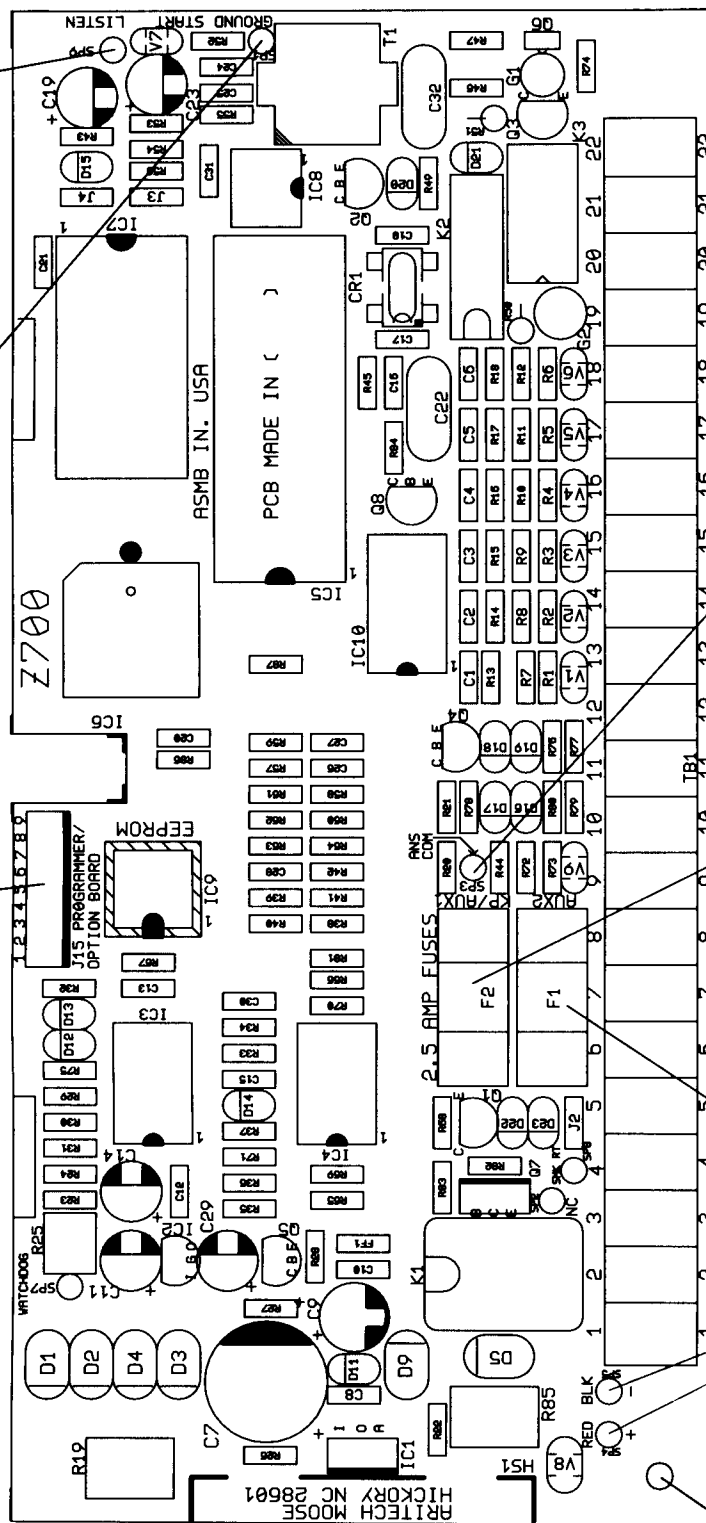

ACM - Input for an optional Z233 Answer Command Module which allows the Upload/Download feature to work on a phone line which has an answering machine attached.

FUSE F2 - 2.5Amp 5mm x 20mm standard acting fuse which protects KeyPad Power/Aux.1 output (terminal 7) and Switched Power (terminal 4).

FUSE F1 - 2.5Amp 5mm x 20mm standard acting fuse which protects Aux.2 output (terminal 5) and the Assignable Output (terminal 3).

BATTERY LEADS -
 Red (+) and black (-) leads for standby battery connection.

GROUND
 Connect enclosure door ground jumper and bonded earth ground to control board screw (See page 3).

FIGURE 17 CONTROL BOARD COMPONENT LAYOUT

NOTE: Refer to Section 5 for U.L. Listed System requirements

Application	Listing	Maximum Current drain (milliamps) with a 4 Ah Battery	Min. Battery Standby Time in hours	Z900R/Z700R Control Stations	E.S.L. Smoke Detector Model 445AT Pyrotector Power Supervision Module Model 20-40-12	Auxiliary Equipment Required
Non U.L. Listed C.S.F.M. Approved		900 750	3 4	7 6	N/A Required	Wheelock 34T-12 Horn
Household Burglary	U.L. 1023	750	4	6	N/A	Amseco MSB-10G Bell
Household Fire (<i>ff</i>)	U.L. 985	750	4	6	Required	Wheelock 34T-12 Horn
Household Burglary/ Fire (<i>ff</i>) Combination	U.L. 1023/ U.L. 985	750	4	6	Required	Amseco MSB-10G Bell and Wheelock 34T-12 Horn
<p>Maximum combined continuous current drain (standby) refers to terminals 3, 4, 5, 7, and Connector J15. Under Alarm conditions, the combined output current drain should not exceed 1.5 Amps.</p>						

TABLE 10 CONFIGURATIONS AND CURRENT DRAIN PROVISIONS

U.L. and N.F.P.A. Requirements



UNDERWRITERS LABORATORIES (U.L.) LISTING

The Z900 Security Control and Z900R and Z700R Control Stations are Listed by Underwriters Laboratories (U.L.) as follows:

APPLICATION	LISTING
HOUSEHOLD BURGLARY	U.L. 1023
HOUSEHOLD FIRE	U.L. 985
HOUSEHOLD BURGLARY/FIRE COMBINATION	U.L. 1023/U.L.985

U.L. has established certain requirements which pertain to the installation, use, and programming of this equipment. The local Authority Having Jurisdiction (AHJ) and/or U.L. may have other requirements which apply to the installation of this system that are not detailed in this manual. It is the responsibility of the installing dealer to check with the AHJ and/or U.L. before installing this system. The following pages detail guidelines that must be followed in order to comply with the U.L. listings as stated above.

DISALLOWED PARTS

The following are parts which are referenced on pages of this manual which are **NOT U.L. LISTED AND SHALL NOT BE USED IN U.L. LISTED SYSTEMS:**

Part No.	Description	Referenced on Pages
MPI-206SP	Relay Board	11
MPI-266	Low Battery Cutoff Module	6, 40
Z229A	Output Expansion Module	11, 40
Z232	Relay/Ground Start Module	40
Z729	Siren Driver/Output Expander	11, 23, 40

COMPATIBLE CENTRAL STATION RECEIVERS

U.L. permits communication with the following U.L. Listed central station receivers:

Manufacturer	Model
Ademco	685
Fire Burglary Instruments	CP-220
Osborne-Hoffman	Quick Alert
Radionics	6000
Radionics	6500
Silent Knight	8000
Sescoa	3000C
Sescoa	3000R

U.L. NOTES TO PAGES IN THIS MANUAL

Page	Reference	U.L. Note
7	Figure 8	In U.L. Listed Systems, burglar alarm zones shall be programmed as end of line supervised so as an alarm is provided for both loop open and loop short conditions.
8	Key Switch Zone	Cannot be used in U.L. Listed Systems.
17	Key Number "0"	The control has not been investigated to U.L. 294 Access Control System Requirements.
23	Auto Answer/ Callback Method	This feature is not enabled in U.L. Listed Systems.
24	Z729 Siren Driver/ Output Expander	This device is not to be used in U.L. Listed Systems.

U.L. NOTES TO PAGES IN THIS MANUAL (Continued):

Page	Reference	U.L. Note
24	Shuntable 24 Hour Aux. A,B,C, Zones	Fire zones are programmed as nonshuntable in U.L. Listed Systems.
24	Group Shunting	Shall not be utilized in U.L. Listed Systems.

□ U.L. NOTES PER PROGRAM FUNCTIONS (Pages 25-38 and A-C)

Number	Function	U.L. Listed System Requirements
11/12	Entrance Delay Time (1 & 2)	Maximum of 45 seconds.
13	Exit Delay Time	Maximum of 60 seconds.
15	Delay Burglar Alarm Output	Shall be programmed for "0" minutes.
16	Burglar Alarm Cutoff Time	4 minutes minimum for household and maximum of 15 minutes.
17	Auxiliary "A" (FIREff) Cutoff Time	No automatic cutoff permitted.
18	Auxiliary "B" (POLICE) Cutoff Time	4 minutes maximum.
20	Time Between Comm. Tests	Commercial Installations: automatic test performed every 24 hours.
47	Communicator Disable/Delay	Local or Police Station Connected burglar alarm installations: The communicator must be enabled.
48/49	Dial Attempts Before Shutdown	5 dial attempts minimum, 10 dial attempts maximum. An even number (2, 4, etc.) shall be selected to enable the Fail to Communicate.
53	Time Between Dial Attempts	U.L. Certified Accounts: No more than 45 seconds between attempts.
56	Exception Opening/System Restore	Shall be programmed as "0".
106/159	Audio Listen-in Capability	This Function shall be disabled.
161-176	Callback Telephone Number	This Function shall be disabled by programming a value of "15".
177	Two Digit Arming	This Function shall be disabled.
178	Enable Force Arming	This Function shall be disabled.
179	Temporary/Perm. Force Arming	This Function shall be disabled.
182	Pulsing Burglar Alarm Output	Shall be programmed to "1" (pulsing).
183	Pulsing Fire Alarm Output	Shall be programmed to "0" (steady).
184	Burglar Loop Audible Lockout	This Function shall be disabled.
194	Interior Default Upon Disarm	Shall be programmed to "1" (enabled).
200	Silent Keypad on BA Activation	The system shall have an audible alarm output upon alarm.
203-208	Supervisory/Trouble Detection on Open or Short? (Zones 1-6)	Fire zones shall be programmed for Supervisory/Trouble on an open circuit condition.
256	Assignable Output Definition	Shall be programmed to "0". Auxiliary "C" (EMERGENCY) shall be silent.
257	BA Activates Assignable Output	Shall be programmed to "1" (enabled).
260	Auxiliary "C" (EMERGENCY) Activates Assignable Output	This Function shall be disabled.

□ U.L. NOTES PER ZONE PLANNING GUIDE (Page D)

Reference	U.L. Listed System Requirements
Burglar Loops	Shall not be defined as Supervisory/Trouble.
Auxiliary "A", "B", and "C" Zones	Shall not be defined as shuntable.
Keyswitch Zone	Shall not be employed.
Special Functions-Alarms	Burglar loops shall be defined as audible.

NATIONAL FIRE PROTECTION ASSOCIATION (NFPA) RULES

The National Fire and Burglar Alarm Association (NFPA) has established rules to follow pertaining to fire prevention and the installation of fire detection equipment.

FIRE PROTECTION

SMOKE DETECTOR LOCATION

Smoke detectors should be installed in accordance with the National Fire Protection Association (NFPA) Standard 74. Figure 18 illustrates detector placement.

The following is from NFPA 74: Smoke detectors shall be installed outside of each separate sleeping area in the immediate vicinity of the bedrooms and on each additional story of the family living unit including basement and excluding crawl spaces and unfinished attics (see Figure 18). For family living units with one or more split levels (i.e., adjacent levels with less than one full story separation between levels), a smoke detector required by the above shall suffice for an adjacent lower level, including basements.

EXCEPTION: Where there is an intervening door between one level and the adjacent lower level, a smoke detector shall be installed on the lower level.

Ceiling mounted smoke alarms should be located in the center of the room or hall, not less than 4 inches from any wall. When the detector is mounted on a wall, the top of the detector should be 4 to 12 inches from the ceiling.

Do not install smoke alarms where normal ambient temperatures are above 100°F (37.8°C) or below 40°F (4°C).

Also, do not locate smoke detectors in front of air conditioners, heating registers, or other locations where normal air circulation will keep smoke from entering the detector.

Heat from a fire rises to the ceiling, spreads out across the ceiling surface and begins to bank down from the ceiling. The corner where the ceiling and wall meet is an air space into which heat has difficulty in penetrating. In most fires, this 'dead' air space measures about 4 inches (0.1m) along the ceiling from the corner and 4 inches (0.1m) down the wall as shown in Figure 18. Heat or smoke detectors should not be placed in this 'dead' air space.

FIRE PREVENTION AND ESCAPE

The purpose of heat and smoke detectors is to detect a fire in its earliest stages and sound an alarm, giving occupants more time to exit the premises before smoke reaches a dangerous level.

KNOW FIRE HAZARDS

No detection device can protect life in all situations; therefore, safeguards should be taken to avoid such potentially dangerous situations as smoking in bed, leaving children home alone, and cleaning with flammable liquids such as gasoline.

The best fire protection is minimizing fire hazards through proper storage of materials and good housekeeping practices. Careless use of combustible materials and electrical appliances or overloading of electrical outlets are major causes of fire. Explosive and fast burning materials must be eliminated from the home.

IN CASE OF FIRE

Leave immediately! Do not stop to pack or search for valuables. In heavy smoke, hold your breath and stay low — crawl if necessary. The clearest air usually is at the floor. If you have to go through a closed door, carefully feel the door and door knob to see if undue heat is present. If relatively cool, brace your foot against the bottom of the door with your hip against the middle, and one hand against the top edge. Open slightly. If there is a rush of hot air, slam the door quickly and latch it. Unvented fire will build up considerable pressure. Be sure that all the household realizes this danger.

Use your neighbors phone or street fire alarm box. The job of extinguishing the fire should be left to the professionals. Too many unforeseen things can occur when inexperienced people try to extinguish a fire.

BE PREPARED

Perform fire drills regularly. Use them to assure recognition of an alarm signal. For your protection, simulate different circumstances (smoke the hall, living room, etc.). Then have everyone react to the situation. Draw a floor plan and show two exits from each room.

It is important that children be instructed carefully. Their tendency is to hide in a crisis.

It is imperative that one meeting place outside the home be established. You should insist that everyone meet there during an alarm. This will eliminate the tragedy of someone re-entering the house for a missing member who is actually safe.

If you have small children and/or invalids residing in your household, you can help your fire department by placing decals on bedroom windows. Most fire departments supply the decals.

Become familiar with the distinctive sounds of your Fire alarm and Burglar alarm signals.

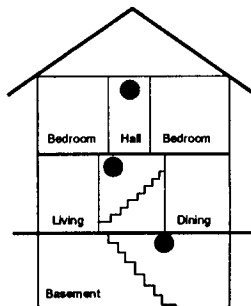
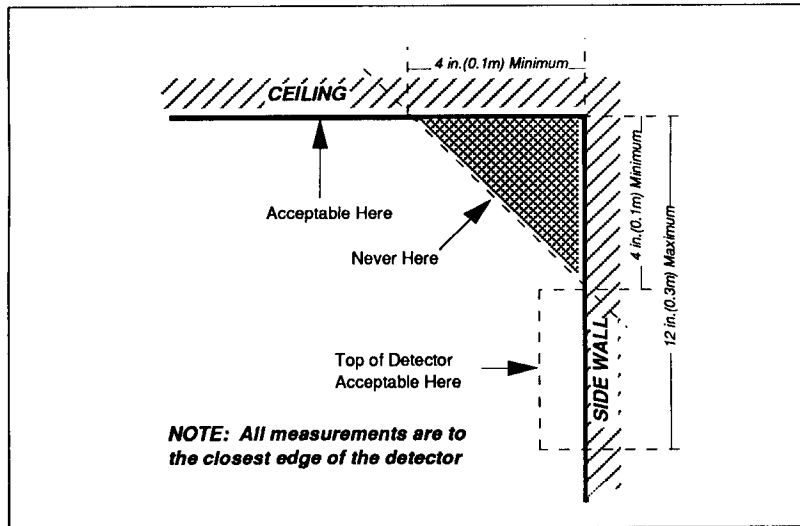

A Smoke Detector should be located on each story.

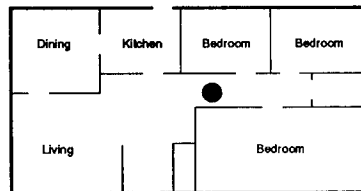

A Smoke Detector should be located between the sleeping area and the rest of the family living unit.

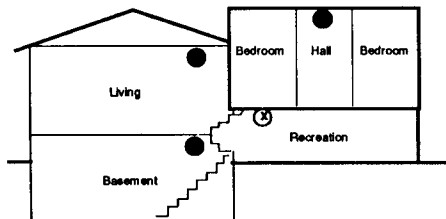

● Indicates required smoke detector

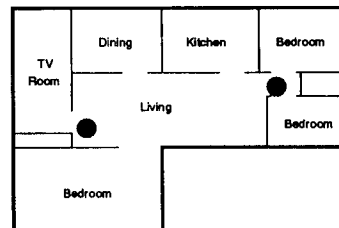

⊗ Indicates smoke detector is optional if door is not provided between living and recreational rooms.

FIGURE 18 SMOKE DETECTOR PLACEMENT

A

AC failure 6, 13, 16
 AC transformer 4, 5, 6, 39
 ACM 41
 Access 17, 27
 Alarm, resetting see “Resetting alarms”
 Alarm LED 14, 15, 16
 Alarm memory 17, 18
 Answer Command Module (Z233) 41
 Answering machines 23
 Arming/disarming 14
 Assignable Output 4, 5, 10, 11, 15
 Audio listen-in 41
 Auxiliary alarms, resetting 14, 15
 Auxiliary Power 1 see “Keypad/Auxiliary Power 1”
 Auxiliary Power 2 4, 5, 10
 Auxiliary zones see “Twenty-four hour Auxiliary zones”

B

Battery see “Standby battery”
 Bell 4
 Burglar alarms, resetting 14
 Bypassing see “Shunting”

C

Cam lock 2
 Chime 16, 17
 Chip Duplicator (MPI-230) 19
 Class “B” end-of-line resistor supervised zones 6, 7
 Closed circuit loop 7
 Communicator
 general 24
 failure to communicate 16, 27
 report only zones 8
 reporting capabilities 40
 specifications 39
 transmission formats 29
 Computer see “Remote Programming”
 Conduit 3
 Configuration digit 27
 Connector J15 11, 41, 42
 Control board 2, 39
 Control board component layout 41
 Control station
 data in/out 4, 5, 8, 10
 hardware pack 2

Control station (continued)

 LEDs 15
 mounting 9
 operation 15
 parts list 2
 power-up 14
 specifications 39
 supervision 14
 troubleshooting 9
 wiring 8
 zones 11
 zone operation 15
 CSFM approval 42
 Current drain (limitations) 10, 42

D

Default

 program 19
 restoring 22
 Delay on/off 16
 Diagnostic features 16
 Diagnostic Overlay 16, 18
 Digital communicator see “Communicator”
 Disarming see “Arming/disarming”
 Duress 27

E

Earth ground 3, 4, 41
 EEPROM inside front cover, 13
 Emergency panic zones 11, 15
 Enclosure 2, 39
 End-of-line resistor 6
 Exit delay beep (silencing) 23

F

Fail to communicate see “Communicator”
 Find key 20
 Fire inside front cover, 14
 Float battery voltage 4
 Force arming 23
 Function
 definition 19
 descriptions 25-38
 map (description) 21
 reading value 20

Fuses (F1/F2) 9, 41
 Fuses (F1/F2) continued
 see also "Low Battery/Blown Fuse"

G

Ground see "Earth ground"
 Ground start 41
 Ground wire lug 3

H

Hardwire zones 6, 7, 8
 High Security Arm/Disarm Code 14, 24, 27

I

Installer Program Authorization Code 19
 Interior on/off 16, 17

J

J15 see "Connector J15"

K

Key switch zone 8
 Keypad/Auxiliary Power 1 4, 5, 10
 Knockouts, enclosure 2, 3

L

Layout, Typical Installation 1
 Lightning/transient protection 3, 4
 Line seizure see "Telephone"
 Limitations inside front cover
 Listen-in see "Audio Listen-in"
 Low battery/Blown fuse 16
 Low Battery Cut-off Module (MPI-266) 6

M

Master User Authorization Code 14, 19, 25
 Memory error 16
 Missing keypad 16
 Monitor see "Chime"
 Mounting the enclosure 3
 MPI-206SP see "Relay Module" (MPI-206SP)

MPI-230 see "Chip Duplicator"
 MPI-266 see "Low Battery Cut-off Module"

N

Negative termination 5
 Next key 20
 Non-shuntable zones see "Priority Zones"
 Non-supervised closed circuit loop .. see "Closed circuit loop"

O

Operating temperature range 3, 39
 Optional accessories 40
 Outputs see specific type of output desired
 Output Expansion Module (Z229A) 11, 41

P

Panic keys 11, 15
 Planning 1
 Power failure (AC/DC) 13
 Power supply 39
 Power-up (control) 13
 Priority Zones 24
 Program (key 9) 17
 Program mode, exiting 21
 Program Functions see "Functions"
 Programming
 default (restoring) 21
 installer level 19-21
 remote 23
 special features 23
 timer 19
 user level 22

R

Ready LED 15
 Relay Module (MPI-206SP) 11
 Remote programming 23
 Reset 17
 Resetting alarms 14, 15
 ROM 13

S

Seizure see "Telephone"
 Shuntable zones 24
 Shunting 15, 17

Siren driver	
Z729 Siren Driver/Output Expander	11, 15, 23, 41
wiring	10
Smoke detector	
resetting	5, 10
wiring	4, 10
Specifications	39
Standby battery	
general	4, 6
float battery voltage/maximum current	4
quiescent charge current	4
recommended	39
replacement	4
Step voltage blowout	3
Store key	20
Supervisory/trouble	6, 16, 24
Switched Power	4, 5, 10
Switched power interrupt	17
T	
Telephone	
general	12
cord (TC-3 direct connect cord)	4
FCC compliance	4, inside rear cover
FCC registration number/ringer equivalence	12, 39
hook-up	4, 5, 12
line seizure	12, 24
line supervision	4
RJ-31X/RJ-38/X jack	4, 12
testing	12
Temperature range	see "Operating temperature range"
Test	17
Timer (8 second programming)	19
Transformer	see "AC transformer"
Transients	see "Lightning/transient protection"
Trouble key	16, 17
Trouble LED	13, 15, 16, 17
Twenty-four hour Auxiliary zones	8
Twenty-four hour communicator report only zones	8
W	
Watchdog Monitor	inside front cover, 13
Z	
Z229A	see "Output Expansion Module"
Z729	see "Siren Driver"
Z233	see "Answer Command Module"
Z900R	see "Control Station"
Zone LEDs	14, 15, 15
Zone bypassing	see "Shunting"
Zone definition	27
Zone planning	20
Zone shunting	see "Shunting"
Zone wiring	7

T

Telephone	
general	12
cord (TC-3 direct connect cord)	4
FCC compliance	4, inside rear cover
FCC registration number/ringer equivalence	12, 39
hook-up	4, 5, 12
line seizure	12, 24
line supervision	4
RJ-31X/RJ-38/X jack	4, 12
testing	12
Temperature range	see "Operating temperature range"
Test	17
Timer (8 second programming)	19
Transformer	see "AC transformer"
Transients	see "Lightning/transient protection"
Trouble key	16, 17
Trouble LED	13, 15, 16, 17
Twenty-four hour Auxiliary zones	8
Twenty-four hour communicator report only zones	8

U

U.L.	42
Upload/download	23
Unified earth ground	see "Earth ground"
Usage count	25
User Authorization Code	14, 19, 25
User level programming	14, 19, 22
User operation	14

FCC COMPLIANCE

This equipment generates and uses radio frequency energy and if not installed and used properly, that is, in strict accordance with the manufacturer's instructions, may cause interference to radio and television reception. It has been type tested and found to comply with the limits for a Class B computing device in accordance with the specifications of Subpart J or part 15 of FCC rules, which are designed to provide reasonable protection against such interference in a residential installation. However, there is no guarantee that interference will not occur in a particular installation. If this equipment does cause interference to radio or television reception, which can be determined by turning the equipment off and on, the user is encouraged to try to correct the interference by one or more of the following measures:

1. Reorient the TV or radio antenna.
2. Relocate or move the alarm control away from the receiver.
3. Plug the transformer for the alarm control into a different outlet so that the receiver and the alarm are on different branch circuits.
4. If necessary, the user should consult the alarm dealer or an experienced radio/television technician for additional suggestions.

The user may find the following booklet prepared by the Federal Communications Commission helpful: "How To Identify and Resolve Radio-TV Interference Problems." This booklet is available from the U.S. Government Printing Office, Washington, DC 20402 stock #004-000-00345-4.

This equipment complies with Part 68 of the FCC rules.

ADDITIONAL TELEPHONE COMPANY INFORMATION

The security control panel must be properly connected to the telephone line with a USOC RJ-31X or RJ-38X telephone jack and a matching 8 pin modular "Direct Connect Cord."

The FCC prohibits customer-provided terminal equipment be connected to party lines or to be used in conjunction with coin telephone service. Inter-connect rules may vary from state to state.

INCIDENCE OF HARM

In the unlikely event that the communicator should ever cause harm to the telephone network, the telephone company will notify the telephone subscriber that temporary discontinuance of service may be required; however, where prior notice is not practicable, the telephone company may temporarily discontinue service. In the case of temporary discontinuance, the telephone company shall promptly notify the telephone subscriber who will be given the opportunity to correct the situation. The customer also has the right to bring a complaint to the FCC if he feels the disconnection is not warranted.

If your telephone equipment causes harm to the telephone network, the telephone company may discontinue your service temporarily. If possible, they will notify you in advance, but if advance notification is not practical, you will be notified as soon as possible. You will be notified of your right to file a complaint with the FCC.

CHANGES IN TELEPHONE COMPANY EQUIPMENT OR FACILITIES

The telephone company may make changes in its communications facilities, equipment, operations or procedures, where such action is reasonably required and proper in its business. Should any changes render the communicator incompatible with the telephone company facilities, the customer shall be given adequate notice to make modifications to maintain uninterrupted service.

NOTIFICATION

All connections to the telephone network must be made through standard plugs and standard telephone company jacks, or equivalent, in such a manner as to allow for easy and immediate disconnection of the alarm equipment. If the connecting cord is unplugged from the jack there shall be no interference to the telephone equipment still connected to the telephone network.

Notify the telephone company if the communicator is removed from the premises and the RJ31-X or RJ38-X jack is no longer needed.

MALFUNCTIONS OF EQUIPMENT

In the unlikely event that the system should ever fail to operate properly, it should be disconnected from the RJ31-X or RJ38-X jack to determine if the problem is with the telephone network or with the security system. If a problem is found with the communicator, leave disconnected until repaired or replaced.

If you experience trouble with the telephone equipment, please contact the Aritech Technical Assistance Department at (800)800-2626 and ask for information on obtaining service or repairs. The telephone company may ask that you disconnect this equipment from the network until the problem has been corrected or until you are sure that the equipment is not malfunctioning.