



D2012 Control / Communicator Installation Manual

Notice

The material and instructions covered in this manual have been carefully checked for accuracy and are presumed to be reliable. However, Radionics, Inc. assumes no responsibility for inaccuracies and reserves the right to modify and revise this manual without notice.

If a discrepancy is found in this documentation, please mail a photocopy of the corrected material to:

Technical Communications
c/o Radionics, Inc.
1800 Abbott Street
P.O. Box 80012
Salinas, CA 93912-0012

© 1997 Radionics, Inc. Salinas, CA, U.S.A. All rights reserved.

FCC Notice

Part 15

This equipment has been tested and found to comply with the limits for a Class B digital device, pursuant to Part 15 of the FCC Rules. These limits are designed to provide reasonable protection against harmful interference in a residential installation. This equipment generates, uses, and can radiate radio frequency energy, and, if not installed and used in accordance with the instruction manual, may cause harmful interference to radio communications. However, there is no guarantee that interference will not occur in a particular installation. If this equipment does cause harmful interference to radio or television reception, which can be determined by turning the equipment off and on, the user is encouraged to try to correct the interference by one or more of the following measures:

- Re-orient or relocate the receiving antenna.
- Increase the separation between the equipment and the receiver.
- Connect the equipment into an outlet on a circuit different from that to which the receiver is connected.
- Consult the dealer or an experienced radio/TV technician for help.

Part 68

This equipment complies with Part 68 of FCC rules. A label contains, among other information, the FCC registration number and ringer equivalence number (REN).

Radionics registered the D2012 Control/Communicator for connection to the public telephone network using an RJ31X jack.

Use the ringer equivalence number (REN) to determine the number of devices you can connect to the telephone line. Excessive RENs on the telephone line may result in devices not ringing in response to an incoming call. In most, but not all areas, the sum of the RENs should not exceed five (5). Contact the telephone company to determine the maximum REN for the calling area.

If the D2012 Control/Communicator causes harm to the telephone network, the telephone company will notify you in advance. If advance notice isn't practical, the telephone company will notify the customer as soon as possible. Also, you will be advised of your right to file a complaint with the FCC if you believe it is necessary.

The telephone company may make changes in its facilities, equipment, operations, or procedures that could affect the operation of the D2012. If this happens, the telephone company will provide advance notice in order for you to make the necessary modifications to maintain uninterrupted service.

If you experience trouble with the D2012 Control/Communicator, please contact Radionics Customer Service for repair and/or warranty information. If the trouble is causing harm to the telephone network, the telephone company may request that you remove the D2012 from the network until the problem is resolved. User repairs must not be made. Doing so voids the user's warranty.

Do not install the D2012 on public coin service provided by the telephone company. Connection to Party Line service is subject to state tariffs (contact your state public utilities commission for information). You must supply the local telephone company with the following information at their request:

- The line you are going to connect the panel to.
- Make (Radionics), model (D2012), and serial number of the panel.
- FCC registration number and ringer equivalence for the panel.

FCC Registration Number: ESVUSA-30727-AL-E

Ringer Equivalence: 0.3B

Service Center in USA: Radionics, Inc.
1800 Abbot Street
P.O. Box 80012
Salinas, CA 93912-0012
(800) 538-5807

Notice

The Industry Canada label identifies certified equipment. This certification means that the equipment meets certain telecommunications network protective, operational, and safety requirements. Industry Canada does not guarantee the equipment will operate to the user's satisfaction.

Before installing this equipment, users should ensure that it is permissible to be connected to the facilities of the local telecommunications company. The equipment must also be installed using an acceptable method of connection. The customer should be aware that compliance with the above conditions may not prevent degradation of service in some situations.

Repairs to certified equipment should be made by an authorized Canadian maintenance facility designated by the supplier. Any repairs or alterations made by the user to this equipment, or equipment malfunctions, may give the telecommunications company cause to request the user to disconnect the equipment.

Users should ensure for their own protection that the electrical ground connections of the power utility, telephone lines and internal metallic water pipe system, if present, are connected together.

Caution: Users should not attempt to make such connections themselves, but should contact the appropriate electric inspection authority, or electrician, as appropriate.

Table Of Contents

Introduction	4	Make the Telephone Connections	10
D2012 Control / Communicator	4	Power Up	10
Ordered Separately	4	Program the Panel	10
Enclosure Options	4	Unlock the Standby Switch	10
Listings and Approvals	5	Fill out the Delay Chart	11
		Test the System	11
Getting Started	5	Detailed Description	11
Mount the Enclosure	5	Primary (AC) Power Circuit	11
Run the Premises Wiring	5	Secondary (DC) Power	11
Connect to Earth Ground	6	Power Outputs	12
Transformer	6	Telephone	12
Battery	6	Points	13
		Keyswitch	13
Charge the Battery as You Work	6	Easikey Diagram	14
Lock the Standby Switch	6	Installation Guide for UL Applications	15
		Introduction	15
Install Detection Devices, Keypads, Bells	6	Optional Compatible Equipment	15
No Connection to the Panel Yet	6	System Chart	17
Number of Sensors	6	Current Rating Chart for Standby Battery	
		Calculations	18
Continue Connections to the Panel	7	Standby Battery Requirements	17
Power Down First	7	System Wiring Diagram, Issue A	18
Alarm Output	7	Specifications	19
Keypads	7	D2012 Terminal Quick Reference	20
Auxiliary Power	8		
Checking Continuous Current Draw	8		
External Relays	8		
Connect the Points	8		
Point 1	8		
Points 2 to 6	9		
Point Wiring Diagram	9		

Introduction

D2012 Control / Communicator

The Radionics D2012 Control/Communicator is shipped pre-assembled from the factory. You should receive the following parts with your D2012 panel.

Panel Assembly

- D2012 Panel
- D2803 Enclosure
- D1625 Transformer
- Technogram: Smoke Detectors Compatible with the D2012 (35119)
- Release Notes: Firmware Revision (35118)

Hardware Pack

- One 2k Ω end-of-line resistor for Point 1 (15-03130-010)
- Five 1k Ω end-of-line resistors for Points 2 - 6 (30-01098-102)
- Two #6 by 3/8" sheet metal screws to secure the D2803 Enclosure cover (60-03977-006).
- Plastic Clips: for mounting the panel to the enclosure
- Two #6 by 1/2" thread forming screws: for mounting the panel to the enclosure

Ordered Separately

Literature Pack (L2012-LIT)

- Installation Manual (35122)
- Program Entry Guide (35121)
- Program Record Sheet (35120)
- Keypad Diagnostics Manual (35117)

D202A Keypad

Each D202A includes the following:

- D202A Keypad
- Installation Sheet (74-07118-000)
- User's Cards (71-07090-000)
- Security System User's Guide (71-07117-000)
- Getting Started with Your Security System (71-07372-000)
- Three-wire data cable assembly (15-07032-000)

D205 Keypad

Each D205 includes the following:

- D205 Keypad
- Installation Sheet (31945)
- Security System User's Guide (71-07117-000)
- Getting Started with Your Security System (71-07372-000)
- Three-wire data cable assembly (15-07032-000)

D206 Keypad

Each D206 includes the following:

- D206 Keypad
- Installation Sheet (31946)
- Security System User's Guide (71-07117-000)
- Getting Started with Your Security System (71-07372-000)
- Three-wire data cable assembly (15-07032-000)

D220A Keypad

Each D220A includes the following:

- D220A Keypad
- Installation Sheet (74-07363-000)
- User's Reference Card (71-05432-011)
- Security System User's Guide (71-07374-000)
- Getting Started with Your Security System (71-07372-000)
- Three-wire data cable assembly (15-07032-000)

D223 Keypad

Each D223 includes the following:

- D223 English Keypad
- Installation Sheet (74-07490-000)
- User's Reference Card (71-04523-010)
- Security System User's Guide (71-07373-000)
- Getting Started with Your Security System (71-07372-000)
- Three-wire data cable assembly (15-07032-000)

Battery

Order a **D1240 Battery** (12 V 4.0Ah) to complete a basic D2012 installation.

Order a **D126 Battery** (12 V 7.0Ah) for fire and combined fire/burglary systems.

Enclosure Options

The D2012 is shipped in the D2803 enclosure. If you want to mount the D2012 in one of the optional enclosures listed below, order the D2012M and the enclosure of your choice.

- D8103 Universal Enclosure
- D8108A Attack Resistant Enclosure
- D8109 Fire Rated Enclosure

Listings and Approvals

The D2012 has the following approvals:

Fire

Underwriters Laboratories as a Household Fire and Burglary Warning System Control Unit for NFPA 72 (Chapter 2) Household Fire Warning.

CSFM (Residential)

UL 985 Household Fire Warning Systems

Burglary

UL 1023 Household Burglary Alarm

UL 365 Police Station Connect

UL 609 Local Burglary Alarm

UL 1076 Proprietary Burglary Alarm

UL 1610 Central Station

Getting Started

Review this manual before you begin to determine hardware and wiring requirements for the features you want to use. Have the following handy as you read through the manual:

- Program Record Sheet (35120)
- Program Entry Guide (35121)
- Security System User's Guide

Mount the Enclosure

Open the cover to access the mounting holes in the rear of the enclosure. Note the wiring label on the inside of the enclosure cover.

Mount it in the desired location. Be sure there is enough clearance to open the door for maintenance. Mount the panel into the enclosure as shown in Figure 1, below.

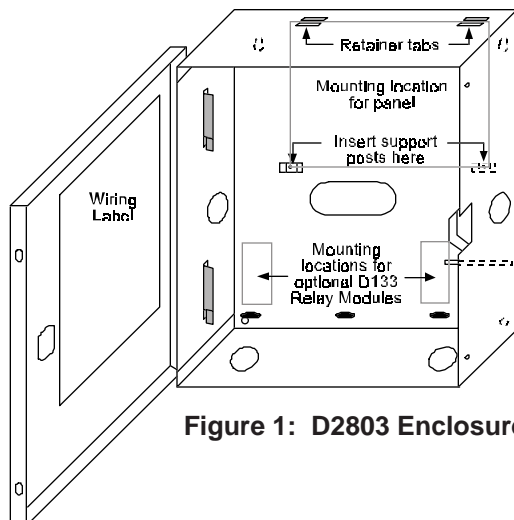

Figure 1: D2803 Enclosure

Insert the two support posts in the retainer holes. Slide the top of the panel into the two retainer tabs. Once in the tabs, the panel will rest on the two support posts. Secure the panel with the supplied screws.

Run the Premises Wiring

Run the necessary wiring throughout the premises and pull the wires into the enclosure. Do not make any connections yet.

Wire Length

Wire Length for points is limited only by the resistance on the loop and potential EMI (Electro Magnetic Interference) problems.

Wire resistance on the Point 1 sensor loop must be less than 50Ω . Measure the wire resistance before installing smoke detectors. Short the end-of-line resistor before metering the wire.

Resistance on the sensor loops for Points 2 to 6 must be less than 100Ω with the end-of-line resistor shorted and the detection devices connected.

Maximum wire length for the transformer is 50 feet (18 AWG, stranded).

Maximum wire length for all keypads is 500 feet (22 AWG).

EMI (Electro Magnetic Interference)

AC wiring can induce EMI (both noise and low level voltage) into adjacent wiring. Run phone and sensor loop wiring away from AC conductors, including the transformer wire. Run keypad wiring away from AC and phone wiring.

EMI may also occur if you install the panel or run system wires near the following:

- Computer network system
- Fluorescent fixtures
- Telephone cabling
- Ham radio transmitter site
- Heavy machinery and motors
- High voltage electrical equipment
- PBX telephone system
- Public Service (police, fire departments, etc.) using radio communications
- Radio station transmitter site, or other broadcasting station equipment
- Welding shop

If you think that EMI may be a problem, use shielded cable. The drain wire for the shielded cable must have continuity from the earth ground terminal on the control panel, to the end of the wire run.

Connect to Earth Ground

Terminal 3

To help prevent damage from electrostatic charges or other transient electrical surges, connect the panel to earth ground at the panel's earth ground terminal (terminal 3) before making any other connections.

A grounding rod or cold water pipe are recommended earth ground references.

Radionics does not recommend a telephone or electrical ground for the earth ground connection. Use 18 AWG wire maximum under the terminal. Use a spade lug or splice for a larger wire.

Do not connect any other panel terminals to earth ground. The panel's common terminals and earth ground terminal are electrically isolated.

Transformer

Terminals 1 and 2 (16.5VAC)

Connect the transformer to terminals 1 and 2 before plugging it into the power source.

Use 18 AWG wire to connect the transformer to the panel. Wire length should be kept as short as possible. Maximum wire length is 50 feet.

Never share the transformer with other equipment:

Foreign grounds on the AC input may damage the panel's power circuit.

Battery

Place the battery upright in the base of the enclosure. First plug the connector on the negative (black) battery wire to the negative (-) side of the battery.

Next plug the connector on the positive (red) battery wire to the positive (+) side of the battery.

D126 Battery required for fire and combined fire/burglary systems: In order to meet standby battery requirements, use the Radionics D126, 12v 7.0Ah battery for fire and combined fire/burglary systems.

Charge the Battery as You Work

Lock the Standby Switch

Locking the pin in the standby position allows you to charge the battery as you install the detection devices and

keypads. Lock the pin down now. See Figure 2.

With the Standby Switch locked down, the panel deactivates the external relay outputs, suppresses reports, and disables all arming functions.

Lock the Standby Switch down to program the panel locally, from the keypad, or the D5200.

Releasing the Standby Switch from the closed position resets the panel. The panel resets all its timers and counters, and clears all buffers. If the panel is armed, releasing the standby switch causes the panel to disarm.

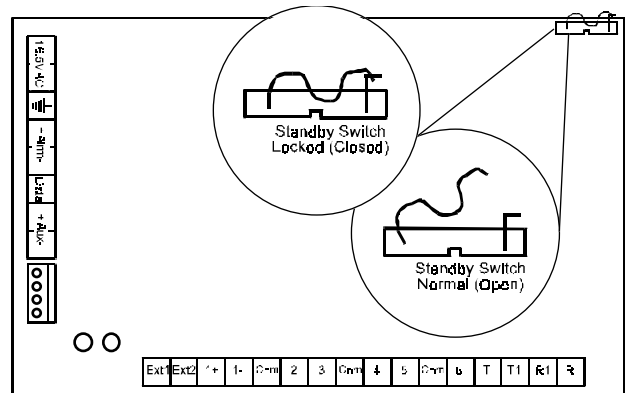

Figure 2: Standby Switch

Install Detection Devices, Keypads, and Bells

No Connection to the Panel Yet

Install and wire detection devices, keypads, and indicating devices (bells, sirens, or strobes for example) at their locations throughout the premises. DO NOT make the connections at the panel end of the wiring yet.

Number of Sensors

When using Point 1 as a fire point, the number of detection devices you can connect to its sensor loop is limited. See Point 1 on page 8.

The number of detection devices you can connect to the sensor loops for Points 2 to 6 is limited only by the resistance on the loop. Resistance must be less than 100Ω with the detection devices connected.

Continue Connections to the Panel

Power Down First

Unplug the transformer and disconnect the battery to make the remaining connections to the panel.

Alarm Output

Terminals 4 and 5 (+Alrm-)

The Alarm Output terminals provide a 10.2 VDC to 13.9 VDC output when activated. **The positive (+) terminal provides steady positive output.** The negative (-) terminal provides a pulsed or steady negative output as programmed.

Use this power for bells, siren drivers, piezo fire sounders, electronic horns, or other devices.

Available Power

The panel combines power produced by the power supply with power from the secondary power source (the battery) to produce a total of 1.35A of **alarm** power at the Alarm Output terminals.

D126 Battery required for fire and combined fire/burglary systems: In order to meet standby battery requirements, use the Radionics D126, 12 V 7.0Ah battery for fire and combined fire/burglary systems.

Fire System Power Formula

To calculate the current available at the Alarm Output terminals for fire and combined fire/burglary systems:

1. Add together the current draws for all devices connected to the negative alarm output terminal. This total is the current required for the **Normal Standby Condition (NSC)**. This total must be less than 140mA.
2. Subtract the NSC current required calculated in step 1 from the Primary Alarm Current, 860mA. The difference is the Alarm Current available for the Alarm Output terminals.

In formula format: Primary Alarm Current - NSC current required = Alarm Current available

Keypads

Terminals 6, 7, and 8 (Data, and +Aux-)

You can connect up to eight keypads to the panel.

The installation sheet packed with each keypad contains mounting instructions. Wire keypads to the panel in parallel as shown in Figure 3.

You must use a minimum of five feet of wire (22 AWG) when connecting the keypad to the panel. A short on the positive Aux terminal (terminal 7) within five feet of the panel prevents the panel from operating correctly.

Maximum wire length for all keypads connected to Data and Aux (+,-) terminals (terminals 6, 7, and 8) combined is 500 feet (22 AWG).

Extra power needed for more keypads. Review *Power Outputs* on page 12 to determine the total power output requirements for your system. Instructions for using stand alone power supplies are included.

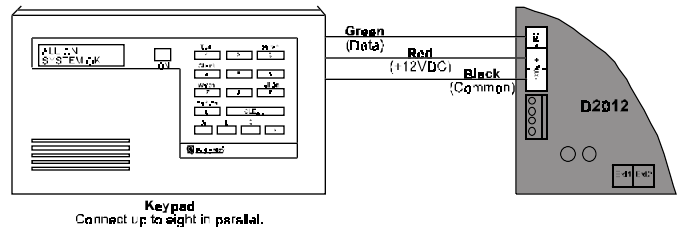

Figure 3: Keypad Wiring

Auxiliary Power Terminal 7 and 8 (+Aux)

The continuous current draw for powered devices connected to terminal 7, including keypads, must not exceed 500mA (140mA for fire and combined fire/burglary systems). Devices powered from this output must operate over a range of 10.2 VDC to 13.9 VDC.

You must use a minimum of five feet (22 AWG) of wire when connecting devices mounted outside the enclosure to terminal 7. A short on terminal 7 within five feet of the panel prevents the panel from operating correctly.

Checking Continuous Current Draw

The panel allows you to check current draw using the keypad. For more information about this and other keypad diagnostic features, see the *Keypad Diagnostics* manual (35117).

External Relays Terminals 9 and 10 (Ext1 and Ext2)

You can program the External Relay terminals (terminals 9 and 10) to provide outputs for two external relays. Review the *RELAYS Group* in the *Program Entry Guide* for a description of the relay functions available.

Connect a D133 (or D134) Relay Module for each of the external relay outputs you intend to use. Figure 4 shows the connections (the D134 combines the functionality of two D133 relays in a single enclosure.).

Warning: Do not connect wiring for external relays directly to terminals 9 and 10. Install D133 (or D134) modules connected to terminals 9 and 10 in the enclosure with the panel as shown in Figure 1.

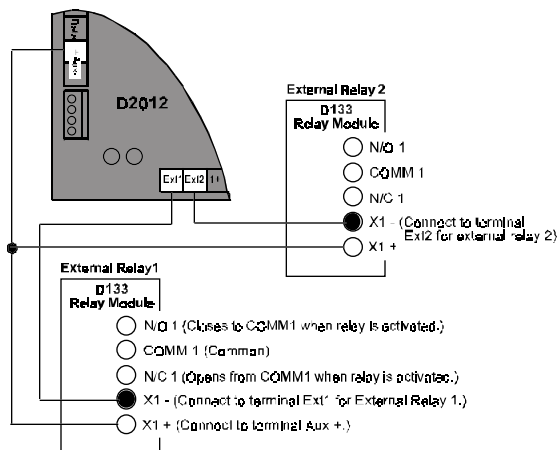

Figure 4: External Relay Wiring

Connect the Points

On-Board Points

Point 1 Terminals 11 and 12 (1+ and 1-)

Point 1 on the D2012 is a powered, supervised point.

The panel monitors the Point 1 sensor loop for normal, shorted, or open conditions. Programming determines how the panel responds to those conditions. See the *Program Entry Guide*.

Terminal 11 provides positive voltage to 2-wire detection devices. Terminal 12, the loop return (-), is isolated from earth ground.

The Keypad Reset function interrupts power to this sensor loop to reset smoke detectors.

Use a 2kΩ end-of-line resistor for Point 1. See Figure 5 on page 9 for point wiring.

Connecting Two-wire Smoke Detectors to Point 1:

Connect up to 15 Radionics D262 two-wire smoke detectors to Point 1. Refer to the *Technogram: Smoke Detectors Compatible with the D2012* (P/N 35119), for a complete list of detectors compatible with the D2012.

Do not mix compatible two-wire smoke detector types on this loop.

Four-wire Smoke Detectors

Connect any number (limited by available power and the Authority Having Jurisdiction) of 12 VDC four-wire smoke detectors to any supervised point. Install a suitable power supervision device according to the manufacturer's instructions. Route the power for the detectors through a D133 (or D134) Relay Module. The relay module must be connected to one of the panel's external relay outputs programmed for the reset function. See *RELAYS* in the *Program Entry Guide* for programming instructions.

Heat Detectors and Other Dry Contact Initiating Devices

Connect any number (limited by the Authority Having Jurisdiction).

Burglary Devices

Connect any number (limited by available power) of burglary devices to any point. Do not combine fire detection and burglary devices on the same point.

Points 2 to 6 Terminals 13 through 20

Points 2 to 6 are supervised, non-powered points.

The panel monitors sensor loops for normal, shorted, or open conditions. Programming for each point determines how the panel responds to those conditions. See the *Program Entry Guide*.

Terminate each sensor loop with a 1.0kΩ end-of-line resistor. See Figure 5 for point wiring.

Four-wire Smoke Detectors

Connect any number (limited by available power and the Authority Having Jurisdiction) of 12 VDC four-wire smoke detectors to any supervised point. Install a suitable power supervision device according to the manufacturer's instructions. Route the power for the detectors through a D133 (or D134) Relay Module. The relay module must be connected to one of the panel's external relay outputs programmed for the reset function. See *RELAYS* in the *Program Entry Guide* for programming instructions.

Heat Detectors and Other Dry Contact Initiating Devices

Connect any number (limited by the Authority Having Jurisdiction).

Burglary Devices

Connect any number (limited by available power) of burglary devices to any point. Do not combine fire detection and burglary devices on the same point.

For UL installations, wire a sounding device (such as a buzzer) to one of the external relays (terminals Ext1 and Ext2) and to terminal +Alrm (Alarm Output). See Figure 5. Program the relay for Function 3 to provide annunciation of troubles for all fire points (see *RELAYS Group* in the *Program Entry Guide*).

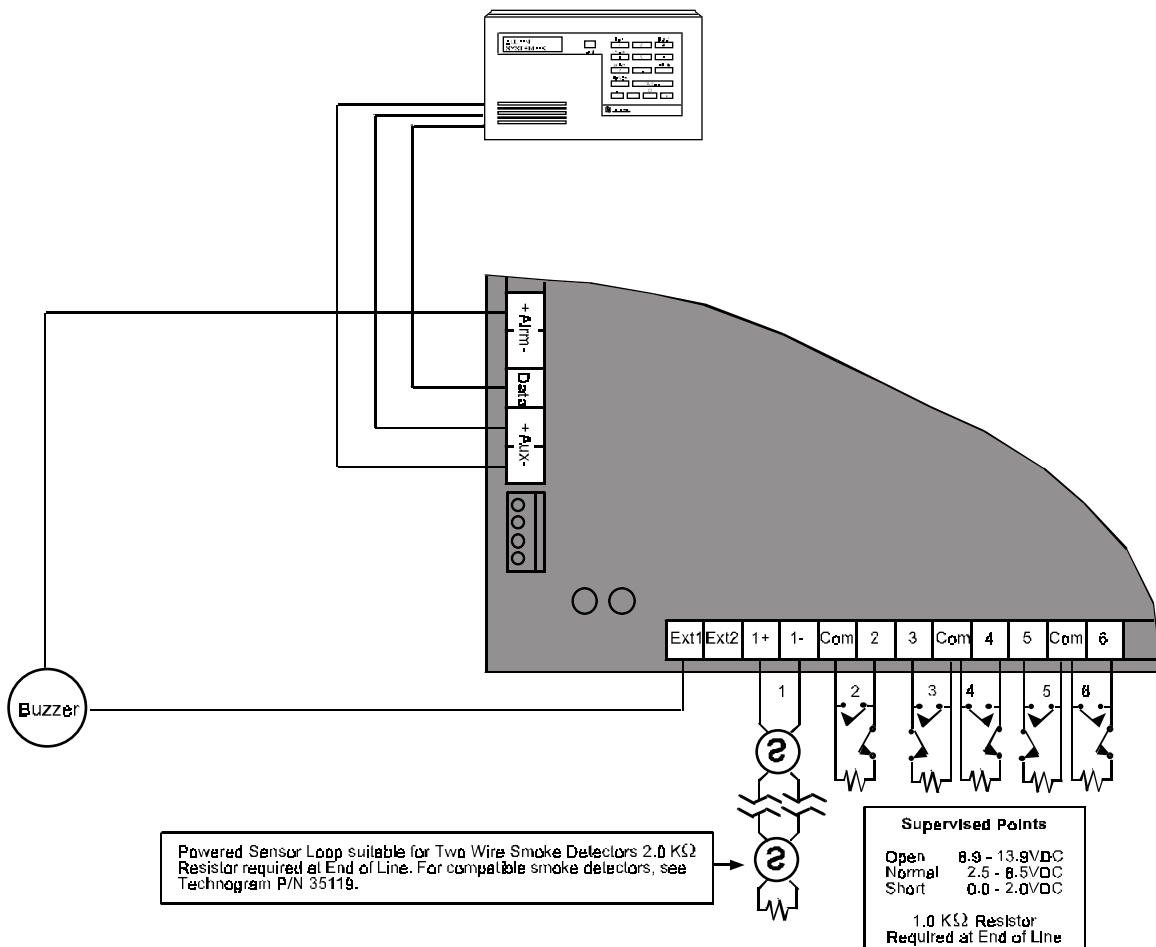

Figure 5: Points

Make the Telephone Connections

Phone Jack

To prevent jamming of reports, wire the RJ31X jack before the in-house phone system to support line seizure. See Figure 6. Line seizure provides for a temporary interruption of normal phone usage while the communicator transmits data.

After installation, confirm that the panel seizes the line, acquires dial tone, reports correctly to the receiver, and releases the phone line to the in-house phone system.

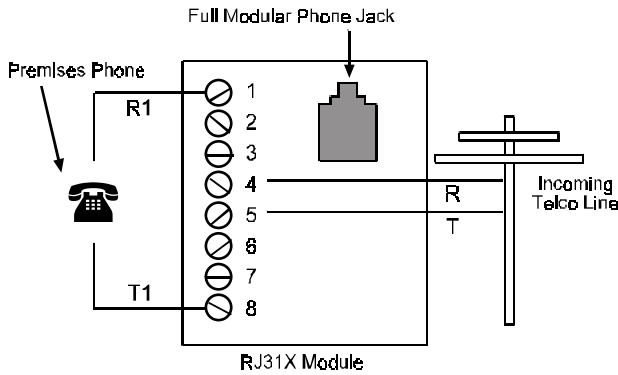

Figure 6: RJ31X Phone Jack

Phone Cord

Connect the flying leads of the D160 or D164 Phone Cord to the panel as shown in Figure 7. Connect the modular end to the RJ31X.

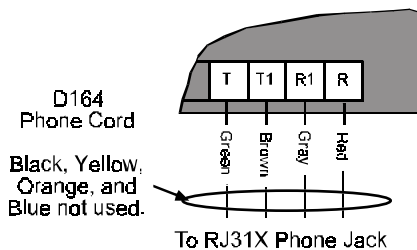

Figure 7: Phone Cord

Power Up

Connect the battery and then plug in the transformer.

Leave the Standby Switch locked down for now.

Program the Panel

Use the Keypad, Radionics D5200 Programmer, or a remote programmer to program the panel. See the *Program Entry Guide* for programming options and keypad programming instructions.

If you're programming from the keypad or using the D5200, make sure the Standby Switch is locked down. See Figure 8.

If you're using the D5200, Figure 9 shows the location of the programming jack. See the *D5200 Programming Operation Manual* for instructions on using the programmer.

Unlock the Standby Switch

When you're finished programming, move the Standby Switch to the normal position. See Figure 8. The panel sends a RE-BOOT report to the receiver and returns in the disarmed state. If you programmed for test reports and left the hours and minutes to next report prompts at 0 (zero), the panel sends a test report with the RE-BOOT report.

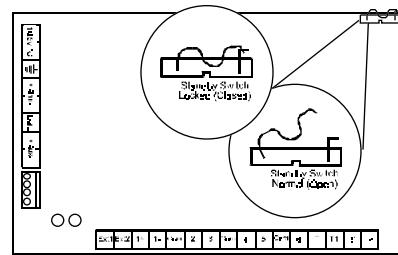
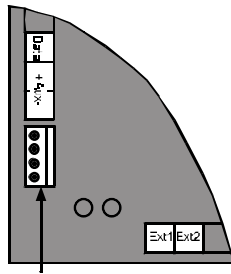

Figure 8: Standby Switch

RAM II ResetBye does not disarm the panel: After you unlock the standby switch, the panel returns to a disarmed state. Using RAM II *ResetBye*, however, does not affect the armed state of the panel.

Check for Alarm Verification

You must check the Alarm Verification box in the lower left hand corner of the Label if you programmed Point 1 for Fire with Verification (Digit 1 = 2). See *POINT CODES* in the *Program Entry Guide* for more information.



Local Programmer Connect
Lock standby switch to program.

Figure 9: Programmer Jack

Test the System

After finishing installation and programming, make a complete functional test of the system. Test the panel and all devices for proper operation. Test after you first program the panel and after any subsequent programming session.

Clear after test: To clear the alarm memory and report buffer, close the Standby Switch for 2 seconds, then release it. The panel returns to service in the disarmed state.

Detailed Description

Primary (AC) Power Circuit

A 16.5 VAC, 25VA transformer (Radionics model D1625) is the primary power source for the panel.

The AC power circuit provides 1.0 Amps of rectified DC power. The panel reserves 140mA of this power for internal operations and 500mA for continuously powered devices. Under alarm conditions 860mA of power is available for continuously powered and alarm indicating devices combined.

Transient suppressors and spark gaps protect the circuit from power surges. This protection relies on the ground connection. Make sure the panel's ground terminal is connected to a proper ground.

AC Power Failure

The panel indicates an AC power failure when power at the terminals labeled 16.5VAC is missing for 60 seconds. The *AC Fail Buzz/Rpt* program item sets the panel's response to detected AC failure. The panel indicates an AC power restoral 60 seconds after power restores to the terminals labeled 16.5VAC.

Secondary (DC) Power

A 12V, 4.0 Ah sealed lead-acid rechargeable battery (Radionics D1240) supplies secondary power for auxiliary and alarm outputs. The battery also powers the system during interruptions in primary (AC) power.

Lead Acid Batteries Only: The panel charging circuit is only calibrated for lead-acid batteries. Do not use gel-cell or nicad batteries.

Larger Battery Increases Backup Time: To increase battery backup time, connect a larger capacity battery, up to 7 Ah (Radionics D126).

Battery Replacement

Radionics recommends battery replacement every three to five years under normal use. Exceeding the maximum output ratings, or installing the transformer in an outlet that is routinely switched off, causes heavy discharges. Routine heavy discharges can lead to premature battery failure.

D135A Prevents Deep Discharge: The D135A Low Battery Cutoff Module protects the battery from deep discharge during extended power outages. Deep discharge can cause permanent battery damage.

Battery Supervision

When the battery drops to 12.1 VDC the keypad indicates a trouble condition. The panel transmits a `BATTERY LOW` report.

When the battery voltage returns to 13.0 VDC and there is AC power at the terminals labeled 16.5VAC, the keypad returns to normal operation. The panel transmits a `BATTERY RESTORAL` report.

Investigate low battery reports right away. If primary (AC) power is off and the discharge continues, the panel becomes inoperative when the battery voltage drops below 10.2 VDC.

If the battery is disconnected, it takes 60 seconds for the panel to recognize the condition.

Battery Charging Circuit Float Charge

The float voltage for the battery charging circuit is 13.9 VDC. Deduct any continuous load for devices connected to the panel from 860mA to find the maximum current available for charging. At 13.9 VDC the battery is fully charged and is maintained with a trickle charge of approximately 5mA.

Battery Discharge/Recharge Schedule (No AC Power)

Discharge Cycle

AC OFF The Keypad indicates trouble.
AC Fail reports if programmed.

13.9 VDC Charging float level.

12.1 VDC Low Battery reports.

10.2 VDC Panel shuts down below 10.2 VDC

Recharge Cycle

AC ON Panel restarts, battery charging begins,
AC restoral report sent.

13.0 VDC Battery restoral reports sent, the keypad
returns to normal operation.

13.9 VDC Battery float charged.

Power Outputs

D2012 Circuit Protection

Two self-resetting protection devices protect the panel from short circuits on both the auxiliary and alarm power outputs.

Bell circuit protection: A short on the alarm power output while the bell is ringing disables this output until it times out or you perform a panel reset.

Extra Power for Keypads

You may need to add one or more D8132 Battery Charger/Power Supply Modules for the number of keypads you want to use. Figure 10 shows the D8132 powering keypads in a stand-alone configuration.

For UL Certificated accounts, use a UL listed power supply. The D8132 is not UL listed as a stand-alone power supply for fire and burglary applications.

D2012 and D8132 (or other power supply) must share COMMON: Note that Figure 10 shows the common from the D8132 module connected to both keypad's common and the Aux- (common) terminal on the panel. Do not connect the stand-alone power supply to earth ground.

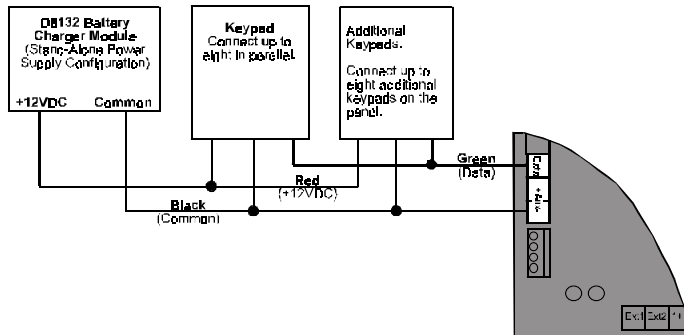

Figure 10: Power for Keypads

Telephone

Dialing Format

You can program the panel to use DTMF or pulse dialing. See *Phone Parameters* in the *Program Entry Guide*.

Communication Failure

After 5 attempts to reach the receiver (10 attempts if two phone numbers are programmed), the panel goes into communication failure. The panel clears any reports in its phone buffer. The panel sounds a tone at the keypad indicating trouble.

Pressing the Clear key silences the tone. When communication restores (a report is acknowledged by the receiver), the keypad returns to normal operation.

Ground Start

Some telephone systems require a momentary ground input to initiate dial tone. To interface with a ground start system, connect a D133 (or D134) relay as shown in Figure 11. See *RELAYS Group* in the *Program Entry Guide* for instructions on programming the external relay output for Ground Start.

The panel's ground terminal must be connected to an earth ground reference.

Warning: You cannot use ground start phone systems for fire or combined fire burglary systems.

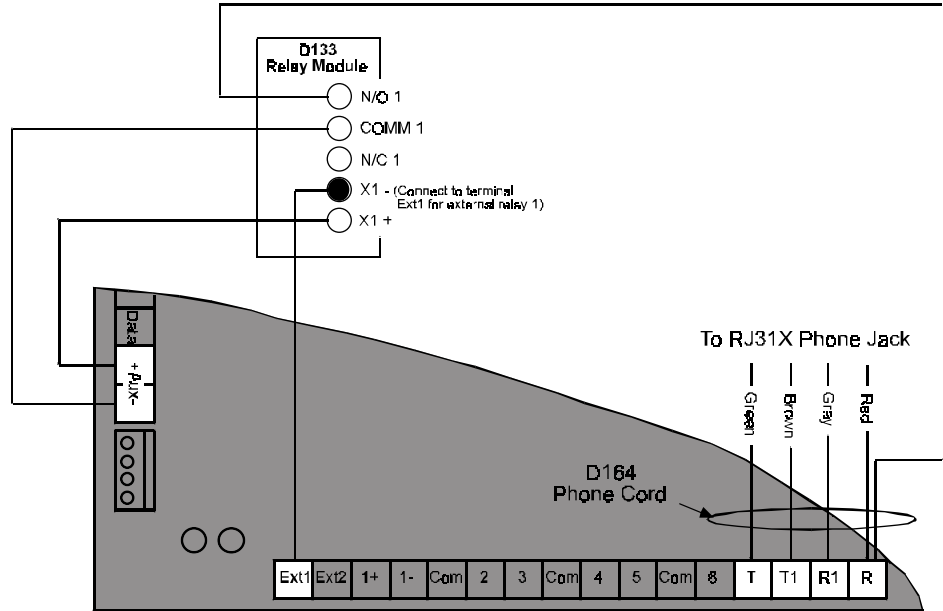

Figure 11: D133 for Ground Start

Points

Point Parameters

On-Board Point 1

Point 1 is a powered sensor loop. Review the Radionics *Technogram: Smoke Detectors Compatible with the D2012* (P/N 35119) for a list of compatible detectors.

Point 1 is supervised with a 2K EOL resistor.

Points 2 to 6

Points 2 to 6 are supervised with 1.0K resistors.

Open Loop = Greater than 8.9 VDC, but less than 13.9 VDC.

Normal Loop = Greater than 2.5 VDC, but less than 8.5 VDC.

Shorted Loop = Greater than 0.0 VDC, but less than 2.0 VDC.

Point Response Time

The panel scans point sensor loops every 500 milliseconds. A point must be faulted for 2 scans (one second) before the panel initiates an alarm.

Keyswitch

Description

You can connect a momentary contact arming station (keyswitch) to turn the D2012 on and off. Connect the keyswitch to any point sensor loop.

You can use the external relay outputs and D133 (or

D134) Relay Modules to activate arming status lights or keyswitch arming stations. See the *Relays* section in the *Program Entry Guide*.

Programming

See the POINT CODES Group in the *Program Entry Guide* for the correct programming for points used for keyswitches.

Installation

Connect the end-of-line resistor for the point at the keyswitch so that the switch shorts the resistor when it operates. An open on the circuit produces an alarm if the area is armed and a trouble if it is disarmed. See Figure 12.

Keyswitch Operation

Shorting and restoring the point sensor loop toggles the system ON and OFF. All faulted points are bypassed. See the POINT CODES Group in the *Program Entry Guide*.

Silencing the Bell

To silence the bell (stop Alarm Output) if the system in ON (or part ON), operate the keyswitch to turn the system OFF. If the area is OFF, operating the keyswitch only silences the bell. It does not turn the system ON.

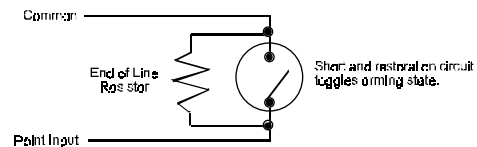

Figure 12: Keyswitch

Easikey

You can use a Radionics Easikey access system to turn the system OFF. Program the *Keyswitch* prompt to Easikey. See the *Program Entry Guide* for instructions. You must use a 12 VDC option for the Easikey installation. See *Easikey Installation and Operation Instructions*. Easikey is not for use in UL installations.

Connect the Easikey door controller to the panel using a D133 Relay Module as shown in Figure 13. Make certain to connect the common for the Easikey's 12 VDC supply to the terminal labeled Aux- on the panel.

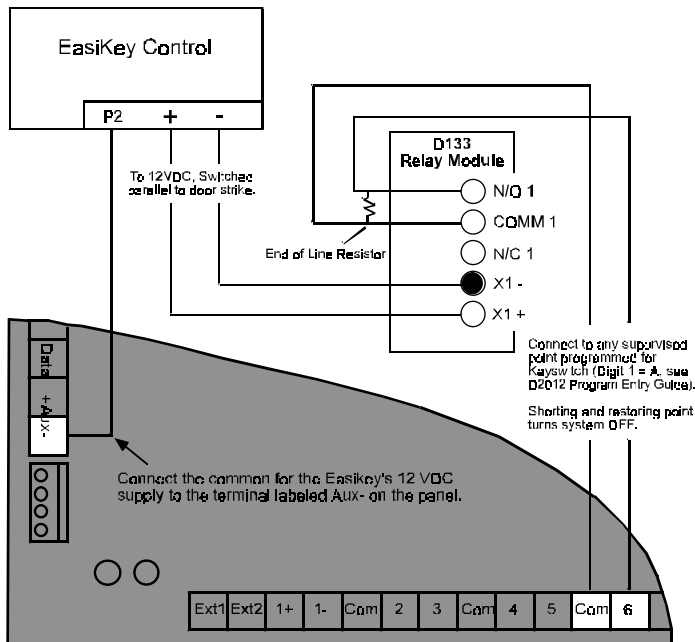

Figure 13: Keyswitch

Installation Guide for UL Applications

Introduction

The *System Chart* references components evaluated and listed by Underwriters' Laboratories for compatibility with the panel. These components meet the basic system requirements for the applicable standard.

The *System Wiring Diagram, Issue A* shows the relationship between the panel and the accessory components referred to in the *System Chart*. See the installation and operation instructions for each component for detailed instructions.

Optional Compatible Equipment

You can use UL listed components that do not require evaluation for electrical compatibility in many applications when installed in accordance with the manufacturer's instructions.

Burglary Applications

You can use UL listed burglary alarm sensors that do not require evaluation for electrical compatibility in burglary applications. In some cases you must use a UL listed Radionics interface module in conjunction with the sensors. Consult the individual component specification and installation documents to determine suitability.

In burglary applications with one 7.0 Ah, 12 VDC battery, the panel supports an auxiliary output of 680mA and an alarm (bell) output of 1.35A configured as necessary. For additional loadings refer to the *Current Rating Chart for Standby Battery Calculations*.

For commercial burglary installations, use a maximum of 45 seconds of entry delay and a maximum of 60 seconds of exit delay.

Test Weekly: UL Standard 1023 requires a weekly test. Configure the User System Test to test the battery. See *Configuration* in the *Program Entry Guide* for instructions.

Fire Applications

You can use UL listed fire initiating devices not requiring electrical compatibility evaluation in any application. For example: four-wire smoke detectors, heat detectors, waterflow switches, and manual pull stations are suitable fire initiating devices. Consult the individual component specification and installation documents to determine suitability.

When using four-wire smoke detectors, install a suitable power supervision unit according to the manufacturer's instructions. Use the D133 (or D134) Relay Module to provide reset capability.

In fire applications with one 7.0Ah, 12 VDC battery, the panel supports an auxiliary output of 140mA and a bell output of 720mA configured as necessary. For additional loadings refer to the *Current Rating Chart for Standby Battery Calculations*.

Two-wire detectors must be electrically compatible, and must be UL listed for use with the D2012. See the Radionics *Technogram: Smoke Detectors Compatible with the D2012* (P/N 35119), or you may contact the detector manufacturer.

Test Weekly: Radionics recommends testing fire and combined fire/burglary systems weekly. Configure the User System Test to test the battery. See *Configuration* in the *Program Entry Guide* for instructions.

For all Burglary applications, the panel must be programmed to send a supervisory signal to the central station a minimum of once every 24 hours. Do not set or program an automatic telephone dialer or similar device to place a call to a police station number that is not specifically assigned by that station for such service.

Sounding Device

The sounding device shall operate for at least four minutes before an automatic cutoff for Household Burglary applications and at least 15 minutes for Commercial Burglary applications.

For all Commercial Burglary applications, the system must be programmed to sound the audible device every time the system is armed.

Enclosures

The **D2803** enclosure is suitable for Household Fire and Burglary applications only.

Enclosure tamper protection causing an immediate alarm signal is required for all burglary applications.

Radionics offers three optional enclosures:

The **D8103** enclosure is suitable for residential fire and/or burglary installations and commercial applications. See *System Chart* for acceptable applications.

The **D8109** is normally used for fire alarm applications. The D8109 is approved by the Factory Mutual, California State Fire Marshal, and the New York City Materials and Equipment Acceptance System.

The **D8108A** is attack resistant. It is intended primarily for UL commercial burglary and mercantile safe and vault applications requiring a local bell. You can use the D8108A in an burglary application where the D8103 or D8109 enclosure is suitable. The D8108A is approved by the Factory Mutual, California State Fire Marshal, and the New York City Materials and Equipment Acceptance System.

(The System Chart can be found on the following page.)

The D2012 control panel is suitable for Police Station connect applications, including Grade A Mercantile Premises and Grade A Mercantile Safe and Vault alarm systems. Suitable for Grade AA Mercantile Premises and Grade AA Mercantile Safe and Vault alarm systems when the Model D2012 DACT unit is installed in conjunction with the Model D8122 derived channel subscriber terminal unit. For all Police Station applications and grades, the Model D8108A Attack Resistant Enclosure with a UL listed local sounding device is required. Per UL 365, keyswitches mounted outside the protected area must employ high security locking cylinders complying with the requirements for key locks, UL 437. Tamper protection must also be provided.

The D2012 control panel is suitable for Local, Grade A Mercantile Premises and Local, Grade A Mercantile Safe and Vault alarm systems. For all Local applications and grades, the D8108A Attack Resistant Enclosure and a UL listed Local sounding device are required. Per UL 609, when keyswitches are mounted outside the protected area, tamper protection must be provided.

The D2012 control panel is suitable for Central Station, Grade C applications. It is suitable for Central Station, Grade B applications when the Model D2012 DACT unit is installed with a UL listed Local sounding device. Also suitable for Central Station Mercantile, Grade AA applications when installed with the Model D8122 derived channel subscriber terminal unit.

The D2012 control panel is suitable for Proprietary Burglar Alarm, Grade C applications. Also suitable for Proprietary Burglar Alarm, Grade B applications when Model D2012 DACT unit is installed with a UL listed Local sounding device. Also suitable for Proprietary Burglar Alarm, Grade AA when the Model D2012 DACT unit is installed with a Model D8122 derived channel subscriber terminal unit.

The D2012 control panel is suitable for Household, Grade A applications.

UL Standard 681 for Installation and Classification of Mercantile and Bank Burglary Alarm systems requires foil lining of equivalent protection of the control unit enclosure. The D8108A enclosure does not have foil lining, but acceptable protection can be provided by mounting electronic vibration sensors inside the enclosure. ***Proximity alarms (capacitance) cannot be used for this purpose.***

Install electronic vibration sensors in the D8108A enclosure that are identical to those used to protect the safe or the vault. Sentrol 5402, Potter EVD-S, or Arrowhead S-3810 electronic vibration detection (EVD) systems which can be mounted inside the enclosure meet the requirements of UL 681. Mount the electronic vibration sensor directly inside the metal cabinet of the D8108A. Do NOT install the sensor within a quarter inch (1/4") of the components or traces of the printed circuit assembly.

System Chart

	Household Burglary (Grade A)	Household Fire	Household Fire / Burglary Combined	Central Station Burglary (Grade C)	Police Connected Burglary	Local Burglary	Proprietary Burglary	Local Fire / Burglary Combined	Local Fire	Local and Central Station Fire Combined	Local and Central Station Fire / Burglary (Grade C)	Central Station Fire / Burglary (Grade C)	Central Station Fire	Electrically Actuated Transmitter	
NFPA Standard		72	72					D2012 not listed for these applications							
Minimum Hours of Standby Battery	4	24 + 4 mins alarm	24 + 4 mins alarm	4	4	4	4	Key No = Not acceptable for this application. Req. = Require for this application. Opt. = Optional for this application. 1+ = One or more required for this application. Consult the appropriate standard. 2+ = Two or more required for this application. Consult the appropriate standard. 1* = At least one detector required. You can substitute other 2-wire detectors listed for use with the D2012. You could use the D262 with the D270 four-wire base or other manufacturer's four-wire detectors. You must use a listed power supervision relay with four-wire detectors. ◆ = Listed bell (siren) housing required for burglary alarm bell or siren. □ = (Empty box) Not used for this application. * = D101 required for D8103 enclosure							
D2803 Enclosure	Included with panel			No	No	No	No								
D8103 Enclosure	Optional			Choose One	No	No	No								
D8108A Enclosure	Optional				Req.	Req.	Req.								
D8109 Enclosure	Optional				No	No	No								
D126 Battery	Opt.	1	1	Opt.	Opt.	Opt.	Opt.								
D127 Reversing Relay	Opt.	No	Opt.	Opt.	Opt.	Opt.	Opt.								
D164 Telephone Cord	Required to connect panel to RJ31X Telco Block														
D202A, D220A, D223 Command Center	1+	1+	1+	1+	1+	1+	1+								
D262 Smoke Detector Head D261 Base		1*	1*												
D431, D435, D438, D440, D442, D448 Indicating Device	1+	1+	1+	Opt.	◆	◆	◆								
D1240 Battery	1	No	No	1	1	1	1								
D1625 Transformer	Required for all applications														
D8004 Transformer Enclosure	Opt.	Opt.	Opt.	Opt.	Opt.	Opt.									
D8122 Derived Channel S.T.U.	Optional, contact TelCo for availability of derived channel service														
D8130 Release Module	Optional														

Standby Battery Requirements

Household Burglary and Commercial Burglary
Four hours of standby battery capacity required.

Standby Battery Calculation for Fire Alarm Applications NFPA 72 (Chapter 2) Household Fire Warning Equipment

The NFPA (Chapter 2) Household Fire Warning Equipment Standard requires 24 hours of standby plus four minutes (.067 hrs) of alarm operation at the end of the 24 hour period.

You must use battery ampere hour (Ah) calculations to verify compliance. The formula in the next column includes a 10% contingency factor for depletion of battery capacity with age.

NFPA 72 (Chapter 2) Ampere-Hour Calculation Formula

(Total B ___ x 24 Hrs) + (Total C ___ x .067 Hrs) + (10% Contingency) = Total Ah required.

Total Ah requirements must not exceed Ah capacity of batteries.

Note: For Battery Calculations:

When system is idle, running on battery only, the current draw from the battery is 125mA.

When the system is in communication, running on battery only, and set for pulse dialing, the current draw from the battery is 190mA.

Specifications

Primary Power Supply

- 16.5 VAC 25 VA class 2 plug-in transformer (D1625)

Secondary Power Supply

- 12 VDC 4.0 Ah sealed lead acid rechargeable battery.
7.0 Ah battery required for Fire and combined Fire/Burglary systems.

Auxiliary Power Output

- 500mA maximum at 10.2 VDC to 13.9 VDC for devices powered at the Aux+ terminal (140mA for Fire and combined Fire/Burglary systems).

Alarm Power Output

- 1.35 A maximum at 10.2 VDC to 13.9 VDC output. Output may be steady or pulsed (Temporal Code 3) depending on programming.

Fire and Fire/Burglary Systems

To comply with UL 985 listing standards for household fire alarm systems (effective March 1, 1989), the total combined continuous and alarm current draw for the system **during alarm conditions** must be limited to 860mA provided by the primary power supply (rectified AC).

Operating Voltage

- 10.2 VDC (minimum) 13.9 (maximum)

Telephone Connection

- RJ31X or RJ38X jack interfaced with D164 phone cord.

Environmental

- Temperature: 32° - 122°F (0° - 50°C)
- Relative Humidity: 5 - 85% at 86°F (30°C) non-condensing

Arming Stations

- D202A Keypad
- D205 Keypad
- D206 Keypad
- D220A Keypad
- D223 Keypad
- Keyswitch
- Easikey

Compatible Enclosures

- D2803 Standard Enclosure
- D8103 Universal Enclosure
- D8109 Fire Enclosure
- D8108A Attack Resistant Enclosure

Compatible Accessories

See the Radionics Product Catalog for complete list.

- D126 12V, 7 Ah Rechargeable Battery
- D127 Reversing Relay
- D133 Relay Module
- D134 Dual Relay Module
- D135A Low Battery Cutoff Module (not UL listed)
- D164 Phone Cord
- D169 2-Way Voice Verification Module
(*NOT UL Listed. NOT suitable for Fire and combined Fire/Burglary installations. NOT suitable for UL Certified Burglary installations*)
- D202A Keypad
- D220A Keypad
- D223 Keypad
- D250 Heat Detector Base
- D254 135° Fixed Point Thermostat
- D255 190° Fixed Point Thermostat
- D440 (6"), D442 (10") Bells
- D448 12 VDC Horn
- D1240 12V, 4 Ah Rechargeable Battery
- D126 12V, 7 Ah Rechargeable Battery
- D1625 16.5 VAC 25 VA Transformer
- D5200 Programmer
- D5300 Remote Account Manager II
- D8004 Transformer Enclosure
- D8121A/D8122 Derived Channel S.T.U. (use D8122 for UL systems)
- Easikey (not for use in UL systems)
- D261A Smoke Detector Base
- D262 Smoke Detector Head

D2012 Terminal Quick Reference

Terminal		Description	
1,2	16.5VAC	16.5 VAC	Connect D1625, 16.5, 25VA Transformer for primary power.
3	∇	Earth Ground	Connect to earth ground. A cold water pipe or grounding rod is preferred. Do not connect to telephone or electrical ground.
4	+Alrm	+ Alarm Output	Continuous positive output provides 1.35 Amps at 10.2 to 13.9 VDC. Protected against overcurrent by self resetting device.
5	Alrm-	- Alarm Output	Switched negative output for steady or pulsed (temporal code 3) alarm output.
6	Data	Data	Data for keypads.
7	+Aux	+ Aux Power	Positive output for continuously powered devices, 500mA at 10.2 to 13.9 VDC. Protected against overcurrent by self resetting device.
8	Aux-	- Aux Power	Negative (common) for Aux Power and Relay Outputs.
9	Ext1	External Relay 1	Connect D133 or D134 relay for Form C Dry Contact.
10	Ext2	External Relay 2	Connect D133 or D134 relay for Form C Dry Contact.
11	1+	Positive Point 1	Positive Power for Point 1. Switched for sensor reset. Use for approved 2 wire smoke or glass break detectors.
12	1-	Negative Point 1	Negative Power for Point 1.
13	Com	Common	Common for Point 2.
14	2	Point 2	Input for Point 2.
15	3	Point 3	Input for Point 3.
16	Com	Common	Common for Points 3 and 4.
17	4	Point 4	Input for Point 4.
18	5	Point 5	Input for Point 5.
19	Com	Common	Common for Points 5 and 6.
20	6	Point 6	Input for Point 6.
21	T	Tip	Tip of incoming phone line.
22	T1	Tip1	Tip of phone line to premises phone.
23	R1	Ring1	Ring of phone line to premises phone.
24	R	Ring	Ring of incoming phone line.





O&I Menu



Documents by Type Menu



Documents by Product Menu



Main Menu



Radionics