

---

# Contents

---

---

## Section 1

<b>Introduction</b> .....	<b>1-1</b>
1.1 About This Manual .....	1-1
1.2 Optional Accessories .....	1-2

## Section 2

<b>Agency Listings and Requirements</b> .....	<b>2-1</b>
2.1 Federal Communications Commission (FCC) .....	2-1
2.2 Underwriters Laboratories (UL) .....	2-2
2.2.1 Requirements for All Installations .....	2-2
2.2.2 Requirements for Central Station Fire Alarm Systems .....	2-2
2.2.3 Requirements for Auxiliary Protected Fire Alarm Systems for Fire Alarm Service .....	2-3
2.2.4 Requirements for Remote Station Protected Fire Alarm Systems, for Digital Communication or Polarity Reversal .....	2-3
2.3 California Fire Marshal (CFM) .....	2-3
2.4 Factory Mutual (FM) .....	2-3
2.5 Materials and Equipment Board of Acceptance Division (MEA) .....	2-3

## Section 3

<b>Control Panel Installation</b> .....	<b>3-1</b>
3.1 Electrical Specifications .....	3-1
3.2 Environmental Specifications .....	3-1
3.3 Wiring Specifications .....	3-2
3.4 Model 5207 Wiring Diagram .....	3-3
3.5 Current Draw Worksheet .....	3-4
3.5.1 Worksheet Example .....	3-5
3.5.2 Worksheet Requirements .....	3-6
3.6 Power Supply Wiring .....	3-8
3.6.1 Connecting the 5198 to AC Power .....	3-9
3.6.2 Connecting the 5198 to Batteries .....	3-9
3.7 Mounting the 5207 .....	3-9
3.8 Terminal Strip Description .....	3-10
3.9 Telephone Line Connection .....	3-12
3.10 Cable Connectors .....	3-13

## Section 4

<b>Compatible Product Installation</b> .....	<b>4-1</b>
4.1 Class A (Style D) Zones .....	4-1
4.2 Class B (Style A) Zones .....	4-2
4.3 Four-Wire Smoke Detector Connection .....	4-3
4.4 Two-Wire Smoke Detector Connection .....	4-4
4.5 Model 4180 Status Display Module .....	4-4
4.6 Model 5210 Zone Expander Wiring .....	4-6
4.7 Model 5220 Direct Connect Module .....	4-7
4.7.1 City Box Connection .....	4-7
4.7.2 NFPA 72 Polarity Reversal .....	4-8
4.8 Keltron 95M3158 Tones Transmitter Module .....	4-9
4.9 Model 5230 Remote Annunciator .....	4-10
4.9.1 Setting ID Codes .....	4-10

4.9.2 5230 Permanent Connection . . . . .	4-11
4.9.3 Mounting the 5230 Remote Annunciator . . . . .	4-12
4.9.4 Temporary Annunciator Connection . . . . .	4-12
4.10 Model 5395 Signal Power Expander . . . . .	4-13
4.11 Model 7181 Zone Converter. . . . .	4-14
4.12 Supervised Notification Appliance Outputs . . . . .	4-15
4.13 Auxiliary Relays . . . . .	4-16
<b>Section 5</b>	
<b>Operation . . . . .</b>	<b>5-1</b>
5.1 Built-in Touchpad and Model 5230 Operation. . . . .	5-2
5.1.1 Built-in Touchpad Display Codes . . . . .	5-4
5.1.2 LED Indicators . . . . .	5-5
5.2 System Testing . . . . .	5-5
5.2.1 Fire Drills . . . . .	5-5
5.2.2 Walk Test (Mode 22) . . . . .	5-6
5.2.3 Automatic Self Test . . . . .	5-6
5.3 Watchdog Circuit . . . . .	5-6
<b>Section 6</b>	
<b>Programming: Quick Reference . . . . .</b>	<b>6-1</b>
<b>Section 7</b>	
<b>Programming: Step-by-Step Complete Reference . . . . .</b>	<b>7-1</b>
7.1 Using Step Programming . . . . .	7-1
7.1 Programming Examples . . . . .	7-3
7.2 Step Programming Options. . . . .	7-4
Step 1. Power Up Clear . . . . .	7-4
Step 2. Device Enables . . . . .	7-4
Step 3. More System Options . . . . .	7-5
Step 4. Display Rate . . . . .	7-5
Step 5. Miscellaneous Options . . . . .	7-6
Step 6. Internal Zone Options . . . . .	7-6
Step 7. External Zone Options . . . . .	7-9
Step 8. Number of Zones . . . . .	7-10
Step 9. Dialer Options . . . . .	7-10
Step 10. Total Number of Attempts . . . . .	7-11
Step 11. Number of Events Before Dialer Failed . . . . .	7-11
Step 12. Low AC Hours . . . . .	7-11
Step 13. Number of Rings . . . . .	7-11
Step 14. Report to Telephone Numbers . . . . .	7-12
Step 15. Computer Phone Number . . . . .	7-13
Step 16. Central Station Phone Numbers . . . . .	7-13
Step 17. Central Station Account Numbers . . . . .	7-13
Step 18. Dialer Format and Number of Attempts . . . . .	7-14
Step 19. Telephone Line to Use for Accounts . . . . .	7-14
Step 20. Duration of Delays . . . . .	7-15
Step 21. Test Time . . . . .	7-16
Step 22. Secret Codes . . . . .	7-16
Step 23. Group Relays and Bells . . . . .	7-17
Step 24. Alarm Relays and Bells (by Zone) . . . . .	7-19
Step 25. Zone Types . . . . .	7-20
Step 26. Zone Location Descriptions . . . . .	7-21
Steps 27 and 28. Temporal Patterns . . . . .	7-22

<b>Section 8</b>	
<b>Reporting</b>	<b>8-1</b>
8.1 Notes for All Formats	8-1
8.2 SIA Format Printed Messages	8-2
8.3 FSK & SK 4+2 Format	8-4
8.4 16-Zone 4+2 Format	8-5
8.5 Radionics BFSK Format	8-6
<b>Section 9</b>	
<b>Troubleshooting</b>	<b>9-1</b>
9.1 Problems With the Model 5198 Power Supply	9-1
9.1.1 Isolating the Problem	9-1
9.1.2 Measuring Battery Charging Voltage	9-1
9.2 P3 and P4 Earth Ground Faults	9-2
9.3 Accu-Zone® Troubleshooting (Mode 25)	9-2
9.3.1 Mode 25 Display	9-2
9.4 Troubleshooting and System Messages	9-4
<b>Appendix A</b>	
<b>Compatible Devices</b>	<b>A-1</b>
A.1 Smoke Detectors	A-1
Two-Wire Smoke Detectors	A-1
Four Wire Smoke Detectors	A-3
A.2 Notification Appliances	A-3



---

# Section 1

## Introduction

---

---

The Model 5207 is an 8-zone fire alarm control panel (expandable up to 16 zones) with a digital communicator that meets NFPA 72 requirements. The 5207 cabinet can be surface mounted or semi-flush mounted.

### 1.1 About This Manual

---

The *Model 5207 Fire Control/Communicator Installation Manual (P/N 150865)* is intended for those persons involved with the installation and maintenance of the 5207 panel. It is a comprehensive guide, providing detailed instructions, and should be kept for reference. As much as possible, we have tried to organize the manual chronologically by the tasks that need to be performed.

This manual is intended to be used with printed circuit board (PCB), Revision M. If you are using a different board, contact Silent Knight Security Systems for the appropriate instructions.

#### **IMPORTANT:**

Previous versions of the 5207 were selectable between 12V and 24V. This release is 24V only. \*All information regarding 12V have been removed from this manual.

Some versions of the 5207 product documentation were made up of two manuals, one for hardware installation and one for programming. We have combined both manuals into one. With the exception of information about the obsolete 5521 programmer\*, this manual contains all information previously contained in the two manuals.

*\*Contact Silent Knight if you need this information.*

<b>KEY</b>	A clear rectangle represents a key that you press on a touchpad.
LCD DISPLAY MESSAGE	The font shown to the left represents messages that you see on a liquid crystal display (LCD) or the seven-segment (built-in touchpad) display.
1-1, 2-3, etc.	This manual is organized into sections. Section numbers are part of the page numbers. For example, 1-1 means Page 1 of Section 1.

## 1.2 Optional Accessories

---

**Table 1-1: Compatible Modules  
Manufactured by Silent Knight**

Model	What It Does
4180 Status Display/Relay Module	For remote annunciation of alarm and trouble status information for each zone.
5210 Zone Expander	Adds 8 zones to the 5207 for a total expansion of the system to 16 zones.
5220 Direct Connect Module	For direct alarming and trouble transmission from the 5207 to a supervising station.
5230 Remote Annunciator	For remote annunciation, operation, and on-site programming.
Quick connect program cable, part number 130294	For temporarily connecting the 5230 to the 5207 for programming.
5395 Signal Power Expander	Notification circuit power for additional notification appliances. Provides additional 6A of 24 VDC, supervised.
5541 Downloading Software	For remote programming of the 5207 using a personal computer.
5530 Modem	Modem for downloading; required if the 5541 software is used.
7181 Zone Converter	Converts a zone from class B to class A or from class A to class B. One 7181 per zone to be converted.

---

## Section 2

# Agency Listings and Requirements

---

---

### 2.1 Federal Communications Commission (FCC)

---

1. If requested by the telephone company, the following information must be provided before the 5207 can be connected to the phone lines:
  - A. Manufacturer: Silent Knight Security Systems
  - B. Model Number: 5207
  - C. FCC registration number: AC6USA-65475-AL-E  
Ringer equivalence: 0.9B
  - D. Type of jack (to be installed by the telephone company): RJ31X
2. This device may not be directly connected to coin telephone or party line services.
3. This device cannot be adjusted or repaired in the field. In case of trouble with the device, notify the installing company or return to:

Silent Knight Security Systems  
7550 Meridian Circle  
Maple Grove, MN 55369-4927  
612-493-6455  
800-328-0103
4. If the 5207 causes harm to the telephone network, the telephone company will notify the user in advance that temporary discontinuance of service may be required. When advance notice is not practical, the telephone company will notify the user as soon as possible. Users have the right to file complaints, if necessary, with the Federal Communications Commission.
5. The telephone company may make changes in its facilities, equipment, operations, or procedures that could affect the operation of the equipment. If this happens, the telephone company will provide advance notice to allow you to make the necessary modifications to maintain uninterrupted service.

**Warning**

This device has been verified to comply with FCC Rules Part 15. Operation is subject to the two following conditions: (1) This device may not cause radio interference; and (2) This device must accept any interference received including interference that may cause undesired operation.

## 2.2 Underwriters Laboratories (UL)

---

The 5207 is UL Listed as a control unit for use in Central Station Fire-Protective Signaling systems. If the 5207 and its accessories are to be used as part of a UL installation, carefully read the UL requirements in this section. The following applicable NFPA 72 standards can be found in more detail in the *NFPA 72 National Fire Alarm Code, 1993 Edition*:

### Chapter 3

- Local Protected Fire Alarm Systems, Chapter 4

### Chapter 4

- Central Station Fire Alarm Systems
- Auxiliary Protected Fire Alarm Systems for Fire Alarm Service (City Box)
- Remote Station Protected Fire Alarm Systems (Polarity Reversal)
- Proprietary Fire Alarm Systems

### 2.2.1 Requirements for All Installations

General requirements are described below. The sections that follow describe additional requirements for the type of installation (for example, Central Station Fire Alarm systems, Local Protected Fire Alarm systems, and so on).

1. All field wiring must be 18-gauge or larger (for example, 16, 14, and so on).
2. Use UL listed smoke detectors compatible with the 5207. Refer to Appendix A.
3. Use UL listed compatible notification devices. Refer to Appendix A.
4. All notification devices must be UL listed.

### 2.2.2 Requirements for Central Station Fire Alarm Systems

1. The Ground Fault Detection option must be selected (programming Step 5).
2. The Phone Line #2 Enable option must be selected (programming Step 9).
3. The Phone Line Monitor Enable option must be selected (programming Step 9).
4. Set the Total Attempts option for between 5-10 attempts (programming Step 10).
5. Do not select the Ground Start Option (programming Step 9).
6. Enable the automatic daily test by selecting a phone number for the Report Test to Phone #1-4 option (programming Step 14.4).
7. On class A (style D) zones, the number of waterflow devices is limited to five.
8. Auxiliary relays may not be programmed to activate for Pre-Alarm. See Section 4.13.



### **2.2.3 Requirements for Auxiliary Protected Fire Alarm Systems for Fire Alarm Service**

1. Follow the current load restrictions shown in Section 3.5.
2. The Model 5220 Direct Connect module must be installed (see Section 4.7 for wiring).

### **2.2.4 Requirements for Remote Station Protected Fire Alarm Systems, for Digital Communication or Polarity Reversal**

1. Follow the current load restrictions shown in Section 3.5.
2. Use the 5207's built-in dialer or install the Model 5220 Direct Connect Module (see Section 4.7).

## **2.3 California Fire Marshal (CFM)**

---

The CFM approval number for the 5207 is 7165-0559:111.

## **2.4 Factory Mutual (FM)**

---

The Model 5207 is FM approved under project # OQ1A3.AY when used with the Silent Knight Model 9000 Receiver.

## **2.5 Materials and Equipment Board of Acceptance Division (MEA)**

---

The 5207 is approved under MEA. Approval was previously given from the City of New York Board of Standards and Appeals (BSA), the 5207 is still approved under BSA Calendar Number 703-88-SA.



---

## Section 3

# Control Panel Installation

---

---

### 3.1 Electrical Specifications

---

**Table 3-1 Electrical Specifications**

Primary AC	120 Vrms at 60 Hz, 2A
Total DC Load	5A
Accessory Power	18.4 V to 27.6 V max., 1A
Smoke Power	18.4 V to 27.6 V max., 1A
Battery Charging Voltage	27.3
Battery Charging Current	2.62 A max.
Class B (style A) Circuit Current	60 mA max.
Telephone Minimum Input Sensitivity	45 dB
Good Phone Line Voltage	3 V
Maximum Low Battery Detect	20.4
Minimum Low AC Detect	98
Maximum Watchdog Response Time	4 sec.
Notification Power	1A max. per output (4A total)

### 3.2 Environmental Specifications

---

It is important to protect the 5207 control panel from water. To prevent water damage, the following conditions should be AVOIDED when mounting the units:

- Do not mount directly on exterior walls, especially masonry walls (condensation).
- Do not mount directly on exterior walls below grade (condensation).
- Protect from plumbing leaks.
- Protect from splash caused by sprinkler system inspection ports.
- Do not mount in areas with humidity-generating equipment (such as dryers, production machinery).

When selecting a location to mount the 5207 control panel, the unit should be mounted where it will NOT be exposed to temperatures outside the range of 0°C-49°C (32°F-120°F) or humidity outside the range of 10%-85% at 30°C (86°F) noncondensing.

See also the mounting recommendations in 3.7 for additional environmental specifications.

### 3.3 Wiring Specifications

To avoid induced noise (transfer of electrical energy from one wire to another), keep input wiring isolated from high current output and power wiring. Induced noise can interfere with telephone communication or even cause false alarms. Avoid pulling one multiconductor cable for the entire panel. Instead, separate the wiring as follows:

1/4" spacing must be maintained between each of these circuit types; as well as between power limited and non-power limited circuits.

Input/Output Type	Wiring
High current:	AC power, speaker, and notification devices
Low current:	Annunciator and zone loop wiring
Audio:	Telephone wiring

DO NOT pull wires from different groups through the same conduit. If you must run them together, do so for as short a distance as possible or use shielded cable. Connect the shield to earth ground at the panel only.

For the same reasons, wiring within the cabinet should be routed around the perimeter of the cabinet. It should not cross the printed circuit board where it could induce noise into the sensitive microelectronics or pick up unwanted RF noise from the high speed circuits.

High frequency noise, such as that produced by the inductive reactance of a speaker or bell, can also be reduced by running the wire through ferrite shield beads or by wrapping it around a ferrite toroid. Figure 3-1 provides an example.

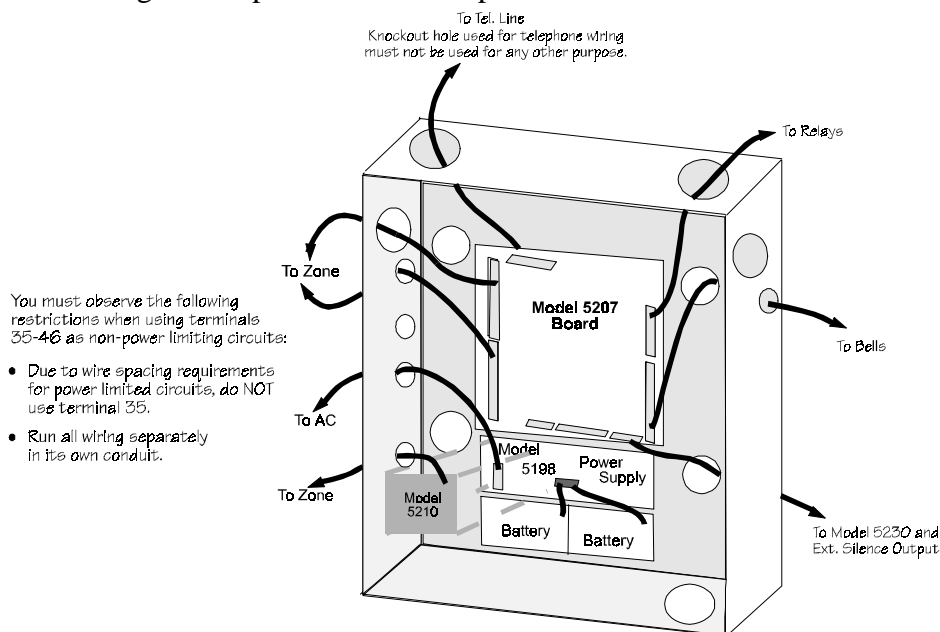

Figure 3-1 Wire Routing Example

### 3.4 Model 5207 Wiring Diagram

Figure 3-2 is a wiring diagram for wiring the Model 5207 panel.

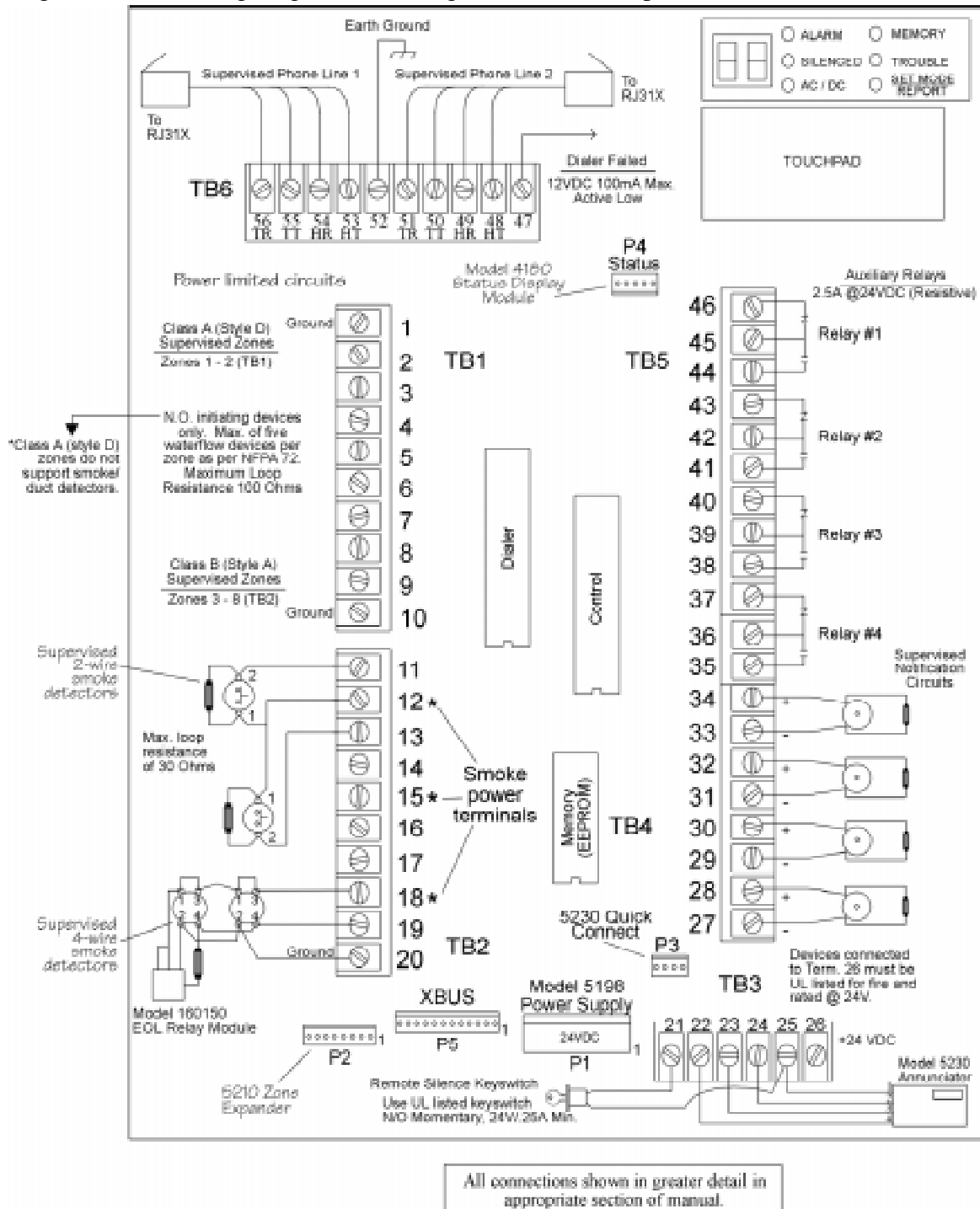

Figure 3-2 Model 5207 Wiring Reference

## 3.5 Current Draw Worksheet

**Table 3-2 Current Draw Worksheet**

Device	Number of Devices	Current per Device	Standby Current	Alarm Current
For each device, use this formula: This column X This column = Current per number of devices.				
5207 Control Panel	1	Standby: 120 mA	120 mA	
		Alarm: 700 mA (worst case)		700 mA
5210 Zone Expander	1	Standby: 40 mA	mA	
		Alarm: 40 mA		mA
5220 Direct Connect	1	Standby: 50 mA	mA	
		Alarm: 50 mA		mA
5230 Annunciator	(7 max.)	Standby: 60 mA	mA	
		Alarm: 120 mA		mA
4180 Status Display	(2 max.)	Standby: 20 mA	mA	
		Alarm: 140 mA		mA
<b>Current Subtotals:</b>			mA	mA
<b>Smoke Detectors</b>	Refer to device manual for current ratings. See Appendix A for compatible devices.			
		Standby: mA	mA	
		Alarm: mA		mA
		Standby: mA	mA	
		Alarm: mA		mA
		Standby: mA		
		Alarm: mA		mA
<b>Current Subtotal:</b>			mA	mA
<b>Notification Appliances</b>	Refer to device manual for current ratings. See Appendix A for compatible devices.			
				mA
				mA
				mA
				mA
<b>Current Subtotal:</b>				mA
<b>Additional Devices</b>				
		Standby: mA	mA	
		Alarm: mA		mA
		Standby: mA	mA	
		Alarm: mA		mA
		Standby: mA	mA	
		Alarm: mA		mA
<b>Current Subtotal:</b>			mA	mA
Total current ratings of all devices in system (add A-D):			mA	mA
Total current ratings converted to amperes (x .001):			A	A

Note: Use this information in conjunction with Table 3-3 and Table 3-4 to complete battery calculations.

### 3.5.1 Worksheet Example

The Current Draw worksheet is included to help you calculate the amount of current the system draws on standby and in an alarm condition. Refer to Table 3-4 for available battery sizes and the maximum standby current load each can support.

Figure 3-3 is an example of a completed worksheet.

List the number of devices being used. The maximum number is shown in parentheses. The number "1" printed in this column indicates that only one device can be used.

For devices with different standby and alarm currents, be sure to do the calculation for each rating.

Fill in missing current ratings for the devices used. Note that some devices have different ratings for standby and alarm conditions.

For each device, use this formula:  $\text{This column} \times \text{This column} = \text{Current per number of devices}$

Do not write in shaded areas.

Cross out entire row of any devices not used.

Write in smoke detectors, notification appliances, etc.

A

B

E

Device	Number of Devices	Current per Device	Standby Current	Alarm Current
<i>For each device, use this formula: This column X This column = Current per number of devices</i>				
5207 Control Panel	1	Standby: 120 mA	120 mA	
		Alarm: 700 mA (worst case)		700 mA
5210 Zone Expander	1	Standby: 40 mA	40 mA	
		Alarm: 40 mA		40 mA
<del>5220 Direct Connect module</del>		<del>Standby: 50 mA</del>	<del>mA</del>	<del>mA</del>
		<del>Alarm: 50 mA</del>		<del>mA</del>
5230 Remote Annunciator	3 (7 max.)	Standby: 60 mA	180 mA	
		Alarm: 120 mA		360 mA
<del>4180 Status Display module</del>		<del>Standby: 20 mA</del>	<del>mA</del>	<del>mA</del>
	<del>(2 max.)</del>	<del>Alarm: 140 mA</del>		<del>mA</del>
<b>Current Subtotals:</b>			340 mA	1100 mA
<b>Smoke Detectors</b> <i>Refer to device manual for current ratings. See Tables 6-2 and 6-3 for max. # per loop</i>				
Model XYZ	16	Standby: 1.50 mA	24 mA	
		Alarm: 62.5 mA		1000 mA
		Standby: mA	mA	
		Alarm: mA		mA
		Standby: mA	mA	
		Alarm: mA		mA
<b>Current Subtotals:</b>			24 mA	1000 mA
<b>Notification Devices</b> <i>Refer to device manual for current ratings.</i>				
Model ABC	16	Alarm: 179.7 mA		2875 mA
<b>Total current ratings of all devices in system (add A-D)*:</b>			389 mA	4875 mA
<b>Total current ratings converted to amperes (x .001):</b>			0.389 mA	4.875 mA

For row E, add the subtotals from rows A-D and multiply by .001.

Figure 3-3 Current Draw Worksheet Example

### 3.5.2 Worksheet Requirements

The following steps must be taken when determining Model 5207 current ratings:

1. Measure the alarm current. If only one current rating is listed, the draw for that device is the same whether the system is in alarm or standby condition. The exception is for notification devices, which are rated at alarm current only. Standby current for notification devices is 0 mA.
2. To detect the actual maximum alarm current, measure the current draw (with no devices connected to the panel) by connecting a DC amp meter in series with one of the batteries. Disconnect the AC power source. Put the panel in alarm. The meter will indicate the alarm current, which will be in the range of 120-700 mA. Fill in the system alarm current in the Current per Device column of the Current Draw worksheet. You can estimate without measuring the alarm current by filling in the maximum total alarm current of 700 mA.
3. For smoke detectors, notification devices, and devices not mentioned in the manual, refer to the device manual for the current ratings. The worksheet example shown on the previous page provides rough estimates for a “worst case” installation.
4. Use Table 3-3 to calculate the correct battery AH rating needed for your installation. See also the example (Figure 3-4) on the next page. Note that the calculated rating in Row H cannot exceed the ratings shown in Table 3-4.

**Table 3-3 Battery Calculations**

		Total Standby Current	Total Alarm Current
A	Total supervisory current from the Current Draw Worksheet (row E).	A	
B	Number of standby hours (24 and 60 for NFPA 72, Chapter 1, 1-5.2.5).	H	
C	Multiply Lines A and B.	AH	
D	Total alarm current from the Current Draw worksheet (row E).		A
E	Alarm sounding period in hours. (For example, 5 minutes = .084 hours.)		H
F	Multiply lines D and E.		AH
G	Add lines C and F.	AH	
H	Multiply line G by 1.2. (Total ampere/hours required*)	AH	

\*Use next size battery with capacity greater than required.



This calculation is based on the Current Draw worksheet example data.  
From this table, the installer would use a 17 AH battery

		Total Standby Current	Total Alarm Current
A	Total supervisory current from the Current Draw worksheet (row E).	0.389 A	
B	Number of standby hours (24 and 60 for NFPA 72, Chapter 1, 1-5.2.5.).	24 H	
C	Multiply lines A and B.	9.34 AH	
D	Total alarm current from the Current Draw worksheet (row E).		4.875 A
E	Alarm sounding period in hours. (For example, 5 minutes = .084 hours.)		.084 H
F	Multiply lines D and E.		.41 AH
G	Add lines C and F.	9.75 AH	
H	Multiply line G by 1.2. (Total ampere/hours required*)	11.7 AH	

**Figure 3-4 Battery Calculation Example**

- Refer to to verify the battery size you need to provide at least the total standby current you have calculated. If the installation must meet requirements for NFPA 72 (Auxiliary Protected Fire Alarm Systems for Fire Alarm Service or Remote Station Protected Fire Alarm Systems, Digital Communication or Polarity Reversal), the total standby current cannot exceed the amount shown in the last column of the following table:

**Table 3-4 Maximum Battery Standby Load**

Rechargeable Battery Size	Max. Load for 24 hrs. Standby, 5 mins. Alarm	*Max. Load for 60 hrs. Standby, 5 mins. Alarm
17 AH	435 mA	175 mA
34 AH (if wired in parallel) (Largest size battery that can be used.)	873 mA	350 mA
* Required for NFPA 72 Auxiliary Protected Fire Alarm Systems for Fire Service (City Box) and Remote Station Protected Fire Alarm Systems (Polarity Reversal).		

- Ensure that the total current of all items attached to the 5207, including the 5207 itself, does not exceed 5 A when the panel is in alarm (see Section 3.1).

## 3.6 Power Supply Wiring

The Model 5198 power supply delivers 24 VDC at 5A for loop power, smoke detector power, notification device power, and accessory power. The Model 6914 is a 12-Volt, 17-AH battery. Figure 3-5 shows the power supply wiring.

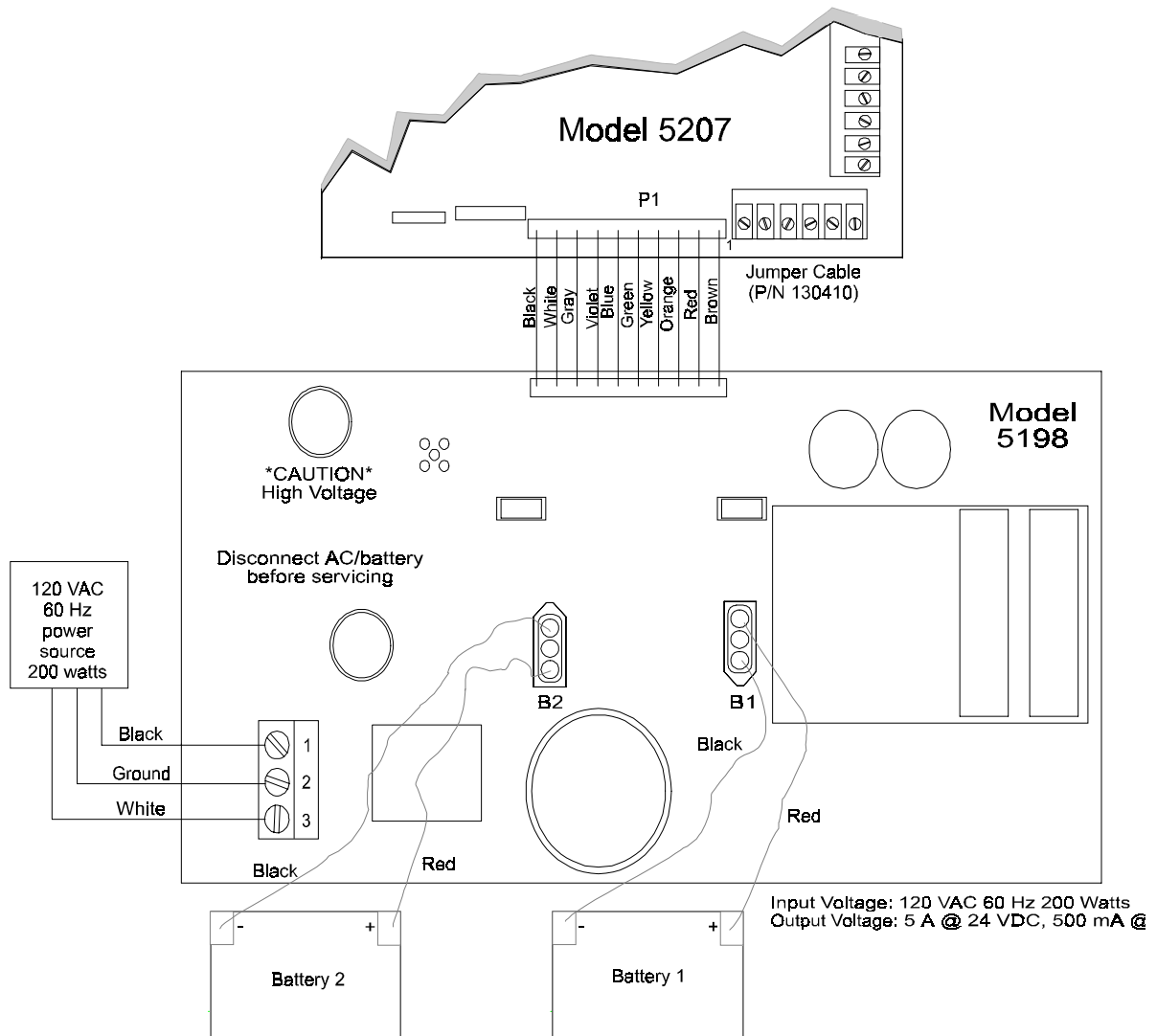

Figure 3-5 Power Supply Wiring

### Warning

To reduce the risk of electrical shock, make sure that all power has been turned off or disconnected before attempting to connect the Model 5198 power supply. Do NOT apply power to this panel until all accessories are properly connected.

*Note: All conduit and wiring connected to the 5207 must meet the applicable National Electric Code, NFPA Standards, state, and local building code requirements. In all cases, the authority having jurisdiction takes precedence.*

### 3.6.1 Connecting the 5198 to AC Power

The Model 5198 is mounted behind the power shield.

- Connect the **black** wire from the 120 VAC 60 Hz source to terminal 1 on the 5198.
- Connect the **white** (neutral) wire from the 120 VAC 60 Hz AC source to terminal 3 on the 5198.
- Connect the **ground** wire from the 120 VAC 60 Hz source to terminal 2 on the 5198.

### 3.6.2 Connecting the 5198 to Batteries

The tables in Section 4 will help you determine correct battery size.

#### Caution

Apply AC power before connecting the batteries to the power supply to prevent arcing on battery terminals.

*When using two batteries, it is recommended that they be of the same ampere hour (AH) rating.*

The Model 5198 provides two sets of battery leads to connect two 12 VDC batteries in series.

1. Connect the first **red** battery lead to the **positive** side of battery #1.
2. Connect the first **black** battery lead to the **negative** side of battery #1.
3. Connect the second **red** battery lead to the **positive** side of battery #2.
4. Connect the second **black** battery lead to the **negative** side of battery #2.

*Note: The total current draw on loop power, accessory power, and notification device outputs must not exceed 6A.*

## 3.7 Mounting the 5207

---

Read the environmental specifications in 3.2 before mounting the 5207 panel.

The 5207 cabinet dimensions are: 16"x 26.4" x 4" (HxWxD).

The 5207 panel should be located within a secured area, where it is accessible to main drop wiring runs and where it can be easily tested and serviced. End-users responsible for maintaining the panel should be able to hear alarms and troubles. When selecting a location, keep in mind that the panel itself is the main source of alarm and trouble annunciation.

When mounting on interior walls, use appropriate screw anchors in plaster. When mounting on concrete, especially when moisture is expected, attach a piece of 3/4 inch plywood to the concrete surface and then attach the 5207 to the plywood. Also mount any other desired components to the plywood.

DO NOT flush-mount the 5207 cabinet in a wall designated as a fire break.

## 3.8 Terminal Strip Description

The terminal strips on the PC board are nonremovable. Table 3-5 on the next page lists the function and electrical rating of each terminal. See Section 3.4 for the wiring diagram.

**Table 3-5 Terminal Strip Description**

Terminal #	Terminal Description	Electrical Ratings
<b>TB1</b>		
1	Circuit Ground	
2	Zone 1 input (class A, style D) Loop A Out	
3	Zone 1 input (class A, style D) Loop B Out	
4	Zone 1 input (class A, style D) Loop B In	
5	Zone 1 input (class A, style D) Loop A In	
6	Zone 2 input (class A, style D) Loop A Out	
7	Zone 2 input (class A, style D) Loop B Out	
8	Zone 2 input (class A, style D) Loop B In	
9	Zone 2 input (class A, style D) Loop A In	
10	Circuit Ground	
<b>TB2</b>		
11	Zone 3 Input (class B, style A)	
12	Loop Power Output	24 VDC
13	Zone 4 Input (class B, style A)	
14	Zone 5 Input (class B, style A)	
15	Loop Power Output	24 VDC
16	Zone 6 Input (class B, style A)	
17	Zone 7 Input (class B, style A)	
18	Loop Power Output	24 VDC
19	Zone 8 Input (class B, style A)	
20	Circuit Ground	
<b>TB3</b>		
21	Remote Silence	
22	Annunciator Output	
23	Annunciator Input	
24	Annunciator Power Output	+12 VDC nominal
25	Annunciator Ground	
26	Accessory Power	+24 VDC
<b>TB4</b>	Note: Outputs can also be used for polarity reversing outputs (polarity shown active).	
27	Notification device output #4 Negative	1 amp max.
28	Notification device output #4 Positive	
29	Notification device output #3 Negative	1 amp max.
30	Notification device output #3 Positive	

Table 3-5 Terminal Strip Description

Terminal #	Terminal Description	Electrical Ratings
31	Notification device output #2 Negative	1 amp max.
32	Notification device output #2 Positive	
33	Notification device output #1 Negative	1 amp max.
34	Notification device output #1 Positive	
35	Auxiliary Relay #4 Normally Open Contact	2.5 amp max.
36	Auxiliary Relay #4 Common	
<b>TB5</b>		
37	Auxiliary Relay #4 Normally Closed Contact	2.5 amp max.
38	Auxiliary Relay #3 Normally Open Contact	2.5 amp max.
39	Auxiliary Relay #3 Common	
40	Auxiliary Relay #3 Normally Closed Contact	2.5 amp max.
41	Auxiliary Relay #2 Normally Open Contact	2.5 amp max.
42	Auxiliary Relay #2 Common	
43	Auxiliary Relay #2 Normally Closed Contact	2.5 amp max.
44	Auxiliary Relay #1 Normally Open Contact	2.5 amp max.
45	Auxiliary Relay #1 Common	
46	Auxiliary Relay #1 Normally Closed Contact	2.5 amp max.
<b>TB6</b>		
47	Dialer Failed Output (Active Low)	100 mA, 12 VDC max.
48	House Phone 2 Tip	
49	House Phone 2 Ring	
50	Telco 2 Tip	
51	Telco 2 Ring	
52	Earth Ground	
53	House Phone 1 Tip	
54	House Phone 1 Ring	
55	Telco 1 Tip	
56	Telco 1 Ring	

## 3.9 Telephone Line Connection

The 5207 connects to two separate telephone lines to report data to the central station. An RJ31X jack should be installed by the telephone company for each line. Figure 3-6 shows how to wire the telephone line interconnect cords (not provided) to the 5207.

*Note: To reduce the possibility of false alarms and transient damage, DO NOT bundle telephone wires together with notification device wires.*

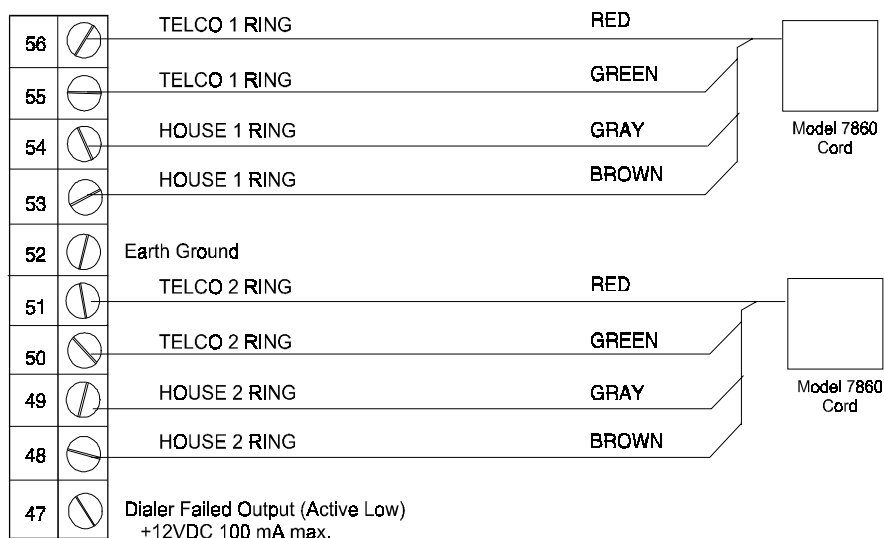

**Figure 3-6 Telephone Line Connection**

The 5207 has built-in dual phone line monitors. These circuits will detect any fault in the phone lines by monitoring the DC voltage present on the lines. If phone line voltage drops below 3 VDC and is not corrected within approximately 40 seconds, an audible trouble signal will sound and the panel will report a line fault trouble over the remaining phone line.

A situation could occur where both phone lines appear to be good, but the dialer cannot get through to the central station on the first line. In this case, the 5207 will switch phone lines and attempt the call again using the second line. Make sure the phone lines are programmed properly (see Section 7).

***Notice:** To comply with industry standards, this product is equipped with line seizure. Any time the system's dialer needs to communicate with the central station, it will not be possible to use any telephones that are on the same line(s) as the system. Normally, this condition will last approximately one minute, but under adverse telephone circuit conditions, could last for as long as 15 minutes.*

## 3.10 Cable Connectors

---

### **Power Supply Connector (P1)**

Connects the 5207 control panel to the 5198 power supply.

### **Model 5210 (P2)**

Connects the 5210 zone expander to the 5207.

### **Quick Connect (P3)**

For temporarily connecting a 5230 for programming or troubleshooting. Requires cable assembly 130294 (not included).

### **Status (P4)**

Connects the 4180 display module to the 5207.

### **XBUS Connector (P5)**

A 12-pin connector used to connect the 5221 Desktop Programmer (no longer manufactured).





# Section 4

## Compatible Product Installation

This manual refers to fire zone types using the latest NFPA standard designations. Refer to the *NFPA 72 National Fire Alarm Code, 1993 Edition* for additional information.

*Note: For purposes of this manual, a normally open device's contacts conduct when in an alarm state and do not conduct in a non-alarm state.*

### 4.1 Class A (Style D) Zones

Zones 1 and 2 are class A (style D) zones. They are intended for use with non-powered devices such as waterflow switches. Do NOT use smoke or duct detectors on Class A zones.

Each class A zone is a four-wire circuit that allows an alarm to be detected even after a single open or ground fault occurs. When a single open or ground fault occurs, the audible trouble signal will sound and the 5207 will report the trouble to the central station (if programmed to report troubles).

Figure 4-1 shows how to wire a class A (style D) loop. No end-of-line (EOL) resistors are needed for these zones. These zones must be wired using normally open contacts.

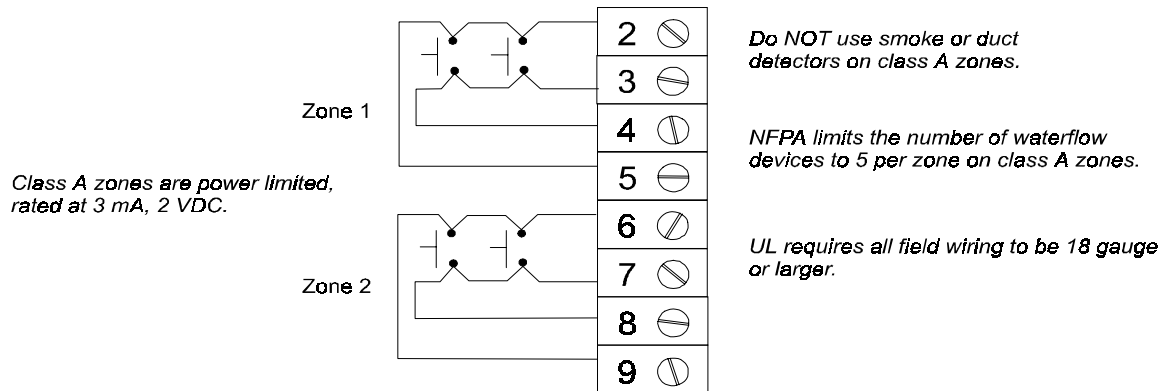
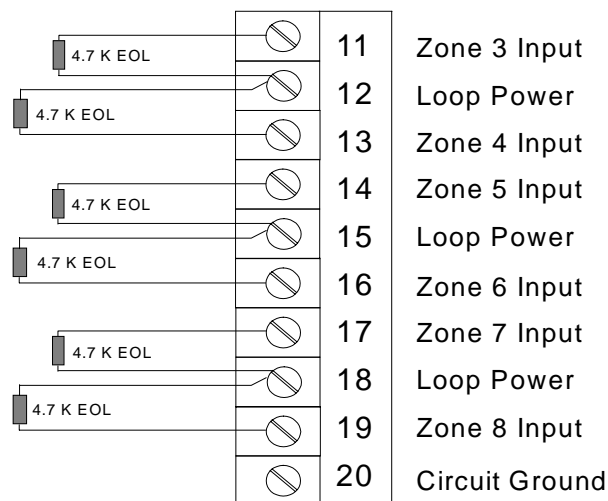

**Figure 4-1 Class A (style D) Supervised Fire Loop (Normally Open Sensors Only)**

## 4.2 Class B (Style A) Zones

Zones 3 through 8 are class B (style A) fire zones. Each class B zone consists of a two-wire circuit that will detect the occurrence of an open in the loop, but may not be able to detect an alarm after such an occurrence. The detection of an open will cause the audible trouble signal to sound and the 5207 will report the trouble to the central station (if programmed to do so).

Figure 4-2 shows how to wire a class B (style A) loop. One side of each class B loop connects to a zone input terminal and the other side of each loop connects to loop power. For each loop, use a 4.7K-ohm EOL resistor wired in parallel with the normally open contact farthest from the panel.



**Figure 4-2 Model 5207 Class B (style A) Loops**

Maximum Loop Resistance - 30 ohms

Maximum Total alarm current for all class B (style A) zones - 1 A

Maximum Standby Current per Zone:

24V system - 2.0 mA

*Note: UL requires all wiring to be at least 18 gauge.*

## 4.3 Four-Wire Smoke Detector Connection

Figure 4-3 illustrates how UL listed four-wire smoke detectors must be connected to class B (style A) zones.

When wiring a four-wire smoke detector to the class B (style A) zones, you must use a Power Supervision Unit, such as Silent Knight's 160150.

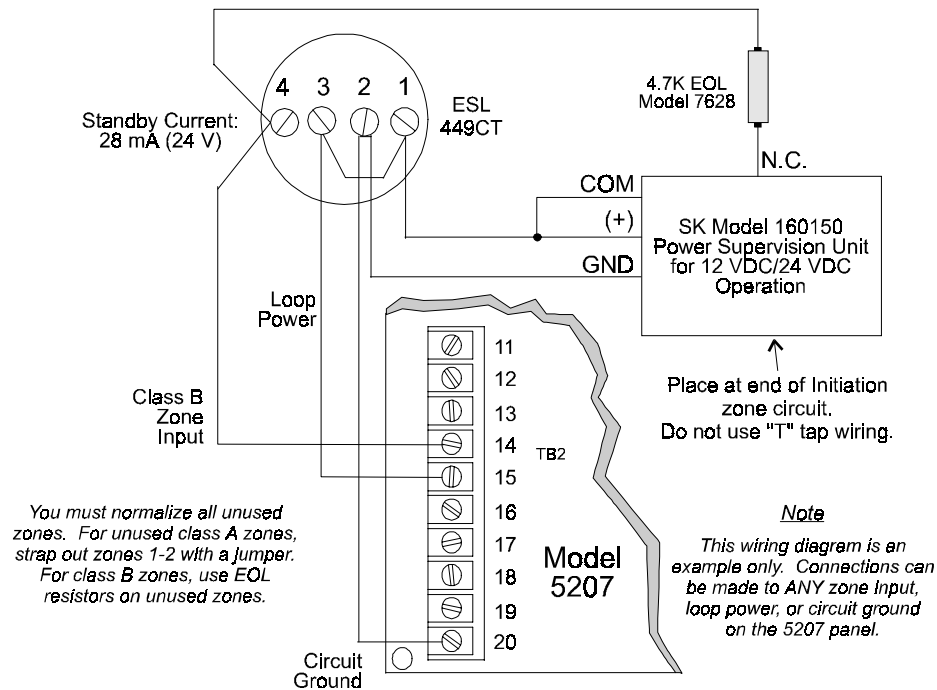

**Figure 4-3 Four-Wire Smoke Detector Wiring**

See Appendix A for a list of four-wire smoke detectors that may be used with the 5207.

## 4.4 Two-Wire Smoke Detector Connection

Figure 4-4 shows how to connect two-wire smoke detectors to class B (style A) zones.

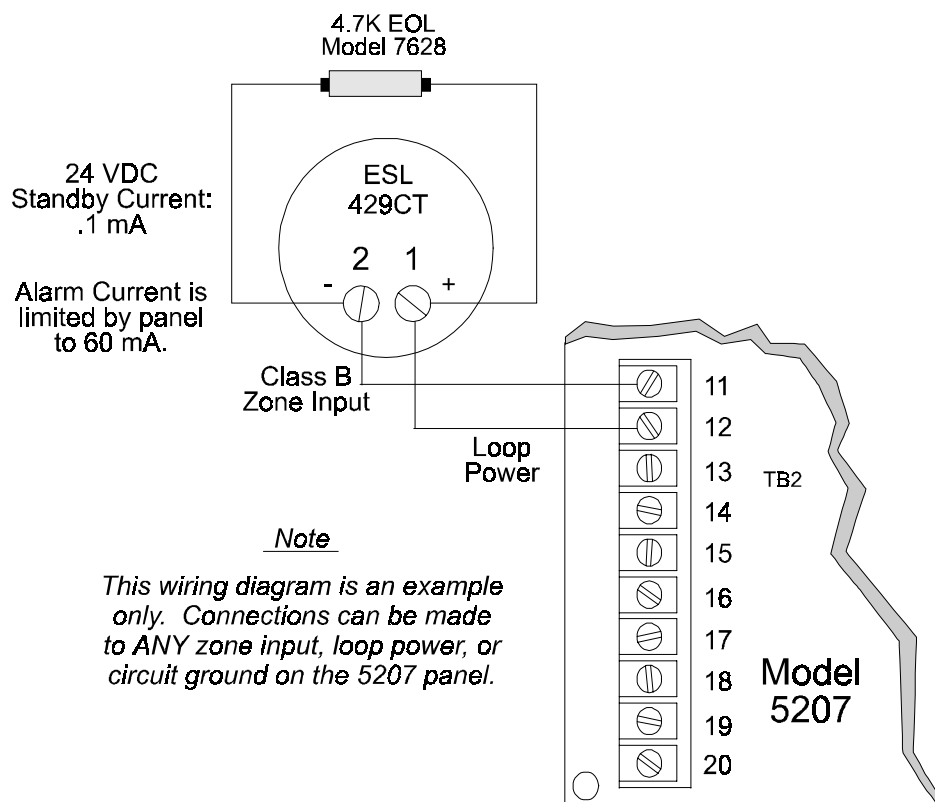

Figure 4-4 Two-Wire Smoke Detector Wiring

See Appendix A for a list of two-wire smoke detectors that may be used with the 5207.

## 4.5 Model 4180 Status Display Module

The Model 4180 Status Display module provides remote annunciation of alarm and trouble status information for each zone.

The 4180 has 2 connectors, each of which has 8 outputs available for annunciation. These outputs are active high at +12 VDC. Each output can provide up to 100 mA of current, with a total limitation of 700 mA. The module has 4 normally open non-dedicated relays that can be wired to be active with any of the outputs. The 4180 is not supervised.

Wire the 4180 as shown in Figure 4-5. Make sure power is OFF at the panel before plugging in the 4180. Maintain a physical separation of one-half inch or more between field wires and connection points to prevent damage from transients.

*Note: SILENCE does not affect 4180 outputs. To reset a 4180 output, the alarm or trouble condition must be restored and event memory cleared.*

The 4180 can be used to interface to long-range RF systems.

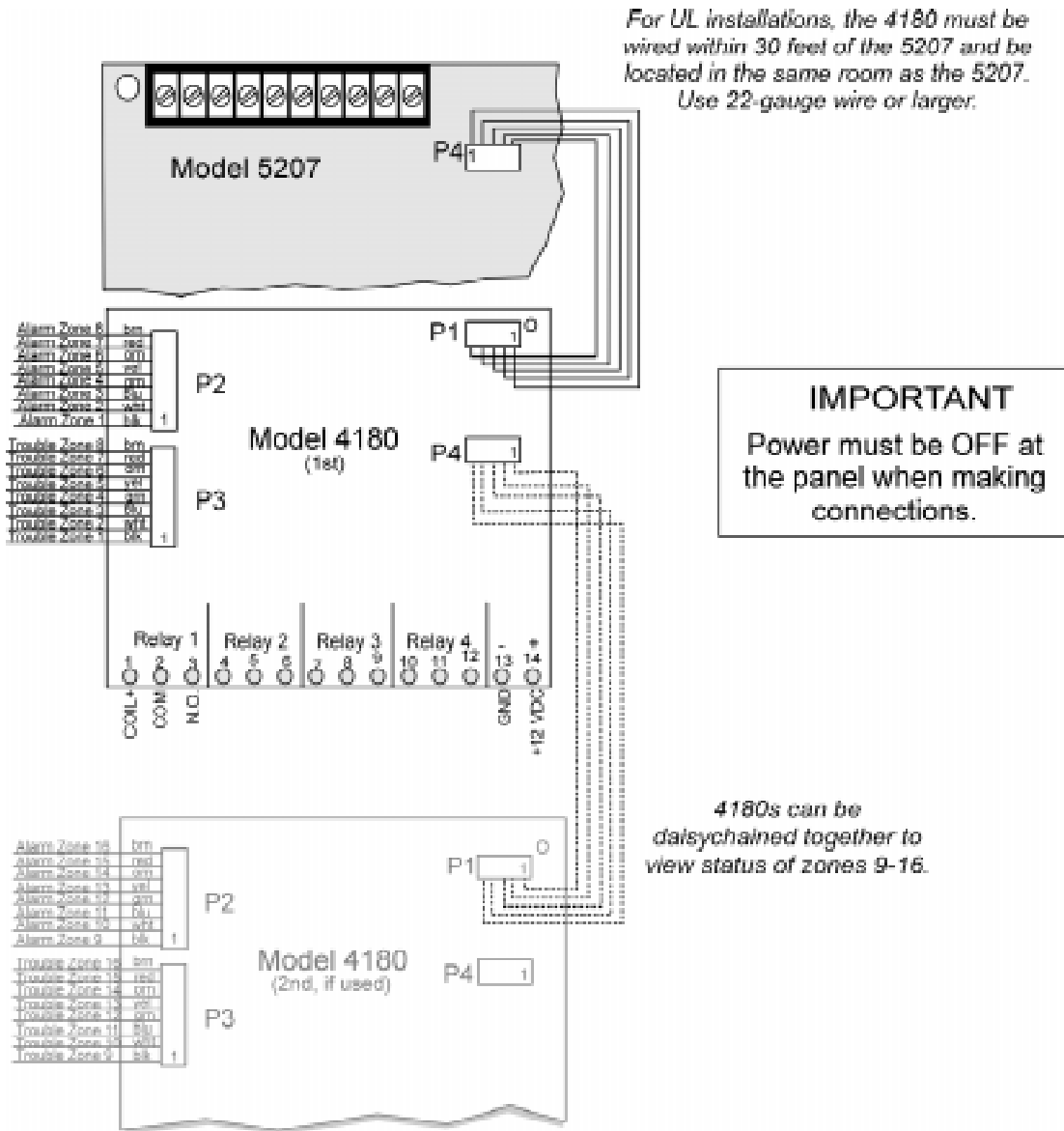

Figure 4-5 Model 4180 Connection

## 4.6 Model 5210 Zone Expander Wiring

The Model 5210 provides the 5207 with eight additional class B (style A) zones. Figure 4-6 shows how to wire the 5210. Use a 4.7k end of line resistor for each class B loop. The EOL must be wired in parallel with the normally open contact farthest from the panel. See Appendix A for a list of the smoke detectors that can be used with the 5210.

Maximum Loop Resistance - 30 ohms

Maximum Total Alarm current (powered from loop power) for all class B (style A) zones - 1 A

Maximum Standby Current Per Zone - 1 mA

Voltage ranges:

- When used with the 5207 - 24 VDC (Model 5210 Identifier 24A): 17.8 VDC - 27.4 VDC

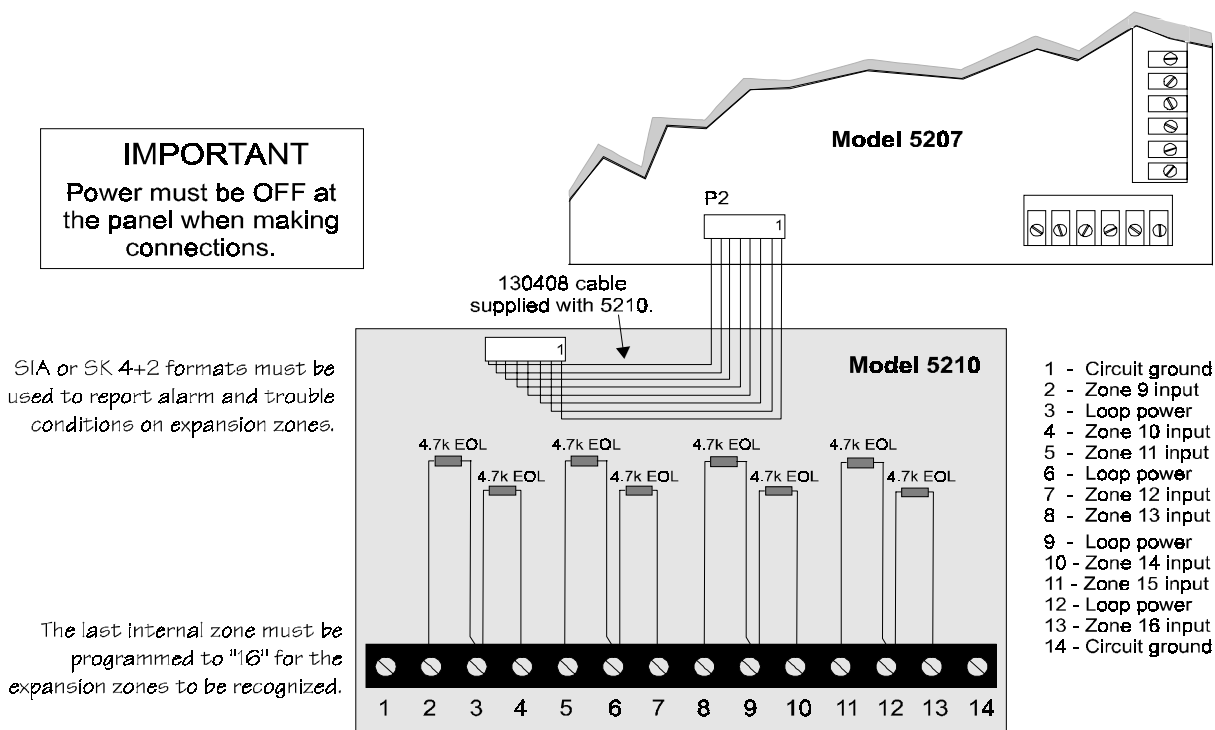

Figure 4-6 Model 5210 Style A Loops

### Installation Instructions

The 5210 is equipped with a metal bracket. To install, fit the bracket over the 5198 power supply unit in the 5207 cabinet. With panel power OFF, use the cable provided to connect the 5210 to its connector (P2) on the 5207. Insert screws provided. Place the four plastic stand-offs into the bracket and snap onto the PC board. Then plug the 8-pin cable from the PC board into the P2 connector on the 5207.

## 4.7 Model 5220 Direct Connect Module

The 5220 Direct Connect module can be used with the 5207 to meet NFPA 72 standards. The 5220 requires four connections to the 5207 and provides outputs for city box and polarity reversal applications. The 5220 cannot be used for sprinkler supervisory.

The 5220 provides a current that reverses polarity during alarm or removes current during a trouble condition.

### 4.7.1 City Box Connection

This section describes how to connect the 5207 to a municipal fire alarm box or "city box" as required by NFPA 72 Auxiliary Protected Fire Alarm systems for fire alarm service. The city (master) box is an enclosure that contains a manually operated transmitter used to send an alarm to the municipal communication center which houses the central operating part of the fire alarm system.

The maximum coil and wire resistance (combined) must not exceed 30 ohms.

To install the 5220 for city box connection:

1. Locate the knockout on the right side of the 5207 cabinet to connect the 5220 using a short piece of conduit (must not exceed 20 feet in length).
2. Wire the 5220 to the 5207 as shown in Figure 4-7. This drawing also shows how to connect the city box coil to terminals 3 and 4 on the 5220.
3. Select notification circuit #4 to be supervised (Step 5), but do not install an EOL resistor in the notification circuit terminals. Do not select pulsing fire bells.

It is not possible to reset the remote indication until you clear the condition and reset the 5207.

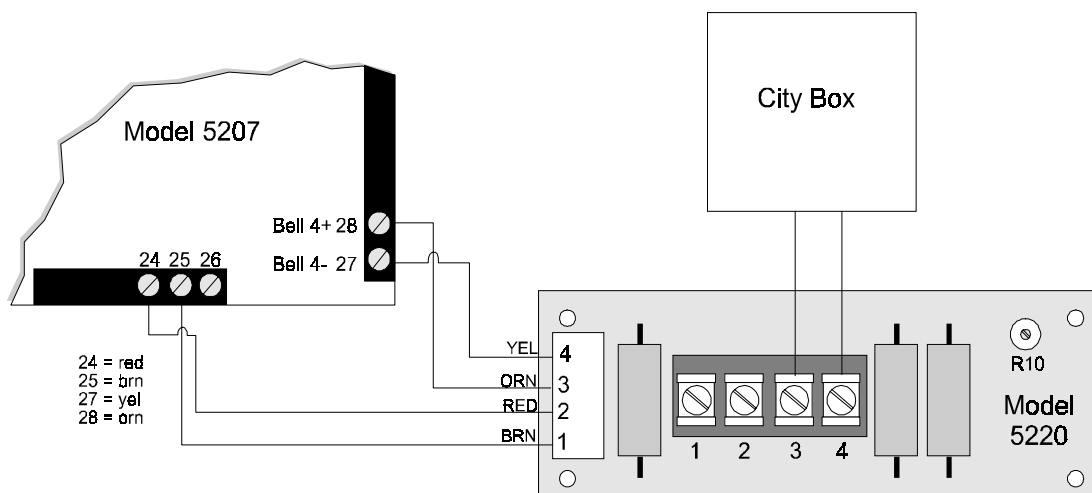

Figure 4-7 City Box Connection

## 4.7.2 NFPA 72 Polarity Reversal

When the 5220 is wired and programmed for polarity reversal, it reports alarm and trouble events to a remote site. Alarms will override trouble conditions and it will not be possible to reset the remote indicator until the condition is cleared and the 5207 panel is reset.

If an alarm condition occurs, the alarm relay will close, overriding the trouble condition.

To install the 5220 for polarity reversal, follow the steps below:

1. Locate the knockout on the right side of the 5207 cabinet to connect the 5220 using a short piece of conduit (must not exceed 20 feet in length).
2. Wire the 5220 to the 5207 using the four-wire pigtail provided as shown in Figure 4-8 (next page). This diagram also shows how to connect the 5220 to the remote indicator.
3. Program relays as shown in the chart below:

<u>Step</u>	<u>Option</u>	<u>Select</u>
23.4	Fire Alarm	Relay 2
23.5	Trouble	Relay 3
23.6	No Silence	Relay 3 and Bell 4

4. Program notification circuit 4 to be non-supervised (Step 5) and non-silencing (Step 23.6, Bell #4). Do not select pulsing bells.
5. If necessary, adjust loop current using potentiometer R10 on the 5220 board. Normal loop current is 4-to-8 mA with a 1k ohm remote station receiving unit. Maximum loop resistance is 3k ohm.

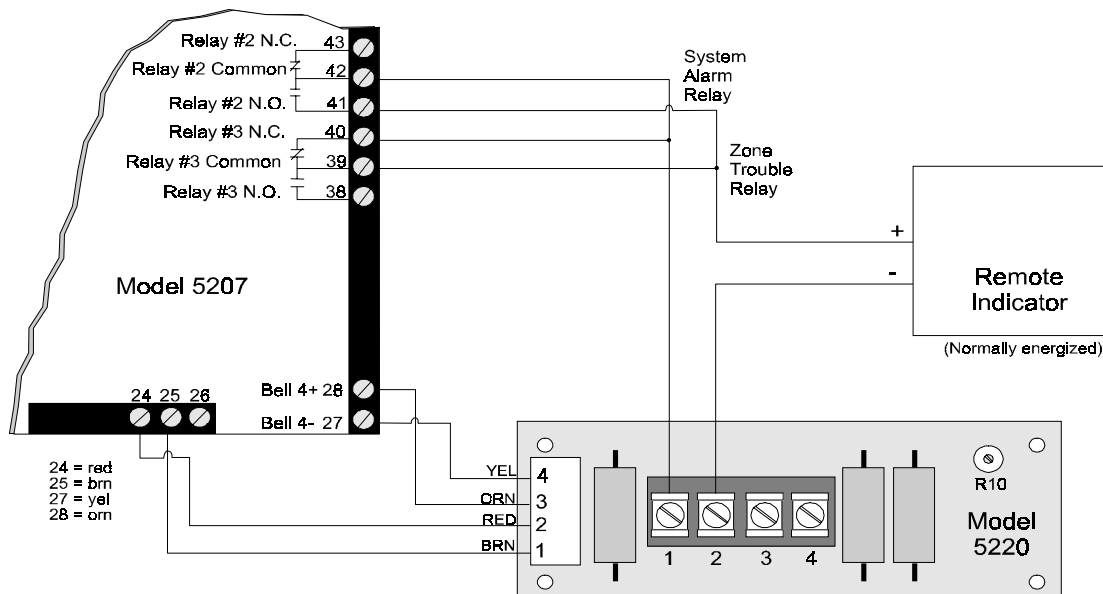

Figure 4-8 Polarity Reversal Connection



## 4.8 Keltron 95M3158 Tones Transmitter Module

This section of the manual shows the specific connections you will make when wiring the 5207 to the Keltron 95M3158 Tones Transmitter Module (3158). Refer to the installation sheet shipped with the 95M3158 for complete information. (Note: The 3158 is not available from Silent Knight.)

*Note: The 3158 Keltron Module must be mounted within 3 feet of the control panel and all wiring must be run in conduit. The Keltron Module shall be enclosed in the TBX1 enclosure.*

1. Wire the 3158 to the 5207 as shown in the figure below.
2. Program Relay 3 to activate for all trouble conditions and no silence. Relay 2 should be programmed to activate for Alarms.
3. Program notification circuit 3 and 4 to be non-supervised and non-silencing.
4. Program Bell 3 as “Special”.

The chart below shows which selections to make in step programming.

Step	Option	Select	De-select
5	Misc Opts		Bell 3 and Bell 4
23.3	Special	Bell 3	
23.4	Fire Alarm	Relay 2	Bell 3
23.5	Trouble	Relay 3	
23.6	No Silence	Relay 3, Bell 3 and Bell 4	

*Note: DO NOT select pulsing bells.*

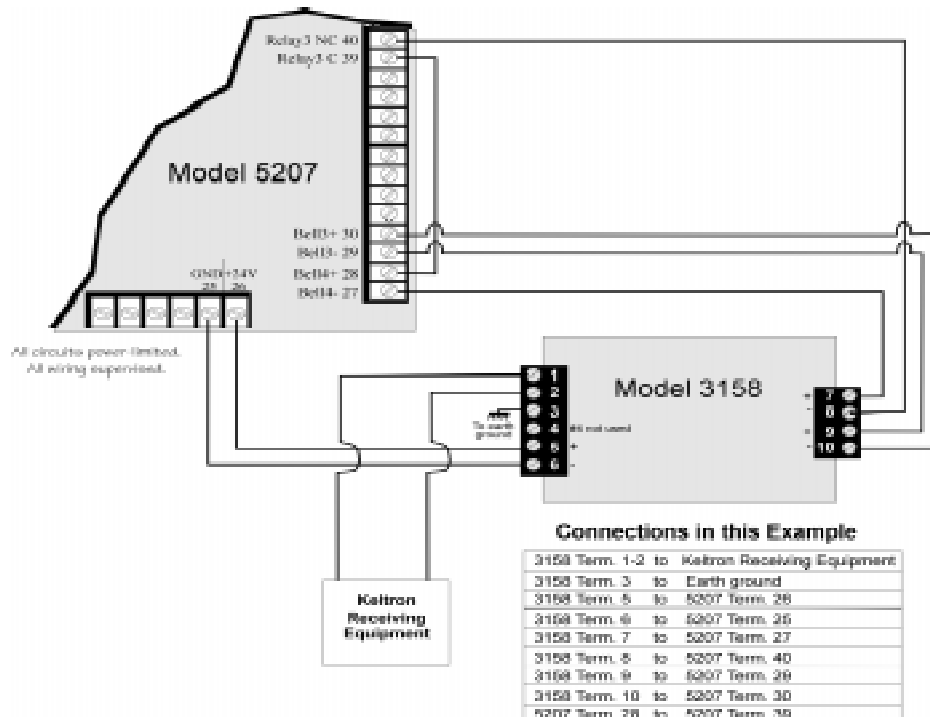

Figure 4-9 Wiring the Keltron 3158 to the 5207

## 4.9 Model 5230 Remote Annunciator

The 5230 performs all system operation. It also provides trouble and alarm information and can be used for programming.

### 4.9.1 Setting ID Codes

Before permanently installing the Model 5230 Remote Annunciator, you must first set its identification codes. Each annunciator to be supervised must be given its own identification codes. The ID numbers must start at 1 and progress sequentially to 7 (7 annunciators max.). Upon initial power up, the address of each annunciator is displayed. (Annunciators with address 0 will not be supervised.)

On the back of each annunciator is a small 4-position dip switch used to set the ID code. Use the chart below to determine the dip switch positions for each possible ID code.

**Table 1-1: Model 5230 Dip Switch Settings**

ID Number	Switches			
	1	2	3	4
0 *	Up	Up	Up	Up
1	Down	Up	Up	Up
2	Up	Down	Up	Up
3	Down	Down	Up	Up
4	Up	Up	Down	Up
5	Down	Up	Down	Up
6	Up	Down	Down	Up
7	Down	Down	Down	Up

\*Not supervised    Up = On    Down = Off

## 4.9.2 5230 Permanent Connection

Wire permanent 5230s as shown in Figure 4-10. When the annunciator powers up, it will display its ID code and current status of the panel.

A temporary 5230 can be connected for programming and troubleshooting. See Section 4.9.4 for temporary annunciator connection.

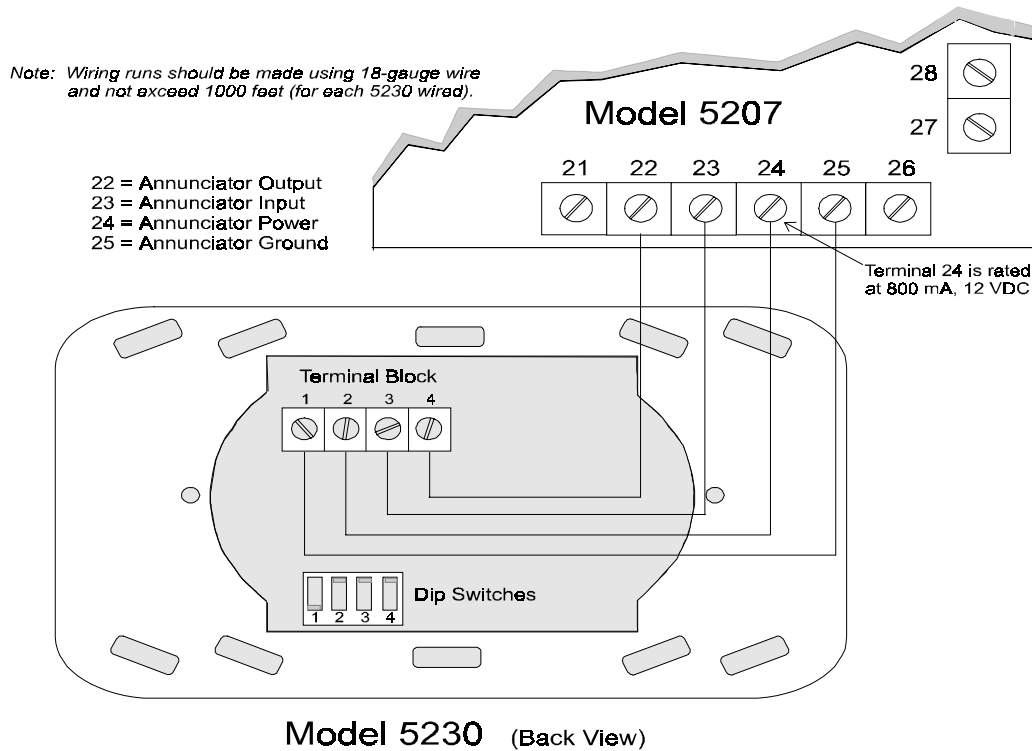

Figure 4-10 Model 5230 Connection

### 4.9.3 Mounting the 5230 Remote Annunciator

For UL installations, the 5230 Remote Annunciators must be mounted on a dual gang electrical box and all wiring runs must be made using 18-gauge wire or larger.

To mount the annunciator:

1. Remove the rear mounting plate by inserting a #4 flat blade screwdriver into the slots on the bottom edge of the annunciator. Gently turn the screwdriver until the mounting plate pulls away from the frame.
2. Secure it to the wall using #6 or #8 screws. The mounting plate should be oriented so that the word TOP is toward the top of the plate and facing you. A square hole is provided in the mounting plate to run the wiring to the annunciator.
3. When all of the wires have been connected to the annunciator, set the top of the annunciator over the tabs on the top of the mounting plate. Make sure the wires do not get pinched between the frame and the mounting plate. Press each corner of the bottom side onto the annunciator mounting plate until you hear it click. You may have to gently squeeze the annunciator (top to bottom) to align it while snapping the bottom edge into place.

### 4.9.4 Temporary Annunciator Connection

If you are using an annunciator for programming or troubleshooting only, you can use cable P/N 130294 (ordered separately) to temporarily attach the 5230 at connector P3. Figure 4-11 shows the connections. A temporary annunciator must have an ID number (1 or higher) but does not need to be enabled through programming.

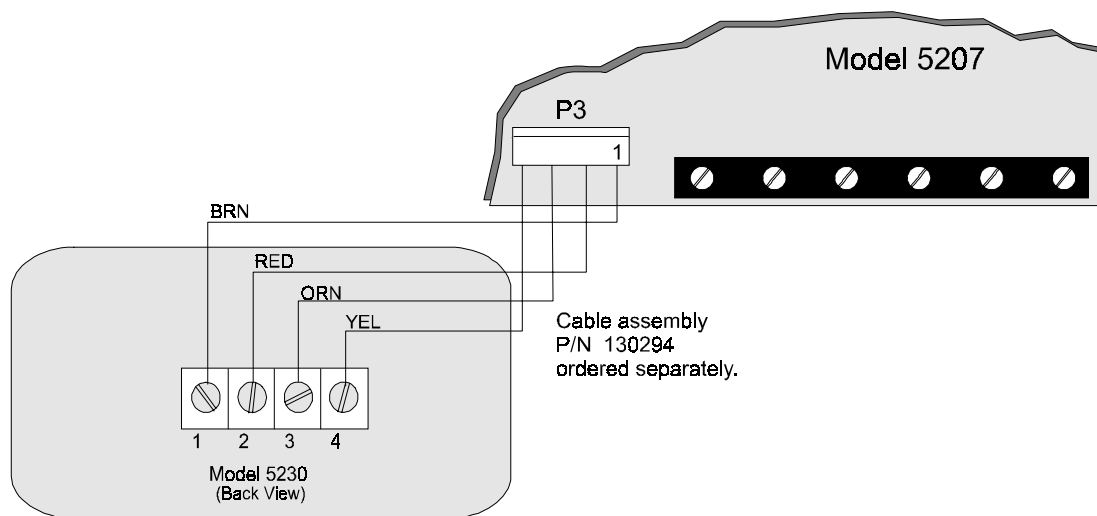

Figure 4-11 Temporary Annunciator Connection

## 4.10 Model 5395 Signal Power Expander

The Model 5395 is a notification and auxiliary power expander that provides up to 6.0 amps of regulated, 24-volt power for powering notification appliances and auxiliary devices.

Figure 4-12 shows you how to connect the Model 5395 to the Model 5207 panel. See the 5395 installation manual (P/N 150933) for complete information.

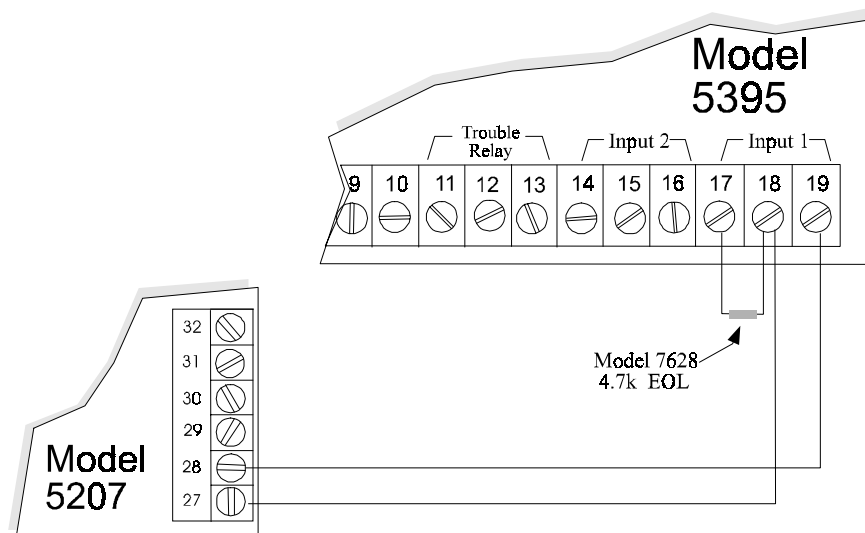

Figure 4-12 5395 Connection to 5207

## 4.11 Model 7181 Zone Converter

The Model 7181 Zone Converter lets you interchange zone types on the 5207. Figure 4-13 and Figure 4-14 show how to make conversions. Refer to the *Model 7181 Installation Manual* (P/N 150632) for complete information.

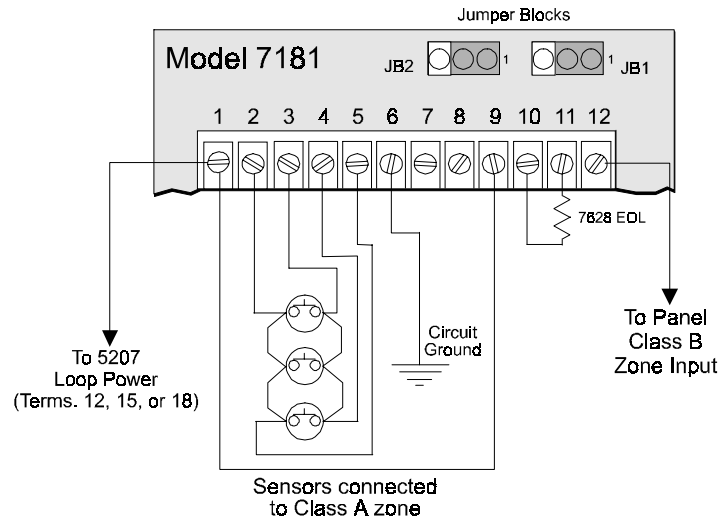

Figure 4-13 Connecting Class A (Style D) Sensor to Class B (Style A) Panel

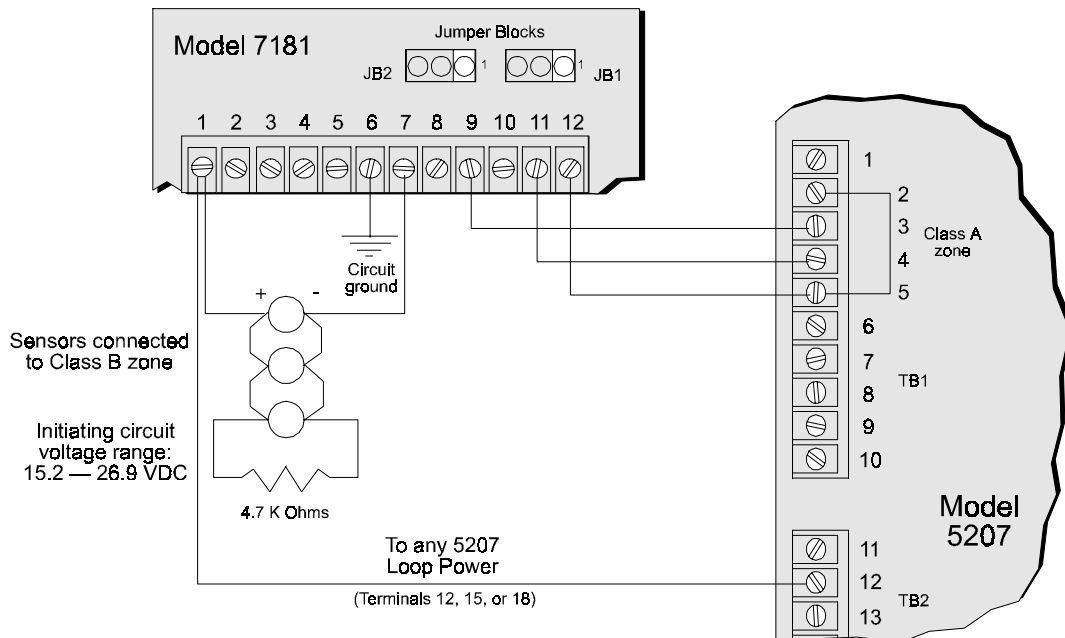
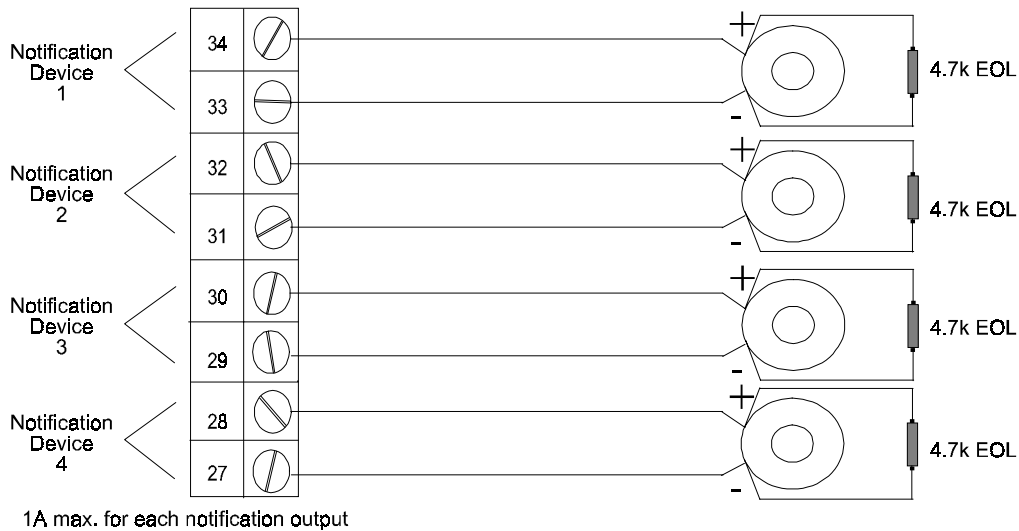

Figure 4-14 Connecting Class B (Style A) Sensor to Class A (Style D) Panel

## 4.12 Supervised Notification Appliance Outputs

*Note: To reduce the possibility of false alarms and transient damage, DO NOT bundle telephone wires together with notification circuit wires.*

The 5207 provides four supervised notification circuit outputs to annunciate alarm conditions. For proper operation, you must use polarized sounding devices with a 4.7k ohm end-of-line resistor on each loop. Figure 4-15 shows how to connect the notification circuits to the 5207.



**Figure 4-15 Supervised Notification Appliance Wiring**

See Appendix A for a list the UL sounding appliances that can be used with the 5207. Contact Silent Knight if you have any questions about compatible notification circuits.

## 4.13 Auxiliary Relays

The 5207 provides four programmable auxiliary relay outputs. Relays can be programmed to activate for the following conditions, either for all zones or by individual zone: pre-alarm (entry delay) (not acceptable for NFPA 72 Central Station), fire alarm, auxiliary alarm, alarm by zone, and system or loop troubles (loss of AC, low battery, failed to communicate, phone line troubles, and notification circuit troubles).

Refer to the 5207 programming manual for more information. Figure 4-16 shows the relay contact connections using a doorstrike application as an example.

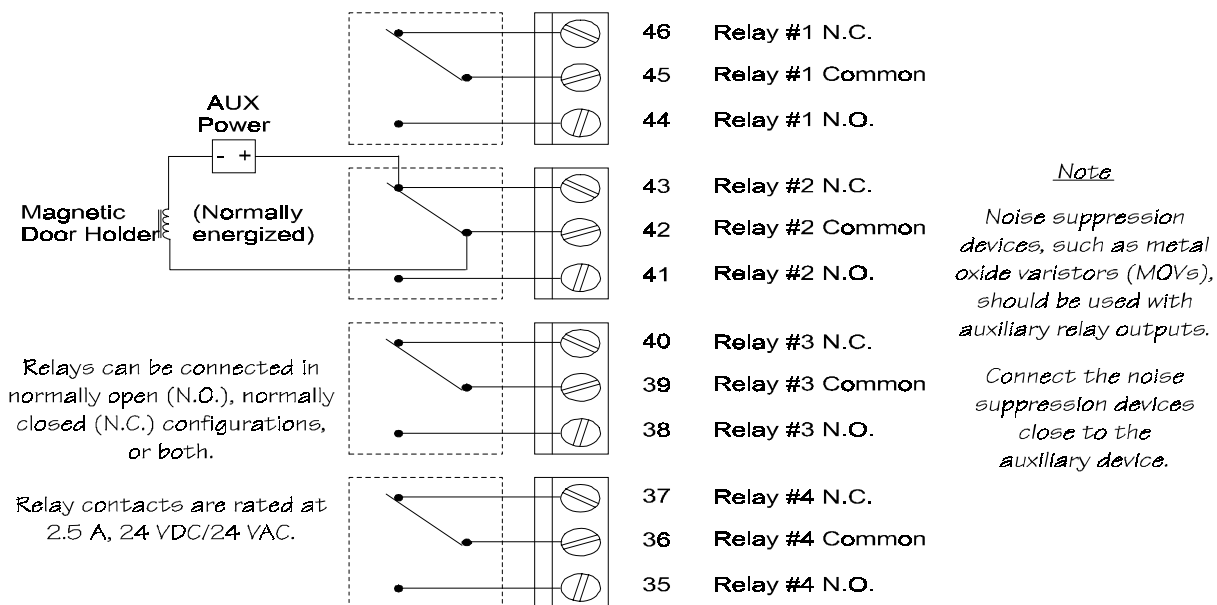

Figure 4-16 Auxiliary Relays



# Section 5

## Operation

To operate the 5207 you can use either the built-in touchpad or the Model 5230 Remote Annunciator.

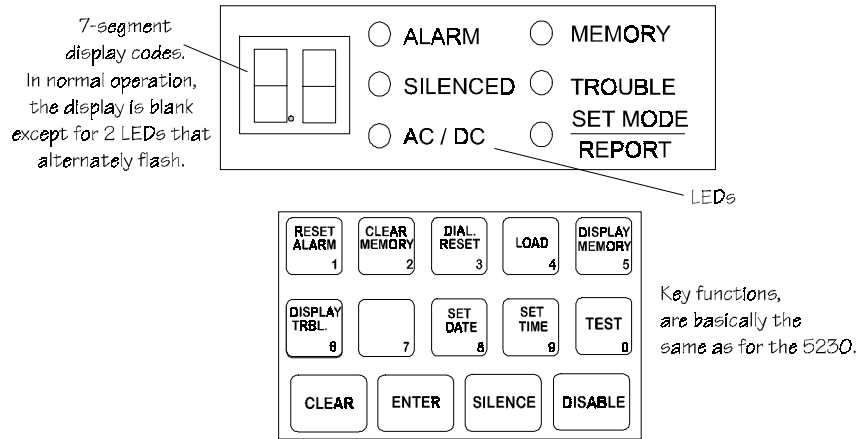

**Figure 5-1 Built-in Touchpad (Seven-Segment Display)**

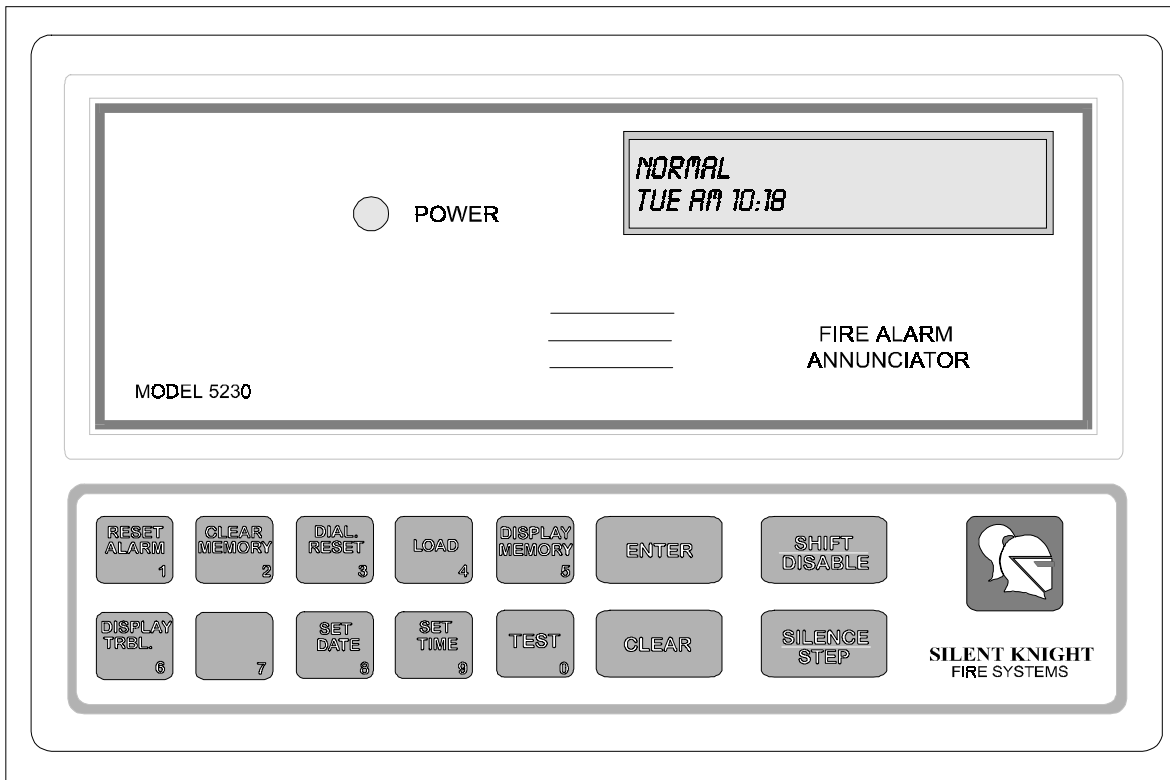

**Figure 5-2 Model 5230 Remote Annunciator**

## 5.1 Built-in Touchpad and Model 5230 Operation

Basic operation of both the 5230 and the built-in touchpad is described in Table 5-1. Note that if no keys are pressed for 15 minutes while in program mode, the system will time out and resume normal operation.

*Notes: A valid operating code is required for most functions when using the 5230. In Table 5-1, code = any valid operating code, code 0 = installer's code, and code 1 = main user's code.*

*If the NEED CODE AT PANEL option is selected in programming (Step 3), the following operations will require a valid code when using the built-in touchpad: Silence, Reset alarms, Clear alarm memory, Test.*

**Table 5-1 5207 Operation**

To			Additional Information
	5230 Annunciator	Built-in Touchpad	
Test the system	[0] [ENTER] + code	[0] [ENTER]	The system will perform a display lamp test, a bell test, and a communicator test. <i>(Note: Bells or relays programmed to activate on "Pre-Alarm" or "Trouble" do not activate during a test.)</i>
Reset alarms (or smoke detectors)	[1] [ENTER] + code	[1] [ENTER]	If there is no alarm, this procedure resets the smoke detectors.
When a trouble condition occurs and you reset the alarm, the trouble condition is stored in memory until you clear the alarm memory. If the alarm memory is not cleared, the trouble condition is displayed the next time a trouble condition occurs, implying incorrectly that more than one trouble condition exists.			
Clear alarm memory	[2] [ENTER] + code	[2] [ENTER]	Clears alarm memory and resets the 4180. (This function removes all memory of alarms.)
Reset the dialer	[3] [ENTER] + code 0 or 1	[3] [ENTER] + code 0 or 1	Resets the dialer (aborts a call).
Initiate download	[4] [ENTER] + code 0 or 1	[4] [ENTER] + code 0 or 1	Starts the downloading process. Exit downloading mode by pressing [CLEAR] [CLEAR].
Display alarm memory	[5] [ENTER]	[5] [ENTER]	Displays current alarm memory. (It is recommended that you clear alarm memory after displaying it.)
Display troubles	[6] [ENTER]	[6] [ENTER]	Displays trouble conditions.
Silence troubles or alarms	[SILENCE] + code OR [7] [ENTER] + code	[SILENCE] OR [7] [ENTER]	If silencing audible signals, you may need to enter a code.

**Table 5-1 5207 Operation**

To	5207 Operation		Additional Information
	5230 Annunciator	Built-in Touchpad	
Set date	[8] [ENTER] + code 0 or 1	[8] [ENTER]	See explanation below.
<p>The SET MODE LED will turn on and the built-in touchpad display will flash "-8" indicating that you are in SET DATE mode. Enter six digits for the date. For example, to set the date for 08/15/97, enter the following digits: [0] [8] [1] [5] [9] [7]. Once you press the last digit of the date, the SET TIME LED will turn off and the date will be changed. To exit Set Date mode, press [CLEAR] [CLEAR].</p>			
Set time	[9] [ENTER] + code 0 or 1	[9] [ENTER]	See explanation below.
<p>The SET MODE LED will turn on and the built-in touchpad display will flash "9" indicating that you are in Set Time mode. Enter six digits for the time. The first digit indicates day of the week ([0] = Sunday, [1] = Monday, etc.). The second digit indicates time of day ([0] = AM, [1] = PM). The last four digits are the actual time. For example, to set the time for Wednesday, 4:30 p.m., you would enter: [3] [1] [0] [4] [3] [0]. Once you press the last digit of the time, the SET TIME LED will turn off and the time will be changed. To exit Set Time mode in the middle of the sequence, press [CLEAR] [CLEAR].</p> <p>Note: If you are powering up the 5207, you will be in Set Time mode with "-9" showing on the display. In this case, you don't need to press [9]. Just enter the six digits for the time.</p>			
Disable/Enable zones	Zone # + [DISABLE] + code	Zone # + [DISABLE] + code	Disables or enables a zone. When a zone is disabled, there will be an alert tone that cannot be silenced until the zone is enabled.
Fire drill	Begin: [2] [0] [ENTER] + code 0 or 1  End: [SILENCE] + code	Begin: [2] [0] [ENTER] + code 0 or 1  End: [SILENCE]	Complete instructions appear in Section 5.2.1.
Walk test	Enter: [2] [2] [ENTER] + code 0 or 1  Exit: [SILENCE] [SILENCE] [CLEAR] [CLEAR]	Enter: [2] [2] [ENTER] + code 0 or 1  Exit: [SILENCE] [SILENCE] [CLEAR] [CLEAR]	Complete instructions appear in Section 5.2.2.
Zone trouble-shooting mode	Enter: [2] [5] [ENTER] + code 0 or 1  Exit: [CLEAR] [CLEAR]	Enter: [2] [5] [ENTER] + code 0 or 1  Exit: [CLEAR] [CLEAR]	Complete instructions appear in Section 9.3
Step programming mode	Enter: [2] [7] [ENTER] + code 0  Exit: [STEP] [STEP] [CLEAR] [CLEAR]	Not applicable.	Step programming is explained in detail in Section 7.

## 5.1.1 Built-in Touchpad Display Codes

The following table briefly describes the codes that are displayed on the built-in touchpad. For complete information and for 5230 display messages, see Section 9.

**Table 5-2 Built-in Touchpad Display Codes**

Display	Meaning
0	Fire drill (with Alarm, Alarm Memory, or Trouble LED).
1 - 16	Zone numbers (with Alarm, Alarm Memory, or Trouble LED).
A1 - A4	Trouble with specified bell output.
AC	Low AC condition.
dC	Low battery condition.
dF	Dialer failed after programmed number of attempts have been made.
dL	Data lost during attempt to transmit to the central station. This condition occurs after total attempts to communicate have been made.
E0	Trouble with the dialer.
E7	Trouble with EEPROM.
F0	5230 annunciator power trouble.
F1 - F7	Trouble with specified annunciator (1-7).
L1 - L2	Phone line fault on specified phone line.
P0	Printer is out of paper.
P1	Trouble with smoke detector power.
P2	Accessory power (terminal 26) trouble.
P3	Earth ground fault to circuit ground. See Section 9.2 for more information.
P4	Earth ground fault to power. See Section 9.2 for more information.
-0	Fire drill
-2	Walk test
-4	Downloading
-5	Zone troubleshooting mode
-6	Hex programming mode
-7	Step programming mode
-8	Set Time mode
-9	Set Date mode
2-, 3-, etc.	Prompts indicating that the user needs to enter a code.

## 5.1.2 LED Indicators

Six light emitting diodes (LEDs) appear in the 5207 cabinet window. The chart below explains the meaning of these LEDs.

LED	Status	Condition
ALARM (red)	Off	Normal condition
	On	Supervisory and Tamper condition
	Flashing	Alarm
SILENCED (yellow)	Off	Normal condition.
	On	Alarm or trouble condition has been silenced but condition still exists.
AC / DC (green)	On	Panel is running on AC (normal condition); standby battery fully charged.
	Off	Panel has lost all power.
	Flashing	Panel is running on battery power only or AC power only.
MEMORY (yellow)	Off	Normal condition
	On	An alarm condition has been reset. Alarm memory contains data.
TROUBLE (yellow)	Off	Normal condition
	On	Trouble condition exists
SET MODE REPORT (yellow)	Off	Normal condition
	On	System is in a Set (Test or Program) mode.
	Flashing	System is reporting.

## 5.2 System Testing

---

This section describes operation of fire drills, zone testing, and the 24-hour automatic test.

### 5.2.1 Fire Drills

Fire drills can be run from either the built-in touchpad or the Model 5230 Remote Annunciator. To initiate a fire drill, press **[2] [0] [ENTER]** + Code 0 or 1. The system will sound an alarm and report a fire test. To end the fire drill, press **[SILENCE]** + code.

## 5.2.2 Walk Test (Mode 22)

The walk test is designed to be used for onsite testing only.

To enter walk test mode, press **2** **2** **ENTER** + code 0 or 1. The LCD will indicate that you are in walk test mode. When a zone is tripped, the 5207 will activate the bell outputs for approximately one second and will cycle smoke power off and on for the programmed time interval. (Pre-alarm zones will not be delayed, but smoke verification zones will go through the verification delay.) When smoke power is restored, there is a two-second power up delay before the zone will respond to additional test inputs.

The system will time out and resume normal operation in 15 minutes if no keys are pressed or no zones are tripped during the walk test.

To exit walk test mode, press **SILENCE** **SILENCE** **CLEAR** **CLEAR**.

*Note: The ESL-429 series smoke detectors are NOT compatible when operating the 5207 panel in walk test mode. In walk test mode, the built-in self test on the ESL 429 series smoke detectors may be unreliable.*

*If the built-in self test is required, it should be done in the normal operating mode with the zone speed set to 3 seconds or higher.*

*Note that these smoke detectors are incompatible only for walk tests, not for any other normal 5207 system operation.*

## 5.2.3 Automatic Self Test

The Model 5207 lets you select the time of day that the 24-hour automatic test signal will be sent to the central station.

The Auto Test dialer test sent automatically at specified times. Immediately following the test, the 5207 also sends all unrestored events as required by UL. The events will have no indication when they occurred, so central station personnel should maintain records of unrestored events, or, if that is not possible, treat all alarms, troubles, and supervisories that come in during an auto test as if they were new events.

## 5.3 Watchdog Circuit

---

During normal operation, the control microprocessor of the 5207 is constantly running programs to check inputs and carry out other routine functions. If the program should ever stop running, the watchdog circuit will automatically detect this and attempt to resume normal operation by resetting the microprocessors. Each time the watchdog circuit initiates a reset signal, it will also sound the audible trouble signal for approximately four seconds.

# Section 6

## Programming: Quick Reference

This section of the manual briefly describes all available programming options and lists the factory programmed default values. Section 7 of this manual is a complete, step-by-step guide that provides details, including LCD diagrams, of each programming step. Please read Section 7 thoroughly, especially if you have never programmed the 5207 before.

The quick reference chart can be used for keeping track of how options have been programmed for an installation. The drawing below explains how to use the quick reference chart.

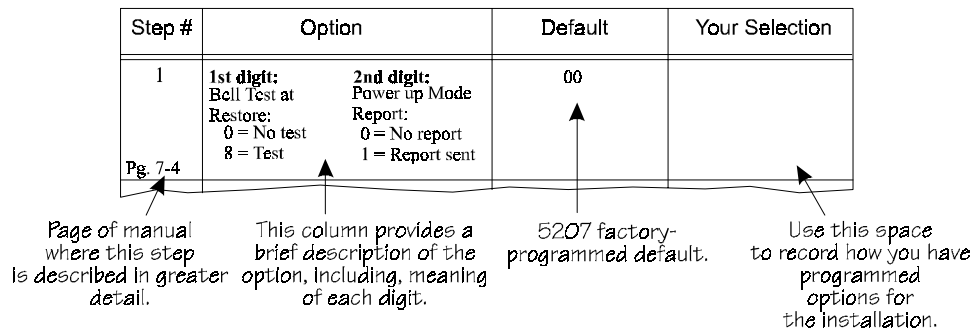

**Figure 6-1 How to Use the Programming Quick Reference Chart**

Step #	Option	Default	Your Selection
1 Pg. 7-4	<u>1st digit:</u> Bell Test at Restore: 0 = No test 8 = Test <u>2nd digit:</u> Power up Mode Report: 0 = No report 1 = Report sent	00	
2 Pg. 7-4	Enable Devices:  0 = Dialer 1 = Printer 2-6 Unused 7 = 24V system (Do not change factory programming.)	0 - - - - - 7	
3 Pg. 7-5	Options:  0 = Cadenced pulsing of bells 1 = Code required at panel 2 = Trouble alert tone for pre-alarm sound 3 = Pulsing fire bells 4 = Sound smoke delay 5 = Report fast restores 6 = Do not de-select. 7 = Time displays in military format	- - - - - 6 -	

Step #	Option	Default	Your Selection
4 Pg. 7-5	<p><u>1st digit:</u> (Display Rate) 0 = .5 sec 1 = 1 sec. 2 = 1.5 sec. 3 = 3 sec.</p> <p><u>2nd digit:</u> 0-7 = Max. number of supervised touchpads (0 means none.)</p>	20	
5 Pg. 7-6	<p>Misc. Options:</p> <p>0 = Report walk tests 1 = Do NOT de-select 2 = Detect ground fault</p> <p>3 = Sequential bell test 4 - 7 = Supervise bells 1-4</p>	-1234567	
6 6.1 6.2 6.3 6.4 6.5 6.6 6.7 6.8 6.9 6.10  Begins on Pg. 7-6	<p>Internal Zone Options (zones 1-8)</p> <p>24-hour alarm (do not change default) Select zones to be supervised for trouble Unused (do not change default) Zones will be Normally Open (do not change default) Zone response speed 2 or 4 Zone response speed 3 or 4 Unused Pre-alarm delay Smoke verification delay Number of zones that can be disabled</p>	<p>12345678 12345678 ----- 12345678 12345678 ----- ----- ----- ----- ----- 12345678</p>	<p>_____ _____ _____ _____ _____ _____ _____ _____ _____ _____</p>
7 7.1 7.2 7.3 7.4 7.5 7.6 7.7 7.8 7.9 7.10  Begins on Pg. 7-9	<p>External Zone Options (zones 9-16)</p> <p>24-hour alarm (do not change default) Select zones to be supervised for trouble Unused (do not change default) Zones will be Normally Open (do not change default) Zone response speed 2 or 4 Zone response speed 3 or 4 Unused Pre-alarm delay Smoke verification delay Number of zones that can be disabled</p>	<p>90123456 90123456 ----- 90123456 90123456 ----- ----- ----- ----- 90123456</p>	<p>_____ _____ _____ _____ _____ _____ _____ _____ _____ _____</p>
8 Pg. 7-10	Total number of zones in system	8	
9 Pg. 7-10	<p>Dialer Options:</p> <p>0 = Retry if fail 1 = Enable phone line 2 2 = Unused (do not select) 3 = Ground start (do not use in UL installations)</p> <p>4 = Enable phone line monitor 5 = Answer ring detect 6 = Unused (do not select) 7 = Up/downloading</p>	- 1 - - - 5 - 7	



Step #	Option	Default	Your Selection
10 Pg. 7-11	Total number of dialing attempts.	0	
11 Pg. 7-11	Number of dialing attempts before dialer fail.	0	
12 Pg. 7-11	Low AC hours (UL requires range of 6-12 hours.)	6	
13 Pg. 7-11	Number of rings to activate downloading.	10	
14 14.1 Begins on Pg. 7-12	Telephone # for reporting:  Report alarms to: 1 = Ph. #1 2 = Ph. #2 3 = Ph. #3 4 = Ph. #4  Report troubles to: 5 = Ph. #1 6 = Ph. #2 7 = Ph. #3 8 = Ph. #4	1 - - - 5 - - -	
14.2	Report disabled zones to: 1 = Ph. #1 2 = Ph. #2 3 = Ph. #3 4 = Ph. #4  Report restores to: 5 = Ph. #1 6 = Ph. #2 7 = Ph. #3 8 = Ph. #4	1 - - - 5 - - -	
14.3	Report open resets to: 1 = Ph. #1 2 = Ph. #2 3 = Ph. #3 4 = Ph. #4  5-8 = Not used.	1 - - - - - - -	
14.4	1-4 = Not used.  Report tests to: 5 = Ph. #1 6 = Ph. #2 7 = Ph. #3 8 = Ph. #4	- - - - 5 - - -	
14.5	Must Report: 1 = Ph. #1 2 = Ph. #2 3 = Ph. #3 4 = Ph. #4  Select Options: 5 = Line 1 is Touch-Tone 6 = Line 1 is Touch-Tone 7 = Use Touch-Tone only 8 = Enable 16-zone reporting	1 - - - - - - -	
15 Pg. 7-13	Computer phone number for up/downloading.	[blank]	



Step #	Option	Default	Your Selection
23	Select relays (digits 1-4) and bells (digits 5-8) to activate for:		
23.1	Pre-alarm conditions	-----	_____
23.2	Tamper alarms	-----	_____
23.3	Special (auxiliary) alarms	-----	_____
23.4	Fire alarms	---- 5678	_____
23.5	Trouble conditions	1 -----	_____
23.6	No silence conditions	-----	_____
Pg. 7-17			
24.0 - 24.16	Select alarm relay (digits 1-4) and bells (digits 5-8) to activate by zone.  24.0 selects bells and relays to activate during a fire drill. Steps 24.1-24.16 select bells and relays to activate for alarms in zones 1-16.	-----	
Pg. 7-19			
25.0 - 25.16	<u>1st digit:</u> Audible signal  0 = Bells can shut down 2 = Cross alarm delay 4 = No manual bell sound 8 = No auto bell shutdown A = Cross alarm and no shut down	<u>2nd digit:</u> Zone type  0 = Fire drill 1 = Fire 3 = Panic 5 = Tamper 6 = Sprinkler 7 = Undefined auxiliary 8 = Water 9 = Heat A = Cold B = Local C = Unused (do not select)	8 1  Use space on next page to record options.
Pg. 7-20			
26.1- 26.16	Zone location descriptions. See Table 6-1 for list.	WORDS	Use space on next page to record options.
Pg. 7-21			
27	Length of temporal (pulsing) pattern	32	Use space on next page to record options.
Pg. 7-22			
28	Cadence pattern (used with step 27)		Use space on next page to record options.
28.1	First group of 8 bits	12345678	
28.2	Second group of 8 bits	12345678	
28.3	Third group of 8 bits	12345678	
28.4	Fourth group of 8 bits	-----	
Pg. 7-22			

<b>Zone</b>	<b>Zone Type</b>	<b>Audio Type</b>	<b>Bells/Relays to Activate in Alarm</b>	<b>Location Descriptions</b>
1				
2				
3				
4				
5				
6				
7				
8				
9				
10				
11				
12				
13				
14				
15				
16				

# Section 7

## Programming: Step-by-Step Complete Reference

The Model 5230 Remote Annunciator is for programming the 5207 panel. You must be in Step Programming Mode (also known as mode 27) to program the panel. See the following sections for details.

### 7.1 Using Step Programming

Enter Step Programming mode	<p>Press <b>[2][7][ENTER]</b>, followed by the code that has been programmed as code 0 (the factory programmed value for code 0 is 123456). If you have entered mode 27 correctly, the display will show 1 PWR UP CLR (Step 1, Power-up Clear). Press <b>[ENTER]</b> to make selections for this step. Press <b>[ENTER]</b> again to move to the next step.</p> <p><i>Note: If you receive a trouble beep and the message TRY AGAIN appears, either you are not using the correct code 0, or the EEPROM could be malfunctioning. If the problem is the EEPROM, you must obtain a new default EEPROM from Silent Knight.</i></p>
Exit Step Programming	<p>Press <b>[STEP][STEP][CLEAR][CLEAR]</b>. You will return to normal operation.</p>
Moving through the Steps and Sub-Steps	<p><b>To move sequentially through the options:</b>          Press <b>[ENTER]</b> until you reach the step (option) you want to program.</p> <p><b>To go directly to step:</b>          If you know the step you want to go to, you can save time by moving directly to the step. Press <b>[STEP][STEP]</b>. Enter the desired step number, then press <b>[ENTER]</b>. The new step will be displayed.</p> <p><b>To go to directly a sub-step:</b>          Some steps contain sub-steps (see the diagram on the next page for an example). To go to a particular sub-step, first go to the step. Then, press <b>[STEP]</b> followed by the substep number and press <b>[ENTER]</b>. For example, to go to step 14.2, you would press the following sequence of keys: <b>[STEP][STEP][1][4][ENTER][STEP][2]</b></p> <p style="text-align: right;"><i>chart continued on next page</i></p>

<p>Selecting Options</p>	<p><b>Scrolling</b></p> <p>For most options, you enter numbers in the same way as if you were using a calculator. The digits appear on the right side of the display and scroll to the left as you continue to enter data.</p> <div style="text-align: center;"> <p style="font-size: small;">Step #</p> <p style="font-size: small;">Sub-step #</p> <p style="font-size: small;">Description of option</p> <p style="font-size: small;">Current selections for this option. A digit indicates the option has been selected; blank indicates an option is not selected.</p> </div>
	<p><b>Toggling</b></p> <p>In some steps, pressing a key will cause the corresponding digit to appear and disappear on the display. When a digit appears, it indicates that the option is selected. A dash indicates that the option is not selected. In the following example, options 1, 5, and 7 are selected:</p> <div style="text-align: center;"> </div>
	<p><b>Entering numbers greater than 9</b></p> <p>Use the <b>SHIFT</b> key as shown below to enter numbers 10-15. Hexadecimal digits (in parentheses) appear on the screen to represent these numbers.</p> <p><b>SHIFT</b> 1 = 10 (A)  <b>SHIFT</b> 2 = 11 (B)  <b>SHIFT</b> 3 = 12 (C)  <b>SHIFT</b> 4 = 13 (D)  <b>SHIFT</b> 5 = 14 (E)  <b>SHIFT</b> 6 = 15 (F)</p>

## Programming Examples

The following examples demonstrate how to use Step Programming. The selections you make in each installation will vary depending on each customer's needs. The way you move through Mode 27 may also vary from how it is described here.

<p><b>Example 1: Programming Location Description Names</b></p> <p>Suppose you want to program the Model 5230 Annunciator to display meaningful location names for Zones 3 and 5. The words you wish to display are GARAGE for Zone 3 and EAST OFFICE for Zone 5. These words are part of the 5230 library of names and can be selected using Step Programming. See Table 2-2 for a complete list of words contained in the library.</p>	<p><i>One-Word Display</i></p> <ol style="list-style-type: none"> <li>1. From the 1 PWR UP CLR display, press <b>[2][6][ENTER]</b> to go to Step 26.1.</li> <li>2. Press <b>[ENTER]</b> until you reach Zone 3. The first line of the LCD will read <b>[26.3]</b>.</li> <li>3. Press <b>[1]</b> as many times as necessary until the word GARAGE is displayed on the LCD. Press <b>[ENTER]</b> to select.</li> </ol> <p><i>Two-Word Display</i></p> <p>To program Zone 5 to display EAST OFFICE, you will have an additional step since you are programming two words instead of one.</p> <ol style="list-style-type: none"> <li>1. If necessary, enter Step Programming mode from the Date/Time display by pressing <b>[2][7][ENTER]</b>, then enter your access code.</li> <li>2. From the 1 PWR UP CLR display, press <b>[2][6][ENTER]</b> to go to Step 26.1. (If you are already in Step 26, just press <b>[STEP]</b>, then the number of the zone you want to change and press <b>[ENTER]</b>.)</li> <li>3. Press <b>[ENTER]</b> until you reach Zone 5. The first line of the LCD will read <b>[26.5]</b>.</li> <li>4. Press <b>[1]</b> as many times as necessary until the word EAST is displayed on the LCD.</li> <li>5. To add the second word, press <b>[2]</b> until you reach OFFICE. Press <b>[2][7][ENTER]</b> to select.</li> </ol>
<p><b>Example 2: Adding a New Access Code</b></p>	<ol style="list-style-type: none"> <li>1. If necessary, enter Step Programming mode from the Date/Time display by pressing <b>[2][7][ENTER]</b>, then enter your access code.</li> <li>2. From the 1 PWR UP CLR display, press <b>[2][2][ENTER]</b>.</li> <li>3. Press <b>[STEP]</b>.</li> <li>4. Press the number of the code you want to add or change. Press <b>[ENTER]</b>.</li> <li>5. Enter the new access code number. Press <b>[ENTER]</b>.</li> </ol>

## 7.2 Step Programming Options

This section is organized in step order and provides complete instructions for each step.

### Step 1. Power Up Clear

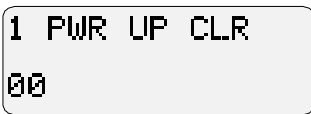
Display	Description
 <p>1 PWR UP CLR 00</p>	<p>The two digits of this step are used to program two options, BELL TEST AT RESTORE (digit 1) and DEFAULT MODE (power up) REPORTING (digit 2).</p> <p><b>Digit 1:</b></p> <p>0 = No bell test at restore. 8 = Bell test will occur at restore.</p> <p><b>Digit 2:</b></p> <p>0 = A report will not be sent if the system enters power up mode. 1 = An "open" report will be sent if the system enters power up mode.</p> <p><b>Example 1:</b> If you select "80" for this step, a bell test will occur at restore (digit 1) and no report will occur if the system enters power up mode (digit 2).</p> <p><b>Example 2:</b> If you select "01" for this step, a bell test will not occur at restore (digit 1) and the system will report "Open" if it enters power up mode (digit 2).</p>

### Step 2. Device Enables

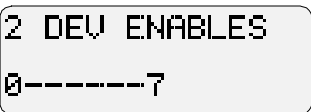
Display	Description
 <p>2 DEV ENABLES 0-----7</p>	<p>Step 2 allows you to enable the dialer, printer, and 24-volt smoke power.</p> <p><b>0 = Dialer.</b> The dialer must be enabled. Do not change the factory programming.</p> <p><b>1 = Printer.</b> Enable the printer if your installation includes a 5260 printer interface. (The 5260 is not UL listed for use with the 5207.)</p> <p><b>7 = 24-V System.</b> Enables 24V power. Do NOT disable.</p> <p><b>2 - 6 = Unused.</b> These digits are reserved by the manufacturer for future use. Leave these blank at all times.</p>



### Step 3. More System Options

Display	Description
	<p>Step 3 allows you to select seven system options shown below. To select an option, press its number.</p> <p><b>0 = Cadenced pulsing of bells.</b> If you select this option, bells will pulse in the pattern shown below (for customizing patterns, refer to Steps 27 and 28):            3.5 seconds on, .5 seconds off            3.5 seconds on, .5 seconds off            3.5 seconds on, 4.5 seconds off</p> <p><b>1 = Code required at the panel.</b> If you select this option, users will have to enter a code to perform tasks on the built-in touchpad.</p> <p><b>2 = Trouble alert tone used for pre-alarm sound.</b> If you choose this option the built-in trouble alert will sound when a trouble condition occurs.</p> <p><b>3 = Pulsing fire bells.</b> Select this option if you want fire alarm bells to pulse one second on, one second off. (If you want fire bells to have cadenced pulsing instead of one second on, one second off pulsing, choose both this option AND cadenced pulsing.)</p> <p><b>4 = Trouble alert tone will sound during smoke delays.</b> If you choose this option, the built-in trouble alert sounder will sound when a trouble condition occurs.</p> <p><b>5 = Report fast restores.</b> This option causes restores that occur as soon as the alarm situation is corrected instead of waiting for the shutdown time.</p> <p><b>6 = Must be enabled.</b> Do NOT de-select.</p> <p><b>7 = Time displays in military format.</b> If you select this option, the system time will display in the 24-hour military format instead of the 12-hour with AM/PM format.</p>



### Step 4. Display Rate

Display	Description
	<p>The two digits of this step are used to program two options that have to do with the Model 5230 Remote Annunciator.</p> <p><b>Digit 1 = The rate that the 5230 LCD displays text, that is, how long a display stays on the LCD.</b> The choices are:            0 = 0.5 sec            1 = 1 sec            2 = 1.5 sec            3 = 3 sec</p> <p><b>Digit 2 = Maximum number of supervised annunciators.</b> Enter 0-7. "0" means no annunciators will be supervised.</p> <p><b>Example:</b>            Entering "14" for this step indicates that all annunciators will display text for 1 second (Digit 1) and your installation has 4 (1-4) annunciators (Digit 2).</p>

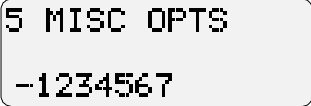
## Step 5. Miscellaneous Options

Display	Description
	<p>Step 5 is for programming several system options, including bell supervision.</p> <p><b>0 = Walk tests will be reported.</b> Select this option if you want walk tests reported to the central station.</p> <p><b>1 = A feature that makes the system clock more accurate.</b> Do NOT de-select.</p> <p><b>2 = Ground fault detection enabled.</b> This is required. Do NOT de-select.</p> <p><b>3 = Sequential bell test.</b> Enabling this option means that when a dialer test or power-up occurs, the four bells will ring sequentially (first bell 1, then bell 2 and so on), instead of all four at the same time.</p> <p><b>4 = Bell 1 is supervised.</b> This option must be enabled if bell 1 is used.</p> <p><b>5 = Bell 2 is supervised.</b> This option must be enabled if bell 2 is used.</p> <p><b>6 = Bell 3 is supervised.</b> This option must be enabled if bell 3 is used.</p> <p><b>7 = Bell 4 is supervised.</b> This option must be enabled if bell 4 is used.</p>

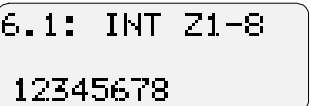
## Step 6. Internal Zone Options

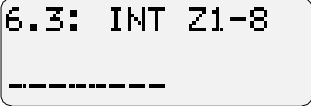
Display	Description
	<p>Step 6 is for programming various options for zones 1-8. To select an option for a zone, go to the appropriate substep and enter the zone number. (Options for expansion zones 9-16 are programmed in Step 7.)</p> <p><b>Example:</b></p> <p>Suppose you want zones 2 and 3 to be pre-alarm delayed. Pre-alarm delays are programmed at Step 6.8. Press "23" at Step 6.8.</p>
	<p><b>24 Hour alarm</b>—Zones will be active 24 hours. Must be selected for all zones. Do NOT change the factory programming for this step.</p>
	<p><b>Trouble Supervised</b>—Select zones that will be supervised for trouble (typically this is all zones).</p>
	<p>Option not used. Do NOT select anything.</p>

Display	Description
<div style="border: 1px solid black; padding: 5px; width: fit-content;">                     6.4: INT Z1-8                      12345678                 </div>	<p><b>Normally Open zones</b>—Zones will be Normally Open. Must be selected for all zones. Do NOT change the factory programming for this step (NFPA requires that all fire zones be programmed as N.O. supervised).</p>
<p><i>Steps 6.5 and 6.6 are for programming zone response time. For more information see “Programming Zone Response Time”, especially if you have never programmed loop response times with the 5207.</i></p>	
<div style="border: 1px solid black; padding: 5px; width: fit-content;">                     6.5: INT Z1-8                      12345678                 </div>	<p>Use this step to select the 3-to-4 second or 30-to-40 second response times for zones 1-8. Select the zone numbers of the zones that should have either of these speeds. For the 30-to-40 second speed, you will have to enter the zone numbers again in Step 6.6. Note that the default for all zones is 3 to 4 seconds. You will need to de-select any zones that should not have the 3-to-4 or 30-to-40 response times by pressing the zone number so that it is not displayed on the LCD. See Table 6-1.</p>
<div style="border: 1px solid black; padding: 5px; width: fit-content;">                     6.6: INT Z1-8                      -----                 </div>	<p>Use this step to select the 15-to-20 second or 30-to-40 second response times for zones 1 to 8. Select the numbers of the zones that should have either of these speeds. For the 30-40 second speed, you should also have entered the zone numbers in Step 6.5. Be sure to de-select any zones that should not be displayed in this step. See Table 6-1.</p>

**Programming Zone Response Time (Steps 6.5 & 6.6)**

There are four possible response times. To program the response times, select the zone number that should have that response time in Steps 6.5 and 6.6, as follows:

**Table 6-1 Steps 6.5 and 6.6 Programming**

Desired Speed for Zone	Step 6.5	Step 6.6	Explanation
0.094 - 0.25 seconds	Do not select zone number.	Do not select zone number.	Leave the zone number blank in both steps for any zones that should have this response time.
<p><i>Note: This very fast response time can increase the possibility of false alarms, since transients and other interference can set off alarm conditions in such a short time span. <b>Silent Knight recommends that you do not use this response time unless you have to</b> (because, for example, the installation you are protecting requires this quick a response time even if false alarms could result).</i></p>			
3 to 5 seconds	Select zone number.	Do not select zone number.	<i>In Step 6.5 only</i> , select the zone number of zones 1-8 that should have this response time.
15 to 20 seconds	Do not select zone number.	Select zone number.	<i>In Step 6.6 only</i> , select the zone number of zones 1-8 that should have this response time.
30 to 40 seconds	Select zone number.	Select zone number.	<i>In both Steps 6.5 and 6.6</i> , select the zone number of zones 1-8 that should have this response time.

**Example:**

To program an 8-zone installation where you want loop response speeds to be as follows:

Zone 1: 0.094 - 0.125 sec.

Zones 2-5: 3-4 sec.

Zones 6-7: 15-20 sec.

Zone 8: 30-40 sec.

**Do This:**

In Step 6.5, select zones 2, 3, 4, 5, and 8. Make sure that zone 1 is not selected. Your LCD would appear as shown below:

```
6.5: INT Z1-8
-2345--8
```

In Step 6.6, select zones 6, 7, and 8. Make sure that zone 1 is not selected. Your LCD would appear as shown below:

```
6.6: INT Z1-8
-----678
```

Display	Description
<pre>6.7: INT Z1-8 -----</pre>	<p>Not used. Do not select any zones for this option.</p>
<pre>6.8: INT Z1-8 -----</pre>	<p><b>Pre-alarm delay.</b> Use this step to select a pre-alarm delay for zones 1 to 8. When this delay is selected for a zone, it means that the panel will not immediately go into alarm. Alarm responses and reporting will be delayed for the programmed duration (duration programmed in Step 20.3). Any outputs programmed for pre-alarm (in Step 23.1) will activate. At the end of the pre-alarm time, if the alarm has not been reset, the panel will go into alarm.</p>
<pre>6.9: INT Z1-8 -----</pre>	<p><b>Smoke verification delay.</b> For use with smoke detectors only (not for manual pull stations). Use this step to select any zones that will be controlled by a smoke detector delay. This means that the smoke detector will delay for a specified amount of time before responding to an alarm condition. (The duration of the delay is programmed in Step 20.4.)</p>
<pre>6.10: INT Z1-8 12345678</pre>	<p><b>Can be disabled.</b> For zones 1-8, enter the number of zones that can be disabled.</p>

## Step 7. External Zone Options

Display	Description
<div style="border: 1px solid black; padding: 5px; width: fit-content;">                     7.1: EXT Z9-16                      90123456                 </div>	<p><b>24 Hour alarm</b>—Zones will be active 24 hours. Must be selected for all zones. Do NOT change the factory programming for this step.</p>
<div style="border: 1px solid black; padding: 5px; width: fit-content;">                     7.2: EXT Z9-16                      90123456                 </div>	<p><b>Trouble supervised</b>—For zones 9 to 16, enter the number of zones that will be trouble supervised.</p>
<div style="border: 1px solid black; padding: 5px; width: fit-content;">                     7.3: EXT Z9-16                      -----                 </div>	<p>Not used. Do NOT select any zones for this option.</p>
<div style="border: 1px solid black; padding: 5px; width: fit-content;">                     7.4: EXT Z9-16                      90123456                 </div>	<p>This step sets all expansion zones as Normally Open. Do not change the factory programming for this step.</p>
<div style="border: 1px solid black; padding: 5px; width: fit-content;">                     7.5: EXT Z9-16                      90123456                 </div>	<p>Use this step to select the 3-to-4 second or 30-to-40 second loop response time for zones 9 to 16. If you need more information about how to program loop response time, see the explanation at Steps 6.5 and 6.6.</p>
<div style="border: 1px solid black; padding: 5px; width: fit-content;">                     7.6: EXT Z9-16                      -----                 </div>	<p>Use this step to select the 15-to-20 second or 30-to-40 second loop response time for zones 9 to 16. If you need more information about how to program loop response time, see the explanation at Steps 6.5 and 6.6.</p>
<div style="border: 1px solid black; padding: 5px; width: fit-content;">                     7.7: EXT Z9-16                      -----                 </div>	<p>Not used. Do not select any zones for this option.</p>
<div style="border: 1px solid black; padding: 5px; width: fit-content;">                     7.8: EXT Z9-16                      -----                 </div>	<p><b>Pre-alarm delay.</b> Use this step to select a pre-alarm delay for zones 1 to 8. When this delay is selected for a zone, it means that the panel will not immediately go into alarm. Alarm responses and reporting will be delayed for the programmed duration (duration programmed in Step 20.3). Any outputs programmed for pre-alarm (in Step 23.1) will activate. At the end of the pre-alarm time, if the alarm has not been reset, the panel will go into alarm.</p>

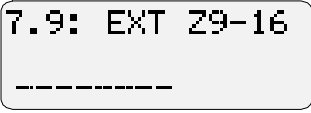
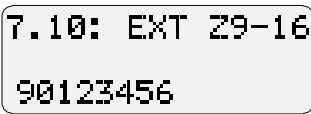
Display	Description
	<p><b>Smoke verification delay.</b> Use for smoke detectors only (not for manual pull switches) to select zones that will be controlled by a smoke detector delay. This means that the smoke detector will delay for a specified amount of time before responding to an alarm condition. (The duration of the delay is programmed in Step 20.4.)</p>
	<p><b>Can be disabled.</b> For zones 9-16, enter the number of zones that can be shunted.</p>

### Step 8. Number of Zones

Display	Description
	<p><b>Enter the total number of zones.</b> Do not enter more zones than the installation has. Doing so will trigger an alarm.</p> <p><i>Note: The last internal zone must be 8 unless the 5210 is used. Entering a larger number will trigger an alarm condition and you could experience difficulty returning to programming mode. If this occurs, press the following keys rapidly, repeating the sequence several times if necessary:</i></p> <p><b>ALARM RESET</b> <b>ENTER</b> (code) <b>2</b> <b>7</b> <b>ENTER</b> (code) <b>ENTER</b></p>

### Step 9. Dialer Options

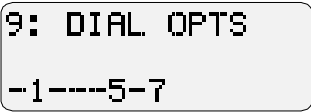
Display	Description
	<p><b>0 = Retry if fail.</b> If you want the 5207 to try again to send a report 15 minutes after all previous attempts have failed, select 0.</p> <p><b>1 = Enable phone line 2.</b> Choose if using a second phone line with the system.</p> <p><b>2 = Not used.</b> Do NOT select.</p> <p><b>3 = Ground start.</b> Must be selected for installations using a ground start telephone network. Ground start cannot be supervised by the line monitors as there is no DC voltage normally present. This option should not be used in UL installations.</p> <p><b>4 = Enable phone line monitor.</b></p> <p><b>5 = Answer ring detect.</b> Select if you want to the panel to answer after the specified number of rings for an up/download from a computer. The number of rings is programmed in step 13.</p> <p><b>6 = Not used.</b> Do NOT select.</p> <p><b>7 = Enable up/downloading.</b> Select this option if you will be using up/downloading with the system.</p>

### Step 10. Total Number of Attempts

Display	Description
<div style="border: 1px solid black; padding: 5px; width: fit-content;">                     10: TOT                      0                 </div>	<p><b>Total number of attempts to dial.</b> Select a number from 5 to 15. For a local-only system, select "0" for this step and for Step 11.</p>

### Step 11. Number of Events Before Dialer Failed

Display	Description
<div style="border: 1px solid black; padding: 5px; width: fit-content;">                     11: FAILS                      0                 </div>	<p><b>Number of dialing attempts before the system locally annunciates a dialer failed condition.</b> For a local-only system (no report to central station), select "0" for this step and for Step 10.</p>





### Step 12. Low AC Hours

Display	Description
<div style="border: 1px solid black; padding: 5px; width: fit-content;">                     12: LOW AC                      6                 </div>	<p>Number of hours (6-12) that AC is low before system reports AC TROUBLE. UL requires a range of 6-12 hours.</p>

### Step 13. Number of Rings

Display	Description
<div style="border: 1px solid black; padding: 5px; width: fit-content;">                     13: RINGS                      10                 </div>	<p><b>Number of rings before panel answers for up/downloading.</b> Enter a number from 1 to 15, or enter 0 if not used. If you are using this option, you must also select options "5" and "7" in step 9.</p>

## Step 14. Report to Telephone Numbers

Display	Description
 <p>14.1: REPORT TO 1---5---</p>	<p><b>The phone number to which alarms should be reported.</b> Select 1-4 for phone numbers 1-4. 1 = Report alarms to phone number 1 2 = Report alarms to phone number 2 3 = Report alarms to phone number 3 4 = Report alarms to phone number 4</p> <p><b>The phone number to which troubles should be reported.</b> Select 5-8 for phone numbers 1-4. 5 = Report troubles to phone number 1 6 = Report troubles to phone number 2 7 = Report troubles to phone number 3 8 = Report troubles to phone number 4</p> <p><b>Example:</b> Selecting "15" for this step indicates that both alarms and troubles will be reported to telephone number 1.</p>
 <p>14.2: REPORT TO 1---5---</p>	<p><b>The phone number to which disabled zones should be reported.</b> Select 1-4 for phone numbers 1-4.</p> <p><b>The phone number to which restores should be reported.</b> Select 5-8 for phone numbers 1-4. (This step is programmed the same as 14.1. See the explanation for Step 14.1 if you need more information.)</p>
 <p>14.3: REPORT TO 1-----</p>	<p><b>The phone number to which open resets should be reported.</b> Select 1-4 for phone numbers 1-4.</p> <p><b>Not used.</b> Do NOT select digits 5-8.</p>
 <p>14.4: REPORT TO -----5---</p>	<p><b>Not used.</b> Do NOT select digits 1-4.</p> <p><b>The phone number to which tests should be reported.</b> Select 5-8 for phone numbers 1-4.</p>
 <p>14.5: REPORT TO 1-----</p>	<p><b>The number to which reports MUST be sent.</b> Select 1-4 for phone numbers 1-4. This means that if the dialer is not able to report to this number, a failed message will automatically be generated.</p> <p><b>Select 5-8 according to the following:</b> 5 = Line 1 is Touch-Tone. 6 = Line 2 is Touch-Tone. 7 = Use Touch-Tone only. 8 = Enable 16-zone reporting.</p>



## Step 15. Computer Phone Number

Display	Description															
<div style="border: 1px solid black; padding: 5px; margin-bottom: 10px;">15: COMP PHONE</div> <p><b>Example:</b></p> <pre> outside line   ↓ 9A1D8885551212   ↑   ↑ pause 2nd       dial tone           </pre> <p style="margin-left: 40px;">"1" preceding long distance #</p>	<p>Enter the phone number the system will dial to up- or download system data.</p> <p><b>Entering Phone Numbers</b></p> <p>Phone numbers are 16 digits maximum. Besides numbers, you can enter characters representing a pause, * (star or asterisk key), # (number sign or pound key), and a second dial tone (see example).</p> <table style="width: 100%; border-collapse: collapse;"> <thead> <tr> <th style="text-align: left;"><u>To Enter:</u></th> <th style="text-align: left;"><u>Press:</u></th> <th style="text-align: left;"><u>LCD Displays:</u></th> </tr> </thead> <tbody> <tr> <td>Pause</td> <td><b>SHIFT</b> 1</td> <td>A</td> </tr> <tr> <td>*</td> <td><b>SHIFT</b> 2</td> <td>B</td> </tr> <tr> <td>#</td> <td><b>SHIFT</b> 3</td> <td>C</td> </tr> <tr> <td>2nd dial tone</td> <td><b>SHIFT</b> 4</td> <td>D</td> </tr> </tbody> </table>	<u>To Enter:</u>	<u>Press:</u>	<u>LCD Displays:</u>	Pause	<b>SHIFT</b> 1	A	*	<b>SHIFT</b> 2	B	#	<b>SHIFT</b> 3	C	2nd dial tone	<b>SHIFT</b> 4	D
<u>To Enter:</u>	<u>Press:</u>	<u>LCD Displays:</u>														
Pause	<b>SHIFT</b> 1	A														
*	<b>SHIFT</b> 2	B														
#	<b>SHIFT</b> 3	C														
2nd dial tone	<b>SHIFT</b> 4	D														

## Step 16. Central Station Phone Numbers

Display	Description
<div style="border: 1px solid black; padding: 5px; margin-bottom: 10px;">16.1: PHONE#</div> <div style="border: 1px solid black; padding: 5px;">5551234567890</div>	<p>The 5207 can report to four different central station telephone numbers. Two are required. Enter the numbers in Steps 16.1 - 16.4.</p> <p>See Step 15 if you need to know how to select digits and special characters for phone numbers.</p> <p>Steps 16.2 through 16.4 are programmed in the same way. Step 16.2 is for phone #2, 16.3 is for phone #3, 16.4 is for phone #4. (Default is blank for Steps 16.2-16.4.)</p>

## Step 17. Central Station Account Numbers

Display	Description
<div style="border: 1px solid black; padding: 5px; margin-bottom: 10px;">17.1: ACCOUNT#</div> <div style="border: 1px solid black; padding: 5px;">005207</div>	<p>Enter central station account #1. If the account number is less than six digits, you must enter leading zeros.</p> <p>Steps 17.2 through 17.4 are programmed in the same way. Step 17.2 is for account #2, 17.3 is for account #3, 17.4 is for account #4. (Default is blank for Steps 17.2-17.4.)</p>

## Step 18. Dialer Format and Number of Attempts

Display	Description
	<p><b>Digit 1 = Enter the number of attempts for account number 1.</b> This number is how many times the dialer will attempt to report to this account number before switching to the next number. (If only one account number is used, this number must be the same as Step 10.)</p> <p><b>Digit 2 = Enter the reporting format to be used for account number 1.</b> (Formats described in Section 8.)</p> <p>Options:</p> <ul style="list-style-type: none"> <li><b>0 = SIA8</b></li> <li><b>1 = FSK1</b></li> <li><b>2 = Not used</b> (do NOT select)</li> <li><b>3 = BFSK14</b></li> <li><b>4 = BFSK23</b></li> <li><b>5 = SIA20</b></li> <li><b>6 = SK 4+2</b></li> </ul> <p>Steps 18.2 - 18.4 are programmed in the same way. Step 18.2 is for account #2, 18.3 is for account #3, 18.4 is for account #4.</p>

## Step 19. Telephone Line to Use for Accounts

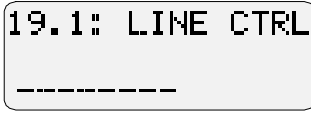
Display	Description
	<p>Program options for account number 1.</p> <ul style="list-style-type: none"> <li><b>1 = Use line 1 only.</b></li> <li><b>2 = Use line 2 only.</b></li> <li><b>3 = 9000 Direct line (no dial tone); do not use.</b></li> </ul> <p>0 and 4-9 are not used. Do NOT Select.</p> <p>If two lines are programmed, the panel automatically switches from line 1 to line 2. Use this step only if you have two different types of phone lines; for example, line 1 is loop start and line 2 is a PBX that requires a "9" or other number before to dial out.</p> <p>Steps 19.2 - 19.4 are programmed in the same way. Step 19.2 is for account #2, 19.3 is for account #3, 19.4 is for account #4.</p>



## Step 20. Duration of Delays

Display	Description
<div style="border: 1px solid black; border-radius: 10px; padding: 5px; width: fit-content;"> <p>20.1: DELAY</p> <p>90</p> </div>	<p><b>Bell Shutdown Time (1-255)</b> Divide by 10 and enter the number indicating the time that you want audio alarms to be active.</p> <p><b>Example:</b> Suppose you want audio alarms to be active for 900 seconds (or 15 minutes). Enter 900 divided by 10 or “90”.</p> <p>Common shutdown times:</p> <p style="padding-left: 20px;">5 minutes = 300 seconds. <b>Enter “30.”</b>            10 minutes = 600 seconds. <b>Enter “60.”</b>            15 minutes = 900 seconds. <b>Enter “90.”</b>            20 minutes = 1200 seconds. <b>Enter “120.”</b>            25 minutes = 1500 seconds. <b>Enter “150.”</b>            30 minutes = 1800 seconds. <b>Enter “180.”</b></p>
<div style="border: 1px solid black; border-radius: 10px; padding: 5px; width: fit-content;"> <p>20.2: DELAY</p> <p>30</p> </div>	<p>Step 20.2 is not used. Do NOT change the factory-programmed setting of “30”.</p>
<div style="border: 1px solid black; border-radius: 10px; padding: 5px; width: fit-content;"> <p>20.3: DELAY</p> <p>30</p> </div>	<p>Use this step to program the duration (1-255 sec.) of the pre-alarm delay.</p>
<div style="border: 1px solid black; border-radius: 10px; padding: 5px; width: fit-content;"> <p>20.4: DELAY</p> <p>30</p> </div>	<p>Use this step to set the duration (1-255 sec.) of the smoke verification delay.</p>
<div style="border: 1px solid black; border-radius: 10px; padding: 5px; width: fit-content;"> <p>20.5: DELAY</p> <p>2</p> </div>	<p>Use this step to program the number of seconds (2-7 sec.) it will take smoke detectors to reset. Refer to the manufacturer’s specification sheet for the times approved for your smoke detectors.</p>
<div style="border: 1px solid black; border-radius: 10px; padding: 5px; width: fit-content;"> <p>20.6: DELAY</p> <p>24</p> </div>	<p>Step 20.6 is not used. Do NOT change the factory-programmed selection of “24.”</p>

## Step 21. Test Time

Display	Description
	<p>Enter time that automatic daily test should occur using 24-hour military time. Enter 6 digits with leading zeros.</p> <p><b>Examples:</b>                      To program the daily test to occur at:                      2:30 AM, enter 000230.                      11:45 PM, enter 002345.                      Midnight, enter 000000.</p>

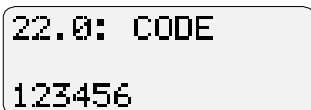
## Step 22. Secret Codes

Display	Description
	<p>Step 22 is for programming the 4- to 6-digit codes that give access to the system.</p> <p><b>Code 0</b>, programmed in Step 22.0, is the installer's code. This is the only code that can activate all system features. This code must be unique from all others. See IMPORTANT below.</p> <p><b>Code 1</b>, programmed in Step 22.1, is the main user's code. This code can access all system features except programming.</p> <p><b>Codes 2-9</b> are user codes. These codes enable users to bypass zones and reset alarms, but they cannot perform a walk test or change programming options.</p> <p>The 5207 can have up to 100 user codes, but the 5230 annunciator can program only 10 codes (codes 0-9). If you need more than 10 codes, use the 5541 downloading software.</p> <p><b>To change a code</b>, type in the new number when you are at the step for the code you want to change, then press <b>ENTER</b>.</p> <p><b>IMPORTANT:</b>                      When programming codes, make sure that the first four digits of Code 0 are different from the first four digits of all other codes. If other codes have the same digits, all users could be locked out of programming mode.</p>
	<p><b>Example:</b>                      Suppose you want to change Code 1 from "1111" to "5982."                      At Step 22.1, press <b>5 9 8 2 ENTER</b>.</p>

## Step 23. Group Relays and Bells

### IMPORTANT:

You can program relays and bells in **either** the Group section (Step 23) or the By Zone section (Step 24), but **not** both.

Relays and bells are programmed for the type of condition that causes them to activate, not by zone. An exception is relays and bells that activate for alarms, which can be programmed by zone. Use Step 24 to program alarm relays and bells by zone.

Display	Description
<div data-bbox="272 590 583 697" style="border: 1px solid black; padding: 5px; margin-bottom: 10px;"> <p>23.1: GRP RLY -----</p> </div> <p>This step selects bells and relays by type of condition. Step 24 is for selecting bells and relays by zone.</p>	<p>Step 23 is used to select the relays and/or bells that you want to activate for particular conditions. This means that relays and/or bells programmed would activate when the specified conditions occurred in a zone.</p> <p><b>Digits 1-4 select relays. Digits 5-8 select bells.</b></p> <p>Step 23.1 selects relays/bells to activate for Pre-alarm conditions.            Step 23.2 selects relays/bells to activate for Tamper alarm conditions.            Step 23.3 selects relays/bells to activate for Special (Auxiliary) conditions.            Step 23.4 selects relays/bells to activate for Fire conditions.            Step 23.5 selects relays/bells to activate for Trouble conditions.            Step 23.6 selects relays/bells to activate for No Silence conditions.</p> <p><b>Example:</b> Use the steps below to program your system for the following:</p> <p><u>Pre-alarm condition:</u> Activate Relays 3 and 4 and Bell 1.  <u>Fire:</u> Activate Bells 1, 2, 3, and 4.  <u>Trouble condition:</u> Activate Relays 1 and 2 and Bells 1 and 2.</p> <p>1. Pre-alarm condition relays/bells are programmed in Step 23.1.</p> <ol style="list-style-type: none"> <li>a. Press <span style="border: 1px solid black; padding: 0 2px;">3</span> to select Relay 3</li> <li>b. Press <span style="border: 1px solid black; padding: 0 2px;">4</span> to select Relay 4</li> <li>c. Press <span style="border: 1px solid black; padding: 0 2px;">5</span> to select Bell 1</li> </ol> <p>Your LCD would appear as shown below:</p> <div data-bbox="873 1381 1182 1491" style="border: 1px solid black; padding: 5px; margin: 10px auto; width: fit-content;"> <p>23.1: GRP RLY --345---</p> </div> <p style="text-align: right;"><i>example continued on next page</i></p>



Display	Description
<p><i>Step 23 continued</i></p>	<p>2. Fire condition relays/bells are programmed in Step 23.4.</p> <ol style="list-style-type: none"> <li>Press <b>5</b> to select Bell 1</li> <li>Press <b>6</b> to select Bell 2</li> <li>Press <b>7</b> to select Bell 3</li> <li>Press <b>8</b> to select Bell 4</li> </ol> <p>Your LCD would appear as shown below:</p> <div style="border: 1px solid black; padding: 5px; width: fit-content; margin: 10px auto;"> <p>23.4: GRP RLY ----5678</p> </div> <p>3. Trouble condition relays/bells are programmed in Step 23.5.</p> <ol style="list-style-type: none"> <li>Press <b>1</b> to select Relay 1</li> <li>Press <b>2</b> to select Relay 2</li> <li>Press <b>5</b> to select Bell 1</li> <li>Press <b>6</b> to select Bell 2</li> </ol> <p>Your LCD would appear as shown below:</p> <div style="border: 1px solid black; padding: 5px; width: fit-content; margin: 10px auto;"> <p>23.5: GRP RLY 12--56--</p> </div>
<div style="border: 1px solid black; padding: 5px; width: fit-content;"> <p>23.1: GRP RLY -----</p> </div>	<p><b>Pre-Alarm Relays and Bells</b>                      1-4 = Relays that will activate during a pre-alarm condition.                      5-8 = Bells that will activate during a pre-alarm condition.</p> <p>Note: Relays or bells selected as Pre-alarm will not activate during a test.</p>
<div style="border: 1px solid black; padding: 5px; width: fit-content;"> <p>23.2: GRP RLY -----</p> </div>	<p><b>Tamper Alarm Relays and Bells</b>                      1-4 = Relays that will activate during a tamper alarm condition.                      5-8 = Bells that will activate during a tamper alarm condition.</p>
<div style="border: 1px solid black; padding: 5px; width: fit-content;"> <p>23.3: GRP RLY -----</p> </div>	<p><b>Special (Auxiliary) Alarm Relays and Bells</b>                      1-4 = Relays that will activate during a special alarm condition.                      5-8 = Bells that will activate during a special alarm condition.</p> <p>Note: If Sprinkler zone types are used, do not connect audible devices to Special Alarm relays.</p>
<div style="border: 1px solid black; padding: 5px; width: fit-content;"> <p>23.4: GRP RLY ----5678</p> </div>	<p><b>Fire Alarm Relays and Bells</b>                      1-4 = Relays that will activate during a fire alarm condition.                      5-8 = Bells that will activate during a fire alarm condition.</p>

Display	Description
<div style="border: 1px solid black; padding: 5px; width: fit-content;"> <p>23.5: GRP RLY</p> <p>1-----</p> </div>	<p><b>Trouble Relays and Bells</b></p> <p>1-4 = Relays that activate during a trouble condition.                      5-8 = Bells that activate during a trouble condition.</p> <p>Note: Relays or bells selected as Trouble will not activate during a test.</p>
<div style="border: 1px solid black; padding: 5px; width: fit-content;"> <p>23.6: GRP RLY</p> <p>-----</p> </div>	<p><b>No Silence Relays and Bells</b></p> <p>This option is intended for use with applications such as strobes.</p> <p>1-4 = Relays that will remain active when the 5207 is silenced. (Alarm relays always remain active until reset.)                      You can use this step to program a trouble relay to remain active after the panel is silenced. Select the relay that should remain active in this step.</p> <p>5-8 = Outputs that will remain active when the 5207 is silenced.                      You can use this step to make sure that strobes on the system continue to activate when bells and horns are silenced. To do this, make sure strobes are on separate outputs from horns and bells, then select the strobe outputs in this step.</p> <p>Note: If you are using the 5220 Direct Connect Module for supervision, see Section 4.7 for information on programming relays and bells.</p>

## Step 24. Alarm Relays and Bells (by Zone)

Display	Description
<div style="border: 1px solid black; padding: 5px; width: fit-content;"> <p>24.0: ZONE RLY</p> <p>-----</p> </div> <p>This step selects bells and relays to activate by zone. Step 23 is for selecting bells and relays by type of condition.</p>	<p>Use this step to select the relays and/or bells that will activate during an alarm condition in each zone. Step 24.0 selects bells and relays to activate during a fire drill ("Zone 0"). Step 24.1 selects bells and relays to activate for an alarm in Zone 1, Step 24.2 selects bells and relays for Zone 2, and so on.</p> <p>1-4 = Relays that will activate during an alarm in the zone.                      5-8 = Bells that will activate during an alarm in the zone.</p> <p>Note: If using the Model 5220 Direct Connect Module for supervision, select Relay 3 for Zone 3. See Section 4.7 for more information.</p>

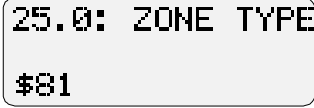
## Step 25. Zone Types

Display	Description
	<p>In Steps 25.1 through 25.16, you will program two numbers.</p> <p>Digit 1 programs the audible signals for the zone. Digit 2 programs the zone type.</p> <p>Move through the steps to make sure that all zones in your installation have been programmed the way you want them to be. For any zones that require changes, follow the steps for changing zone types as described in the examples above. You can record zone options in the Quick Reference chart in Section 6.</p> <p><b>Audible Signal (Step 25, Digit 1)</b></p> <ul style="list-style-type: none"> <li>0 = Bells can shut down</li> <li>2 = Cross alarm delay (alarm report delayed until a second alarm occurs on another zone)</li> <li>4 = No <i>manual</i> bell silence (waterflow zones)</li> <li>8 = No <i>automatic</i> bell shutdown (fire zones)</li> <li>A = Cross alarm and no shutdown. (Press <b>SHIFT</b> <b>1</b> for letter “A”.)</li> </ul> <p><b>Zone Types (Step 25, Digit 2)</b></p> <ul style="list-style-type: none"> <li>0 = Fire Drill</li> <li>1 = Fire (includes waterflow switches, smoke detectors, heat, etc.)</li> <li>3 = Panic</li> <li>5 = Tamper</li> <li>6 = Sprinkler (supervisory zones)</li> <li>7 = Undefined Auxiliary</li> <li>8 = Water (Auxiliary for high or low water)</li> <li>9 = Heat</li> <li>A = Cold (Press <b>SHIFT</b> <b>1</b> for letter “A”.)</li> <li>B = Local (not reported) (Press <b>SHIFT</b> <b>2</b> for letter “B”.)</li> <li>C = Not used. Do NOT select.</li> </ul> <p><b>Example 1:</b> Suppose you want Zone 1 to be a fire type zone with no automatic bell shutdown. At Step 25.1, make sure the digits “81,” the factory-programmed selections, are displayed. Press <b>8</b> <b>1</b> if necessary.</p> <p><b>Example 2:</b> Suppose you want Zone 2 to be a fire type zone with cross-alarm delayed and no bell shutdown. Press <b>SHIFT</b> <b>1</b> to select “A” for digit 1 (cross alarm and no shutdown). Press <b>1</b> for Digit 2 to select fire type. Your LCD would appear as shown below.</p> 



## Step 26. Zone Location Descriptions

Display	Description
<div style="border: 1px solid black; padding: 5px; width: fit-content;"> <p>26.1: WORDS</p> <p>1</p> </div>	<p><b>The following instructions explain how to select zone descriptions for the 5230 display.</b></p> <p>For Steps 26.1-26.16, the factory-programmed default is “WORDS” (“WORDS” appears on the LCD). You can choose one- or two-word descriptions for each zone from the 5207 word list (library) shown below.</p> <p>Note: You cannot customize the library using the 5230 annunciator. If you want to use words other than those contained in the library, you must use the 5541 downloading software.</p> <p>The step numbers correlate to zone numbers. For example, Step 26.1 is where you program a zone description for Zone 1, Step 26.2 is for Zone 2, and so on. Read the examples below to learn how to select zone descriptions.</p> <p><b>Example 1: Programming a One-Word Description</b>            Suppose you want to program Zone 3 to display "GARAGE."            At Step 26.3, press <input type="button" value="3"/> until the word "GARAGE" displays on the LCD.            Press <input type="button" value="ENTER"/> to select.</p> <p><b>Example 2: Programming a Two-Word Description</b>            Suppose you want to program Zone 5 to display "EAST OFFICE".            Because "EAST OFFICE " is a two-word display, an additional step is required.            At Step 26.5, press <input type="button" value="1"/> until you reach the word "EAST."            Press <input type="button" value="2"/> until you read the word "OFFICE."            Press <input type="button" value="ENTER"/> to select.</p>

**Table 6-1 Zone Description Words**

First Word		Second Word	
FRONT	HEAT	FLOOR	2ND FLR
BACK	FIRE	HALL	3RD FLR
NORTH	VALVE	ROOM	4TH FLR
SOUTH	WATERFLOW	OFFICE	WINDOW
EAST	SPRINKLER	DOOR	BATH
WEST	PULL STATION	VALVE	SAFE
LOBBY	1ST	SMOKE	GLASS
BASEMENT	2ND	HEAT	LEVEL
GARAGE	3RD	WATERFLOW	TEMP
WAREHOUSE	4TH	SPRINKLER	RM
MEZZANINE	WHSE	1ST FLR	DR
SMOKE			

## Steps 27 and 28. Temporal Patterns

Display	Description
<div data-bbox="272 359 586 470" style="border: 1px solid black; padding: 5px; margin-bottom: 10px;">                     27: TPL LENGTH 32                 </div> <p data-bbox="250 506 602 564">This step programs the length of the pattern.</p>	<p data-bbox="634 321 1414 415">Steps 27 and 28 are used together to control the temporal (pulsing) pattern of the bell outputs. You can use these steps to create any temporal pattern you want, including the pattern required by NFPA 72.</p> <p data-bbox="634 434 1414 527">Step 27 determines the length (number of bits) of the pattern. This number can be 1 to 32, allowing for patterns that are up to 16 seconds (or 32 half-seconds) in duration.</p> <p data-bbox="634 546 899 573">The default setting is 32.</p> <p data-bbox="634 592 1403 684">Note: If you are using this step to create a customized temporal pattern, both cadenced pulsing (option 0) and pulse fire bells (option 3) must be enabled in Step 3.</p> <p data-bbox="634 703 1081 730"><b>Example 1: Simple two-second pattern</b></p> <p data-bbox="634 737 1403 829">Suppose you want to create the simple temporal pattern one second ON, one second OFF. In Step 27, you would enter “4” because the length of the pattern is four half-seconds (or two seconds).</p> <p data-bbox="634 835 1362 894">After programming this example, your LCD would appear as shown below.</p> <div data-bbox="911 905 1138 978" style="border: 1px solid black; padding: 5px; margin: 10px auto; width: fit-content;">                     27 TPL LENGTH 4                 </div> <p data-bbox="634 989 1170 1016">See Example 1 in Step 28.1 for setting the pattern.</p> <p data-bbox="634 1035 1076 1062"><b>Example 2: NFPA 72 required pattern</b></p> <p data-bbox="634 1068 1385 1161">In an NFPA 72 installation, the temporal pattern must be ON OFF ON OFF ON OFF OFF OFF. Program Step 27 as shown below to achieve this pattern length.</p> <div data-bbox="899 1171 1154 1266" style="border: 1px solid black; padding: 5px; margin: 10px auto; width: fit-content;">                     27 TPL LENGTH 8                 </div> <p data-bbox="634 1276 1170 1304">See Example 2 in Step 28.1 for setting the pattern.</p>

Display	Description
<div data-bbox="277 306 583 411" style="border: 1px solid black; padding: 5px; margin-bottom: 10px;"> <p>28.1: TPL BITS 1234567-</p> </div> <p data-bbox="253 453 537 512">This step selects the actual pattern.</p>	<p data-bbox="634 264 1409 386">Steps 28.1-28.4 determine the pattern. Select a digit for each half-second ON; de-select a digit (display shows a dash) for each half-second OFF. Each sub-step controls up to four seconds. <b>The pattern you create will repeat as long as the bell output is active.</b></p> <p data-bbox="634 407 1154 434">The default setting is the 32-bit temporal pattern:</p> <p data-bbox="683 438 1045 466">ON ON ON ON ON ON ON OFF</p> <p data-bbox="683 470 1045 497">ON ON ON ON ON ON ON OFF</p> <p data-bbox="683 501 1045 529">ON ON ON ON ON ON ON OFF</p> <p data-bbox="683 533 1117 560">OFF OFF OFF OFF OFF OFF OFF</p> <p data-bbox="634 581 1273 609">If using the 5541, Y indicates ON and a dash indicates OFF.</p> <p data-bbox="634 630 1081 657"><b>Example 1: Simple two-second pattern</b></p> <p data-bbox="634 661 1393 751">To create the simple temporal pattern one second ON, one second OFF. In Step 28.1, you would select a digit for each half-second ON and de-select a digit for each half-second OFF as follows:</p> <div data-bbox="891 762 1338 900" style="border: 1px solid black; padding: 5px; margin: 10px auto; width: fit-content;"> <p>28.1 TPL BITS 12--56--</p> </div> <p data-bbox="716 921 1268 947" style="text-align: center;"> <span style="margin-right: 100px;">2 half-seconds ON</span> <span>2 half-seconds OFF</span> </p> <p data-bbox="634 951 1143 978">See Example 1 in Step 27 for setting the length.</p> <p data-bbox="634 982 1377 1073"><i>Note: If using this step to create a customized temporal pattern, both cadenced pulsing (option 0) and pulse fire bells (option 3) must be enabled in Step 3.</i></p> <p data-bbox="634 1094 1076 1121"><b>Example 2: NFPA 72 required pattern</b></p> <p data-bbox="634 1125 1403 1215">In an NFPA 72 installation, the temporal pattern must be ON OFF ON OFF ON OFF OFF OFF. Program Step 28.1 as shown below to achieve this pattern.</p> <div data-bbox="886 1226 1166 1331" style="border: 1px solid black; padding: 5px; margin: 10px auto; width: fit-content;"> <p>28.1: TPL BITS 1-3-5---</p> </div>



---

## Section 8

# Reporting

---

---

The following formats can be used to report to Silent Knight receivers and are explained further in this section:

- SIA
- FSK & SK 4+2
- 16 Zone 4+2
- Radionics BFSK

The following **Trouble Conditions** may generate a report to the central station:

- Low AC
- Low battery
- Loss of smoke detector power
- Loss of accessory power
- Supervised notification device trouble
- Earth ground fault
- Dialer trouble (Device 0)
- Annunciator trouble

### 8.1 Notes for All Formats

---

The 5207 can report to the formats described in the following sections. The following information applies to all formats:

1. The 5207 can hold up to 30 alarm events in its memory. If more events occur, the first event will be replaced with the message DATA LOST 01. Any older events will be replaced by newer events.
2. Momentary alarms will report a restore immediately if manually silenced by Alarm Reset.
3. Failure of the annunciator bus is not reported or printed, but an audible trouble tone will sound and the display will indicate the problem. The code F0 appears on the built-in touchpad display and the LCD reads "BUS TROUBLE".
4. When a fire drill is reset, it will not report an Open Reset.

## 8.2 SIA Format Printed Messages

The Security Industry Association (SIA) format can be used with a Silent Knight Model 9000 receiver. Each message is displayed in English followed by the zone number. Due to limited space on the 9000 display, some messages may be in abbreviated form.

Table 8-1 shows the information that is printed at the Silent Knight 9000 receiver when the SIA format is used for data transmission.

**Table 8-1: SIA Messages**

SIA Code	9000 Printer	5207 Status
YT0	LOW BATTERY 0	System battery is low.
YR0	BATTERY RESTORE 0	Battery voltage is back to normal.
AT0	AC TROUBLE 0	AC power is off or low.
AR0	AC RESTORE 0	AC power is back on.
LT1-2	PHONE LINE TROUBLE 1-2	Trouble on phone line (1 or 2).
LR1-2	PHONE LINE RESTORE 1-2	Phone line (1 or 2) back to normal.
ET0	EXPANSION TROUBLE 0	Dialer trouble.
ET1	EXPANSION TROUBLE 1	Printer trouble.
ET7	EXPANSION TROUBLE 7	EE memory trouble.
ET8	EXPANSION TROUBLE 8	XBUS trouble.
ET17-23	EXPANSION TROUBLE 17-23	Annunciator 1-7 trouble.
ET32-35	EXPANSION TROUBLE 32-35	Notification device 1-4 trouble.
ET36	EXPANSION TROUBLE 36	Smoke power trouble.
ET37	EXPANSION TROUBLE 37	Accessory power trouble.
ET38	EXPANSION TROUBLE 38	Earth ground fault to circuit ground.
ET39	EXPANSION TROUBLE 39	Earth ground fault to power.
ER0	EXPANSION RESTORE 0	Dialer back to normal.
ER1	EXPANSION RESTORE 1	Printer back to normal.
ER7	EXPANSION RESTORE 7	EE memory back to normal.
ER8	EXPANSION RESTORE 8	XBUS back to normal.
ER17-23	EXPANSION RESTORE 17-23	Annunciator 1-7 back to normal.
ER32-35	EXPANSION RESTORE 32-35	Notification device 1-4 back to normal.
ER36	EXPANSION RESTORE 36	Smoke power back to normal.
ER37	EXPANSION RESTORE 37	Accessory power back to normal.
ER38	EXPANSION RESTORE 38	Circuit ground earth fault removed.
ER39	EXPANSION RESTORE 39	Power earth ground fault removed.
OR0-99	OPEN RESET ALARM ID 0-99	Alarm reset by access code 0 - 99.
FA1-16	FIRE ALARM 1-16	Alarm in fire zone 1-16.
FT1-16	FIRE TROUBLE 1-16	Trouble condition in fire zone 1-16.
FB1-16	FIRE BYPASS 1-16	Zone 1-16 has been bypassed.
FR1-16	FIRE RESTORE 1-16	Alarm or trouble restore in zone 1-16.
FU1-16	FIRE UNBYPASS 1-16	Zone (1-16) that was disabled has been restored.
PA1-16	PANIC ALARM 1-16	Alarm in panic zone 1-16.
PT1-16	PANIC TROUBLE 1-16	Trouble condition in panic zone 1-16.
PB1-16	PANIC BYPASS 1-16	Zone 1-16 has been bypassed.
PR1-16	PANIC RESTORE 1-16	Alarm or trouble restore in zone 1-16.
PU1-16	PANIC UNBYPASS 1-16	Zone (1-16) that was disabled has been restored.

Table 8-1: SIA Messages

SIA Code	9000 Printer	5207 Status
TA1-16	TAMPER ALARM 1-16	Alarm in tamper zone 1-16.
TT1-16	TAMPER TROUBLE 1-16	Trouble condition in tamper zone 1-16.
TB1-16	TAMPER BYPASS 1-16	Zone 1-16 has been bypassed.
TR1-16	TAMPER RESTORE 1-16	Alarm or trouble restore in zone 1-16.
TU1-16	TAMPER UNBYPASS 1-16	Zone (1-16) that was disabled has been restored.
SA1-16	SPRINKLER ALARM 1-16	Alarm in sprinkler zone 1-16.
ST1-16	SPRINKLER TROUBLE 1-16	Trouble condition in sprinkler zone 1-16.
SB1-16	SPRINKLER BYPASS 1-16	Zone 1-16 has been bypassed.
SR1-16	SPRINKLER RESTORE 1-16	Alarm or trouble restore in zone 1-16.
SU1-16	SPRINKLER UNBYPASS 1-16	Zone (1-16) that was disabled has been restored.
UA1-16	UNDEFINED ALARM 1-16	Alarm in auxiliary zone 1-16.
UT1-16	UNDEFINED TROUBLE 1-16	Trouble condition in auxiliary zone 1-16.
UB1-16	UNDEFINED BYPASS 1-16	Zone 1-16 has been bypassed.
UR1-16	UNDEFINED RESTORE 1-16	Alarm or trouble restore in zone 1-16.
UU1-16	UNDEFINED UNBYPASS 1-16	Zone (1-16) that was disabled has been restored.
WA1-16	WATER ALARM 1-16	Alarm in water zone 1-16.
WT1-16	WATER TROUBLE 1-16	Trouble condition in water zone 1-16.
WB1-16	WATER BYPASS 1-16	Zone 1-16 has been bypassed.
WR1-16	WATER RESTORE 1-16	Alarm or trouble restore in zone 1-16.
WU1-16	WATER RESTORE 1-16	Zone (1-16) that was disabled has been restored.
KA1-16	HEAT ALARM 1-16	Alarm in heat zone 1-16.
KT1-16	HEAT TROUBLE 1-16	Trouble condition in heat zone 1-16.
KB1-16	HEAT BYPASS 1-16	Zone 1-16 has been bypassed.
KR1-16	HEAT RESTORE 1-16	Alarm or trouble restore in zone 1-16.
KU1-16	HEAT RESTORE 1-16	Zone (1-16) that was disabled has been restored.
ZA1-16	COLD ALARM 1-16	Alarm in cold zone 1-16.
ZT1-16	COLD TROUBLE 1-16	Trouble condition in cold zone 1-16.
ZB1-16	COLD BYPASS 1-16	Zone 1-16 has been bypassed.
ZR1-16	COLD RESTORE 1-16	Alarm or trouble restore in zone 1-16.
ZU1-16	COLD RESTORE 1-16	Zone (1-16) that was disabled has been restored.
RP0	AUTO TEST 0	Automatic dialer test occurred.
RX0-1	MANUAL TEST 0-1	System tested by access code 0 or 1.
RX2-99	MANUAL TEST (2-99)	System tested by access code 2-99.
RT0	DATA LOST 0	Previous event could not be reported and the information was lost.
RS0	REMOTE PROG. PASS	Data has been downloaded successful.
RU0	REMOTE PROG. FAIL	Problem with downloading; data transfer did not occur.
FX00	FIRE DRILL	Fire drill

## 8.3 FSK & SK 4+2 Format

You must use either the FSK or SK 4+2 format when reporting to the Silent Knight Model 8520 Receiver. Since the 8520 has only two digits for alarm codes, event type and zone numbers are combined into one message. The first digit of the code is the type of report, the second digit is the last number of the zone.

### Example:

Any two-digit code beginning with the digit 0 is a fire alarm.

Code 01 = Fire alarm in zone 1 or 11

Code 05 = Fire alarm in zone 5 or 15

If you selected the 16-zone report option at Step 14.5 of Step Programming (Section 2 of the 5207 programming manual), the above information does not apply to you. Zone numbers will report as 1 - 16. See for more information.

The 4+2 format repeats after 10.

**Table 8-2: FSK and SK 4+2 Codes/Zones**

FSK and 4+2	Description
<b>Y=Last digit of the user ID number. Z=last number of the zone.</b>	
<b>Fire Codes</b>	
0Z	Alarm
20	Disable Restore (Fire type zones report as 20)
50	Disable Zone (Fire type zones report as 50)
6Z	Supervisory or Trouble
7Z	Alarm Restore, Supervisory Restore, and Trouble Restore
<b>Other Zones</b>	
30	Dialer Test, Walk Test, Fire Drill
31	Phone Line 1 Trouble
32	Phone Line 2 Trouble
*33	Expansion Trouble (see Note below)
35	Phone Line 1 Restore
36	Phone Line 2 Restore
*37	Expansion Restore (see Note below)
39	Data Lost
60	AC Lost
69	Low Battery
70	AC Restore
79	Battery Restore
9Y	Reset Alarm by Code #

*\*Note: Expansion refers to all the expansion troubles and restores listed in the SIA format (Section 8.2).*



## 8.4 16-Zone 4+2 Format

When \*selected, the FSK1 and SK 4+2 formats will send alarms on zones 1 through 16 as 01-16. All 16 zones have unique alarm codes. However, there are some limitations. Zone troubles and restores cannot be completely distinguished from alarms. Zones 9 and 10 share some codes with battery and AC supervision. Table 8-3 shows which codes will be reported when the 16-zone 4+2 format is used. (The codes that will be reported if this option is not selected appear in Table 8-2.)

**\*Important:** In order to use this format, you must select “8” in programming step 14.5.

**Table 8-3: 16-Zone 4+2 Format**

Zone	Code	Description
Alarm Zone 1	01	ALARM 1
...		...
Alarm Zone 8	08	ALARM 8
Alarm Zone 9	09	ALARM 9
Alarm Zone 10	10	ALARM 10
Alarm Zone 11	11	ALARM 11
...		...
Alarm Zone 16	16	ALARM 16
Trouble Zone 1	61	TROUBLE 1
...		...
Trouble Zone 8	68	TROUBLE 8
Trouble Zone 9	69	TROUBLE 9
Trouble Zone 10	60	TROUBLE 10
Trouble Zone 11	61	TROUBLE 11
...		...
Trouble Zone 16	66	TROUBLE 16
Restore Zone 1	71	RESTORE 1
...		...
Restore Zone 8	78	RESTORE 8
Restore Zone 9	79	RESTORE 9
Restore Zone 10	20	RESTORE 10
Restore Zone 11	21	RESTORE 11
...		...
Restore Zone 16	26	RESTORE 16

## 8.5 Radionics BFSK Format

Model 5207 can transmit using the Radionics BFSK format with 1400 Hz or 2300 Hz acknowledge. The messages that will be printed are listed with the codes for FSK1 and SK 4+2.

Radionics BFSK format can only report eight zone codes. Zones 9 through 16 report as zones 1 through 8; zones 17 through 24 report as zones 1 through 8, and so on. Because of this limitation, programming the 5207 to report in both the Radionics BFSK and either the FSK or SK 4+2 formats is NOT advised. Use only if required by the receiver.

The Radionics BFSK format repeats after 8. It is recommended that you use no more than 8 zones if your system is programmed to report in Radionics BFSK format. However, if you choose to use more than 8 zones with the Radionics BFSK format, it is a good idea to make every 8th zone (such as Fire, Tamper Sprinkler, etc.) the same zone type (such as Fire). If you assign the zones in this manner, the letter X in will be a digit that represents every 8th zone number, as shown below:

Digit Reported (X)	1	2	3	4	5	6	7	8
Zone Numbers	1	2	3	4	5	6	7	8
	9	10	11	12	13	14	15	16
	17	18	19	...				

**Table 8-4: Radionics BFSK**

BFSK	Radionics BFSK	Description
<b>Fire Codes</b>		
X	Alarm Zone X	Alarm on zone X (see chart above for actual number).
E0	Restore Zone 0	Disable restore zone 0.
F0	Trouble Zone 0 was Forced Armed	Trouble zone 0 (zone disabled).
FX	Trouble Zone X	Trouble zone X (see chart above page for actual number).
EX	Restore Zone X	Alarm or trouble restore zone X (see chart above for actual number).
<b>Other Zones</b>		
E9	Restore Zone 9	Test/restore zone 9.
FB	Trouble Zone B	Phone line fault
*FC	Trouble Zone C	Expansion trouble (see Note below)
EB	Restore Zone B	Phone line trouble restore.
*EC	Restore Zone C	Expansion restore (see Note below)
E9	Test/restore Zone 9	Data lost.
F0	Trouble Zone 0.	AC lost.
F9	Trouble Zone 9.	Low battery.
E0	Restore Zone 0.	AC restore.
E9	Restore zone 9	Battery restore.
BY	Open zone (Code #)	Reset alarm by user code #.

Note: "Expansion" refers to all expansion trouble/restores listed in SIA format, Table 8-1.

---

# Section 9

## Troubleshooting

---

---

### 9.1 Problems With the Model 5198 Power Supply

---

If you experience problems with the power supply, use the troubleshooting techniques described in the following sections. There are separate procedures for 12-volt and 24-volt power supplies.

The following display messages indicate that the power supply and panel voltage selections are not the same: A1, A2, A3, A4, P1, P2. See programming step 2 (Section 7).

#### 9.1.1 Isolating the Problem

Use this procedure to test the power supply to make sure that it is the device that is causing a problem.

Remove the power supply connector (P1) from the 5207 board. Disconnect the battery from the power supply. Make all power supply measurements with 120 VAC applied to the power supply.

Place a 4.7k resistor between pins 1 (brown) and 3 (orange). Use a DC voltmeter set to the 50V range to measure the voltage across the resistor. The voltage reading should be between 26 and 28 volts. Remove all power from the power supply before replacing connector P1 on the panel.

#### 9.1.2 Measuring Battery Charging Voltage

The power supply puts batteries in series for you. Measure from the negative of one set of cables to the positive of the other set. One combination should read 0V; the other combination should read between 27.3-27.5.

## 9.2 P3 and P4 Earth Ground Faults

A P3 trouble indicates that the panel has detected a short between earth ground (terminal 52) and circuit ground (terminals 1, 10, 20, 25).

A P4 trouble indicates that the panel has detected a short between any power source and earth ground. Some common power sources are terminals 12, 15, 18, 24, 26, 28, 30, 32, 34 or the batteries.

To determine the location of the short, place a DC volt meter with ground on terminal 1 and positive on terminal 52. The meter should be continuously fluctuating between 0 and 2.5 volts DC. Remove and leave off field wiring from the panel until the meter reads in this range. You can also use Accu-Zone® Troubleshooting to determine the location (see Section 9.3).

## 9.3 Accu-Zone® Troubleshooting (Mode 25)

Accu-Zone® Troubleshooting allows you to locate shorts and other system troubles (including AC power and battery power) without using a voltmeter. All alarms and troubles are disabled while you are using Mode 25 allowing you to trip sensors, adjust wiring, and so on. You must use the Model 5230 Remote Annunciator for Accu-Zone troubleshooting (see Table 9-1).

To enter troubleshooting mode:	Press <b>[2][5][ENTER]</b> + Code 0 or 1. The first line of the display will show the default channel number (3). (See Figure 9-1 for an example.) Press <b>[ENTER]</b> if you want to view information for channel 3.
To move sequentially through the channels:	Press <b>[ENTER]</b> until you arrive at the channel you want to view.
To skip to a different step:	Enter the number of the channel you want to view and press <b>[ENTER]</b> . Channel numbers and the inputs they represent are shown in Table 9-1.
To exit troubleshooting mode:	Press <b>[CLEAR][CLEAR]</b> .

### 9.3.1 Mode 25 Display

The first line of the display will show the channel (input) number followed by six digits known as “step numbers”. Although the step numbers are not actual voltage readings, they can identify any voltage fluctuations that may have occurred.

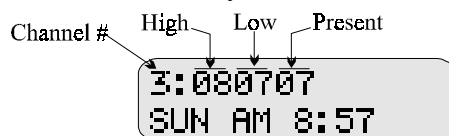

Figure 9-1 Mode 25 Display

When you momentarily put a zone into alarm, the touchpad will display the Present (current) value along with the High (spikes) and Low (voltage drop) values. This is also useful in locating intermittent connections.

Step numbers range from 0 to 16. Using Table 9-1, you can determine if the step numbers are within the acceptable range for each input.

**Table 9-1 Significance of Mode 25 Readings**

Input	Term. #	Chan. #	Typical Reading	Significance
Zone 1 Class A (style D)	3	17	11	In normal condition, the following is true: 1) Terminals 3 and 4 are the same; AND 2) Terminal 2 and 5 are the same; AND 3) Terminals 3 and 4 are not the same as 2 and 5. If any of the conditions is not true, it indicates an alarm or trouble condition.
	4	18	11	
	2	19	6	
	5	20	6	
Zone 2 Class A (style D)	7	21	11	In normal condition, the following is true: 1) Terms. 7 and 8 are the same AND 2) Terms. 6 and 9 are the same AND 3) Terms. 7 and 8 are not the same as 6 and 9. If any of the conditions is not true, it indicates an alarm or trouble condition.
	8	22	11	
	6	23	6	
	9	24	6	
Zones 3-8 Class B (style B)	11-19	3-8	8-9	Above 10 = Alarm Below 6 = Trouble
Zones 9-16 Class B (style B)	(5210)	9-16	8-9	Above 10 = Alarm Below 6 = Trouble
Accessory Power	26	30	6-7	Above 8 = Trouble Below 4 = Trouble
Earth Ground	52	31	1-9	Fluctuates continuously from 1-9 in normal condition.
Notif. Circuits 1-4	27-34	25-28	10-11	Above 12 = Trouble Below 8 = Trouble
Smoke Power	12, 15, 18	29	11-12	Above 12 = Trouble Below 8 = Trouble

## 9.4 Troubleshooting and System Messages

Table 9-2 shows the messages that may appear on the Model 5230 Touchpad display and the codes that may appear on the 5207 built-in touchpad display.

For troubleshooting, you can connect a 5230 temporarily if it is not part of the installation (see 4.9.2).

**Table 9-2 System Messages and Codes**

5230 Annunciator	Built-in Annunciator Display / LEDs	Explanation
System messages.	1-	Alarm reset. Alarm reset code is being entered on the annunciator.
System messages.	2-	Alarm memory has been cleared.
System messages.	3-	Dialer being reset.
0 ENTER	0- Set Mode LED is on.	Fire drill or system test in progress.
*CALLING COMPUTER	-4	Data is being up- or downloaded.
DATA LOST	DL	Most common reason for this message is that the communicator has lost data that was being transmitted to the central station.  (This message could also indicate that alarm memory buffer is full. Press <b>2</b> <b>ENTER</b> + code to clear.)
FAILED	DF	Dialer failed. The communicator has failed to report.
*REPORTING	Set Time LED flashes	An event is being reported to the central station.
Prompts for input.	-7 Set Mode LED is on.	The 5207 is in Step Programming mode.
System data.	-5 Set Mode LED is on.	A zone test is in progress.
XXXX ALARM yy	-n (n= zone number)	The alarm memory is being displayed. XXXX = Alarm type YY = Zone number
ALARM ZONE 1-16	1-16 ALARM LED: Flashing = Fire Steady on = supervisory	Alarm in the indicated zone. If more than one zone is in alarm, the top line of the 5230 will cycle through the status messages for each zone.
BAD EEPROM 5230 piezo sounds on and off.	E7 LEDs and 5207 piezo turn on and off.	Problem with EEPROM. Replace chip.

*\*When the transmission is completed, the 5230 annunciator resets and displays its ID.*

**Table 9-2 System Messages and Codes**

5230 Annunciator	Built-in Annunciator Display / LEDs	Explanation
DISABLED: ZONE # ZONE DESCRIPTION	Panel beeps. Press <b>DISABLE</b> to see bypassed zone. (Cannot be silenced until zone is restored.)	Disabled zone. (Zone descriptions appear only if selected during programming.)
NORMAL	--	No trouble, alarm, or other condition exists.
y XX SEC TO ALARM Y=Prealarm zone number XX=countdown (seconds)	Number of zone in pre-alarm.	An alarm condition exists in the indicated zone but will not sound and report an alarm until the pre-alarm time has elapsed. During prealarm, pressing <b>RESET ALARM</b> <b>ENTER</b> + Code will prevent sounding and reporting.
BUS TROUBLE	No display.	Annunciator data wires are shorted or reversed.
SILENCED	SILENCE LED is on.	A trouble condition exists and has been silenced.
SMOKE ZONE #	1-16	Smoke verification time, zone 1-16.
SPRINKLER ALARM X	1-16	Sprinkler supervisory alarm. X = zone number.
TIME?	-9 SET MODE LED is on.	The 5207 is in Set Time mode.
TROUBLE: X	1-16	Sprinkler supervisory trouble. X = zone number.
TROUBLE: KEYSTATION n	F0 Trouble LED on	A 5230 annunciators is in trouble.
TROUBLE: AC	AC TROUBLE LED flashes.	AC power has been lost. Check connection to AC power source.
TROUBLE: BATTERY	DC TROUBLE LED on.	Battery power has been lost, or polarity has been reversed. Measure the battery voltage and replace the battery or reverse polarity as needed.
TROUBLE: BELL X	A1 - A4 TROUBLE LED on.	A trouble condition exists on the indicated notification circuit. X = bell number.
TROUBLE: POWER 3	P3 and P4 TROUBLE LED	1. An earth to circuit ground fault condition exists. Use Mode 25 to locate and correct the condition. 2. Earth ground shorted to power. Use Mode 25 to locate and correct the problem.
TROUBLE: LINE #	L1 or L2	A trouble condition exists on indicated phone line.
TROUBLE ZONE X	1-16 TROUBLE LED is on.	A trouble condition exists in the indicated zone. See Section 9.3 for more information about correcting trouble conditions. (X = zone number)

**Table 9-2 System Messages and Codes**

<b>5230 Annunciator</b>	<b>Built-in Annunciator Display / LEDs</b>	<b>Explanation</b>
TRY AGAIN	--	A keystroke error has been made. Press <input type="button" value="CLEAR"/> and enter the correct keystrokes.
WALK TEST SUN AM 12:19	-2 SET MODE LED is on.	A walk test is being conducted. The top line of the 5230 display may also show the zone number in a trouble condition.



# Appendix A

## Compatible Devices

This section of the manual lists devices (smoke detectors and notification appliances) that are compatible with the 5207. Contact Silent Knight if you have a question about whether a device not listed here is compatible.

### A.1 Smoke Detectors

This section of the manual contains information about smoke detectors that are compatible with the 5207.

	<b>5207</b>	<b>5210</b>
<b>Identifier</b>	24D	24A
<b>Voltage Range</b>	19.4-28 VDC	17.8-27.4 VDC

*Notes:*

*The maximum number of smoke detectors per zone is determined by both the current draw and the impedance of the smoke detector. If too many smoke detectors are used on any zone, false alarms could occur.*

*Do not mix different models of detectors on any zone; false alarms could occur.*

*Control unit Smoke Reset Time must be programmed for a number greater than or equal to the maximum reset time of the smoke detector.*

#### Two-Wire Smoke Detectors

The table below lists two-wire smoke detectors that are compatible with the 5207. The table is organized by manufacturer. Information for both 12V and 24V mode and for the 5210 Zone Expander Module is included. The columns show the number of detectors per loop that can be used.

<b>Manufacturer</b>	<b>Model Name or Number</b> <i>(Base model name or number in parentheses.)</i>	<b>5207</b>	<b>5210</b>
Apollo	55000-250 (45681-200)	24 / loop	8 / loop
Apollo	55000-350 (45681-200)	24 / loop	8 / loop
Detection Systems	DS200 (MB200-2W)	24 / loop	12 / loop
Detection Systems	DS200HD (MB200-2W)	24 / loop	12 / loop
Detection Systems	DS250 (MB2W or MB2WL)	18 / loop	8 / loop
Detection Systems	DS250HD (MB2W or MB2WL)	18 / loop	8 / loop
Detection Systems	DS250TH (MB2W or MB2WL)	18 / loop	8 / loop
ESL	425	40 / loop	20 / loop
ESL	425C	40 / loop	20 / loop
ESL	425CR	40 / loop	20 / loop
ESL	425CRT	40 / loop	20 / loop
ESL	425CT	40 / loop	20 / loop
ESL	429C (S10A)	30 / loop	14 / loop
ESL	429CRT (S11A)	30 / loop	14 / loop

<b>Manufacturer</b>	<b>Model Name or Number</b> <i>(Base model name or number in parentheses.)</i>	<b>5207</b>	<b>5210</b>
ESL	429CST (S11A)	30 / loop	14 / loop
ESL	429CT (S10A)	30 / loop	14 / loop
ESL	609U01-11	40 / loop	24 / loop
ESL	609U02-11	40 / loop	24 / loop
ESL	611U (601U or 602U)	40 / loop	24 / loop
ESL	611UD (601U or 602U)	40 / loop	24 / loop
ESL	611UT (601U or 602U)	40 / loop	24 / loop
ESL	612U (601U or 602U)	40 / loop	24 / loop
ESL	612UD (601U or 602U)	40 / loop	24 / loop
ESL	711U (701E or 701U)	25 / loop	15 / loop
ESL	712U (701E or 701U)	25 / loop	15 / loop
ESL	713-5U (702E or 701U)	25 / loop	15 / loop
ESL	713-6U (702E or 701U)	25 / loop	15 / loop
ESL	721-U (S10A)	30 / loop	15 / loop
ESL	721-UT (S10A)	30 / loop	15 / loop
Falcon	525	17 / loop	8 / loop
Falcon	525T	17 / loop	8 / loop
Faraday	9374	20 / loop	10 / loop
Faraday	9375	20 / loop	10 / loop
Faraday	9376	20 / loop	10 / loop
Hochiki	SIH-24F (HS-224D or HSB-224)	25 / loop	10 / loop
Hochiki	SLK-12	25 / loop	10 / loop
Hochiki	SLK-24F (HS-224D)	25 / loop	10 / loop
Hochiki	SLK-24FH (HS-224D)	25 / loop	10 / loop
Hochiki	(HS224L) Heat Detector base	30 / loop	30 / loop
System Sensor	1100	20 / loop	8 / loop
System Sensor	1100T	20 / loop	8 / loop
System Sensor	1100TB	20 / loop	8 / loop
System Sensor	1151 (110LP)	20 / loop	8 / loop
System Sensor	1400	20 / loop	8 / loop
System Sensor	1451 (B401B)	20 / loop	8 / loop
System Sensor	1800	20 / loop	8 / loop
System Sensor	1851B (B101B)	20 / loop	8 / loop
System Sensor	1851DH (DH1851DC)	20 / loop	8 / loop
System Sensor	2100	20 / loop	8 / loop
System Sensor	2100T	20 / loop	8 / loop
System Sensor	2100TB	20 / loop	8 / loop
System Sensor	2151 (B110LP or B110LRP)	20 / loop	8 / loop
System Sensor	2300T	20 / loop	8 / loop
System Sensor	2400	20 / loop	8 / loop
System Sensor	2400 (DH400)	20 / loop	8 / loop
System Sensor	2400AIT	20 / loop	8 / loop
System Sensor	2400AT	20 / loop	8 / loop
System Sensor	2400TH	20 / loop	8 / loop

<b>Manufacturer</b>	<b>Model Name or Number</b> <i>(Base model name or number in parentheses.)</i>	<b>5207</b>	<b>5210</b>
System Sensor	2451 (B401B)	20 / loop	8 / loop
System Sensor	2451DH (DH 400)	20 / loop	8 / loop
System Sensor	2451TH (B401B)	20 / loop	8 / loop
System Sensor	2800	20 / loop	8 / loop
System Sensor	2800TH	20 / loop	8 / loop
System Sensor	2851B (B101B)	20 / loop	8 / loop
System Sensor	2851BTH (B101B)	20 / loop	8 / loop
System Sensor	2851DH	20 / loop	8 / loop
System Sensor	2851TH (B101B)	20 / loop	8 / loop

### Four Wire Smoke Detectors

<b>Manufacturer</b>	<b>Model</b>
Silent Knight	SD-P24F with SD-B4@ base
Detection Systems	DS200/DS200HD MB200
ESL	445 Series 449 Series
System Sensor	1851B 2851/2851BTH DH200ADCD

## A.2 Notification Appliances

The chart below lists notification appliances compatible with the 5207.

<b>Manufacturer</b>	<b>Model</b>	<b>Type</b>
Faraday	446X 12/24VDC	Vibrating Bell
Faraday	476X 12/24VDC	Vibrating Bell
Faraday	477X 12/24VDC	Single Stroke Bell
Faraday	5303B-0-14-( )-DC	Chime (flush)
Faraday	5304B-0-14-( )-DC	Chime (surface)
Faraday	5305B-0-4-( )-DC	Chime (ceiling)
Faraday	5306B-0-14-( )-24-DC	Chime/Strobe (flush)
Faraday	5307B-0-14-( )-24-DC	Chime/Strobe (surface)
Faraday	5308B-0-4-( )-24-DC	Chime/Strobe (ceiling)
Faraday	5333B-0-14-24-DC	Multi-Tone Horn (flush)
Faraday	5334B-0-14-24-DC	Multi-Tone Horn (surface)
Faraday	5336B-( )-14-24-DC	Multi-Tone Horn/Strobe (flush)
Faraday	5337B-( )-14-24-DC	Multi-Tone Horn/Strobe (surface)
Faraday	5338B-( )-4-24-DC	Multi-Tone Horn/Strobe (ceiling)
Faraday	5343B-0-14-24-DC	Single Tone Horn/Strobe (flush)
Faraday	5344B-0-14-24-DC	Single Tone Horn/Strobe (surface)
Faraday	5345B-0-4-24-DC	Single Tone Horn/Strobe (ceiling)
Faraday	5348B-( )-4-24-DC	Single Tone Horn/Strobe (ceiling)

<b>Manufacturer</b>	<b>Model</b>	<b>Type</b>
Faraday	5373B-0-14-24-DC	8-Tone Horn/Strobe (flush)
Faraday	5374B-0-14-24-DC	8-Tone Horn/Strobe (surface)
Faraday	5375B-0-4-24-DC	8-Tone Horn/Strobe (ceiling)
Faraday	5376B-0-14-24-DC	8-Tone Horn/Strobe (flush)
Faraday	5377B-0-14-24-DC	8-Tone Horn/Strobe (surface)
Faraday	5378B-0-4-24-DC	8-Tone Horn/Strobe (ceiling)
Faraday	5405B-0-14-24-DC	Sync Control Unit
Faraday	5508B-( )-14-24-DC	Single Gang Sync Strobe (flush)
Faraday	5521B-( )-14-24-DC	4" Square Sync Strobe (surface)
Faraday	5522B-( )-14-24-DC	4" Square Sync Strobe (flush)
Faraday	6126B-U-14-24 VDC	Horn/Strobe
Faraday	6223B-0-14-24-DC	Horn (flush)
Faraday	6224B-0-14-24-DC	Horn (surface)
Faraday	6225B-0-4-24-DC	Horn (ceiling)
Faraday	6226B-( )-14-24-DC	Horn/Strobe (flush)
Faraday	6227B-( )-14-24-DC	Horn/Strobe (surface)
Faraday	6228B-( )-4-24-DC	Horn/Strobe (ceiling)
Faraday	6243B-0-14-24-DC	Electron-Mechanical Horn (flush)
Faraday	6244B-0-14-24-DC	Electron-Mechanical Horn (surface)
Faraday	6245B-0-4-24-DC	Electron-Mechanical Horn (ceiling)
Faraday	6246B-( )-14-24-DC	Electron-Mechanical Horn/Strobe (flush)
Faraday	6247B-( )-14-24-DC	Electron-Mechanical Horn/Strobe (surface)
Faraday	6248B-( )-4-24-DC	Electron-Mechanical Horn/Strobe (ceiling)
Faraday	6300B-0-14-24-DC	Mini-Horn (flush)
Faraday	6301B-0-14-24-DC	Mini-Horn (surface)
Faraday	6302B-( )-4-24-DC	Mini-Horn (ceiling)
Faraday	6310B-0-14-24-DC	Mini-Horn/Strobe/Strobe (flush)
Faraday	6311B-0-14-24-DC	Mini-Horn/Strobe/Strobe (surface)
Faraday	6312B-( )-14-24-DC	Mini-Horn/Strobe/Strobe (ceiling)
Faraday	6320B-0-14-24-DC	Sync Mini Horn/Strobe (1 gang)
Faraday	6321B-0-14-24-DC	Sync Mini Horn/Strobe (1,2 gang)
Faraday	6322B-( )-14-24-DC	Mini Horn/Sync Strobe (1,2 gang, 4SQ)
Federal Signal	450	Horn
Federal Signal	VALS	Horn/Strobe
Gentex	GX90-4	Horn
Gentex	GXS-4-15-1	Strobe
Gentex	GXS-4-1575	Strobe
Gentex	GX90S-4-15	Horn
Gentex	GX90S-4-1575	Horn
Gentex	HG124	Horn
Gentex	SHG24-1575	Horn/Strobe
Gentex	SHG24-15	Horn/Strobe
Gentex	GMH-24-X	Horn

<b>Manufacturer</b>	<b>Model</b>	<b>Type</b>
Gentex	GMS-24-X	Horn/Strobe
Gentex	GMS-24-X	Horn/Strobe
Gentex	G0T24	Horn
Gentex	G0S24-X	Horn
Gentex	WGMS-24-X	Horn/Strobe
System Sensor	MASS241	Horn/Strobe
System Sensor	MASS24110ADA	Horn/Strobe
System Sensor	MASS2415ADA	Horn/Strobe
System Sensor	MASS2475ADA	Horn/Strobe
System Sensor	SS4110ADA	Strobe
System Sensor	SS2415ADA	Strobe
System Sensor	SS2475ADA	Strobe
System Sensor	PS2415ADA	Mini-Horn/Strobe
System Sensor	PS241575ADA	Mini-Horn/Strobe
System Sensor	PS24110ADA	Mini-Horn/Strobe
System Sensor	PS2475ADA	Mini-Horn/Strobe
Wheelock	46T-G4-24-R	Bell
Wheelock	46T-G6-24-R	Bell
Wheelock	46T-G10-24-R	Bell
Wheelock	46T-G6-24-WS-24-HF-R	Strobe/Bell
Wheelock	46T-G10-24-WS-24-HF-R	Strobe/Bell
Wheelock	46T-G6-24-WH-24-HF-R	Strobe/Bell
Wheelock	46T-G10-24-WH-24-HF-R	Strobe/Bell
Wheelock	700IT-12\24-W-FR	Strobe Horn
Wheelock	7002T-12\24-W-FR	Strobe Horn
Wheelock	AES-DL1-R	Multitone Horn
Wheelock	AES-EL1-R	Multitone Horn
Wheelock	AES-DL1-WS-24-VF-R	Multitone Horn
Wheelock	AES-EL1-WS-24-VF-R	Multitone Horn
Wheelock	AES-DL1-WH-24-VF-R	Multitone Horn
Wheelock	AES-EL1-WH-24-VF-R	Multitone Horn
Wheelock	AES-DL1-WM-24-VF-R	Multitone Horn
Wheelock	AES-EL1-WM-24-VF-R	Multitone Horn
Wheelock	AH-24-R	Horn
Wheelock	AMT-12\24-R	Strobe Horn
Wheelock	AMT-24-LS-VFR	Strobe Horn
Wheelock	AMT-24-LSM-VFR	Strobe Horn
Wheelock	AMT-24-IS-VFR	Strobe Horn
Wheelock	AS-2415-VFR	Strobe Horn
Wheelock	AS-241575-VFR	Strobe Horn
Wheelock	AS-2430-VFR	Strobe Horn
Wheelock	AS-2475-VFR	Strobe Horn
Wheelock	AS-24110-HFR	Strobe Horn
Wheelock	SM-12\24-R	Strobe Horn Controller
Wheelock	DSM-12\24-R	Strobe Horn Controller

<b>Manufacturer</b>	<b>Model</b>	<b>Type</b>
Wheelock	CF-BF1	Chime
Wheelock	CF-BF1-R	Chime
Wheelock	CH-CF1	Chime
Wheelock	CH-CF1-R	Chime
Wheelock	CH-CF1-W	Chime
Wheelock	CH-DF1	Chime
Wheelock	CH-DF1-R	Chime
Wheelock	CH-BF1-WS-24-HF-R	Strobe Chime
Wheelock	CH-CF1-LS-24	Strobe Chime
Wheelock	CH-CF1-MS-24	Strobe Chime
Wheelock	CH-CF1-IS-24	Strobe Chime
Wheelock	CH-CF1-LS-24-CFW	Strobe Chime
Wheelock	CH-CF1-MS-24-CFW	Strobe Chime
Wheelock	CH-CF1-IS-24-CFW	Strobe Chime
Wheelock	CH-CF1-WS-24-CF-W	Strobe Chime
Wheelock	CH-DF1-LS-24	Strobe Chime
Wheelock	CH-DF1-MS-24	Strobe Chime
Wheelock	CH-DF1-IS-24	Strobe Chime
Wheelock	CH-DF1-LS-24-VFR	Strobe Chime
Wheelock	CH-DF1-LSM-24-VFR	Strobe Chime
Wheelock	CH-DF1-MS-24-VFR	Strobe Chime
Wheelock	CH-DF1-IS-24-VFR	Strobe Chime
Wheelock	CH-DF1-WM-24-VFR	Strobe Chime
Wheelock	CH-DF1-WS-24-VF-R	Strobe Chime
Wheelock	DSM-12/24	Sync Module
Wheelock	EH-DL1-R	Electronic Horn
Wheelock	EH-EL1-R Electronic Horn	Electronic Horn
Wheelock	EHS-DL1-W-VF-R	Strobe Horn (single input)
Wheelock	EHS-EL1-W-VF-R	Strobe Horn (single input)
Wheelock	EH-DL1-WS-24-VF-R	Strobe Horn (dual input)
Wheelock	EH-EL1-WS-24-VF-R	Strobe Horn (dual input)
Wheelock	EH-DL1-WH-24-VF-R	Strobe Horn (dual input)
Wheelock	EH-EL1-WH-24-VF-R	Strobe Horn (dual input)
Wheelock	EH-DL1-WM-24-VF-R	Strobe Horn (dual input)
Wheelock	EH-EL1-WM-24-VF-R	Strobe Horn (dual input)
Wheelock	HSW-24-HFR	Remote Strobe
Wheelock	HS2W-24-HFR	Remote Strobe
Wheelock	HSPW-24-HFR	Remote Strobe
Wheelock	IS-24-VFR	Remote Strobe
Wheelock	IS1-24-VFR	Remote Strobe
Wheelock	IS3-24-VFR	Remote Strobe
Wheelock	ISP-24-HFR	Remote Strobe
Wheelock	LS-24-VFR	Remote Strobe
Wheelock	LS1-24-VFR	Remote Strobe
Wheelock	LS3-24-VFR	Remote Strobe

<b>Manufacturer</b>	<b>Model</b>	<b>Type</b>
Wheelock	LSP-24-HFR	Remote Strobe
Wheelock	LSM-24-VFR	Remote Strobe
Wheelock	LS1M-24-VFR	Remote Strobe
Wheelock	LS3M-24-VFR	Remote Strobe
Wheelock	LSPM-24-VFR	Remote Strobe
Wheelock	MS-24-VFR	Remote Strobe
Wheelock	MS1-24-VFR	Remote Strobe
Wheelock	MS3-24-VFR	Remote Strobe
Wheelock	MSP-24-HFR	Remote Strobe
Wheelock	MB-G6-24-R	Motor Bell
Wheelock	MB-G10-24-R	Motor Bell
Wheelock	MBS-G6-24-W-HF-R	Motor Bell with Strobe
Wheelock	MBS-G10-24-W-HF-R	Motor Bell with Strobe
Wheelock	MIZ-24-R	Mini-Horn
Wheelock	MIZ-24-W	Mini-Horn
Wheelock	MIZ-24-LS-VFR	Mini-Horn/Strobe
Wheelock	MIZ-24-LSM-VFR	Mini-Horn/Strobe
Wheelock	MIZ-24-MS-VFR	Mini-Horn/Strobe
Wheelock	MIZ-24-HSW-HFR	Mini-Horn/Strobe
Wheelock	MIZ-24-IS-VFR	Mini-Horn/Strobe
Wheelock	MIZ-24-WS-VF-R	Mini-Horn/Strobe
Wheelock	MIZ-24-WS-VF-W	Mini-Horn/Strobe
Wheelock	MIZ-24-WH-VF-W	Mini-Horn/Strobe
Wheelock	MIZ-24-WM-VF-W	Mini-Horn/Strobe
Wheelock	MT-12/24-R	Strobe Horn
Wheelock	MT-24-LS-VFR	Strobe Horn
Wheelock	MT-24-LSM-VFR	Strobe Horn
Wheelock	MT-24-MS-VFR	Strobe Horn
Wheelock	MT-24-IS-VFR	Strobe Horn
Wheelock	MT-24-SL-VFR	Strobe Horn
Wheelock	MT-24-SLM-VFR	Synch. Multitone Strobe
Wheelock	MT-24-WM	Strobe
Wheelock	MT-24-WM-VF-R	Horn
Wheelock	MT-24-WM-VFR	Horn
Wheelock	RS-2415-HFR	Strobe
Wheelock	RSP-2415-VFR	Strobe
Wheelock	RS-241575-VFR	Strobe
Wheelock	RSP-241575-VFR	Strobe
Wheelock	RS-2430-VFR	Strobe
Wheelock	RS-2430-HFR	Strobe
Wheelock	RS-2475-VFR	Strobe
Wheelock	RSP-2475-HFR	Strobe
Wheelock	RS-24110-HFR	Strobe
Wheelock	RSP-24110-HFR	Strobe
Wheelock	SL-24-VFR	Synchronized Remote Strobe

<b>Manufacturer</b>	<b>Model</b>	<b>Type</b>
Wheelock	SL1-24-VFR	Synchronized Remote Strobe
Wheelock	SL3-24-VFR	Synchronized Remote Strobe
Wheelock	SLP-24-VFR	Synchronized Remote Strobe
Wheelock	SLM-24-VFR	Synchronized Remote Strobe
Wheelock	SL1M-24-VFR	Synchronized Remote Strobe
Wheelock	SL3M-24-VFR	Synchronized Remote Strobe
Wheelock	SLPM-24-VFR	Synchronized Remote Strobe
Wheelock	SHW-24-VFR	Synchronized Remote Strobe
Wheelock	SH2W-24-VFR	Synchronized Remote Strobe
Wheelock	SHPW-24-VFR	Synchronized Remote Strobe
Wheelock	SCM-24-R	Controller for Synchronized Strobes
Wheelock	SM-12/24-R	Sync Module
Wheelock	SR-2415-VFR	Sync Strobe
Wheelock	SRP-2415-HFR	Sync Strobe
Wheelock	SR-241575-VFR	Sync Strobe
Wheelock	SRP-241575-VFR	Sync Strobe
Wheelock	SR-2475-VFR	Sync Strobe
Wheelock	SR-2475-HFR	Sync Strobe
Wheelock	SR-24110-HFR	Sync Strobe
Wheelock	SRP-24110-HFR	Sync Strobe
Wheelock	V700IT-12\24-W-FR	Strobe Horn
Wheelock	WM3T-24-FR	Remote Strobe
Wheelock	WM3T-24-VFR	Remote Strobe
Wheelock	WSIT-24-FR	Strobe
Wheelock	WS3T-24-FR	Strobe
Wheelock	WST-24-FR	Strobe