
Content

Section 1

Introduction 1-1

- 1.1 Overview of Basic System 1-1
 - 1.1.1 Hardware Features 1-1
 - 1.1.2 Software Features 1-2
- 1.2 About this Manual 1-2
 - 1.2.1 Terms Used in this Manual 1-2
- 1.3 Compatible Products 1-3
- 1.4 How to Contact Silent Knight 1-4

Section 2

Agency Listings, Approvals, and Requirements 2-1

- 2.1 Federal Communications Commission (FCC) 2-1
- 2.2 Underwriters Laboratories (UL) 2-2
 - 2.2.1 Requirements for All Installations 2-2
 - 2.2.2 Requirements for Central Station Fire Alarm Systems 2-2
 - 2.2.3 Requirements for Local Protected Fire Alarm Systems 2-2
 - 2.2.4 Requirements for Remote Station Protected Fire Alarm Systems - Digital Alarm Communicator Transmitter (DACT) 2-2

Section 3

Before You Begin Installing 3-1

- 3.1 What's in the Box? 3-1
- 3.2 Environmental Specifications 3-1
- 3.3 Electrical Specifications 3-2
- 3.4 Wiring Specifications 3-3
- 3.5 Board Assembly Diagram 3-5
- 3.6 Calculating Current Draw and Standby Battery 3-6
 - 3.6.1 Worksheet Requirements 3-6
 - Filling in the Current Draw Worksheet, Table 3-2 (Section 3.6.2) 3-6
 - 3.6.2 Current Draw Worksheet 3-7
 - 3.6.2.1 Maximum Battery Standby Load 3-8
- 3.7 Installation Tasks Overview 3-9

Section 4

Control Panel Installation 4-1

- 4.1 Mounting the Control Panel Cabinet 4-1
 - 4.1.1 Removing the 5820XL Assembly from the Housing 4-1
- 4.2 AC Connection 4-2
- 4.3 Battery Connection 4-3

4.3.1	AB-33 Accessory Cabinet	4-4
4.3.1.1	Installing the AB-33 Accessory Cabinet and Batteries	4-4
4.4	SBUS Wiring	4-6
4.4.1	Calculating Wiring distance for SBUS modules	4-6
	Wiring Distance calculation example:	4-8
4.4.2	Wiring Configurations	4-9
4.5	Remote Annunciator 5860 Installation	4-10
4.5.1	Mounting the 5860	4-11
4.5.1.1	Flush Mounting	4-12
	Flush Mounting with an Electrical Box	4-13
	Flush Mounting Steps	4-13
4.5.1.2	Surface Mounting	4-14
4.5.2	Model 5860 Connection to the Panel	4-15
4.6	5815XL Installation	4-16
4.6.1	5815XL Connection to the Panel	4-17
4.7	5824 Serial/Parallel Interface Installation	4-18
4.7.1	Selecting 5824 Options	4-19
	Printer and Output Port Options	4-20
4.8	5880 LED Driver Module	4-21
4.8.1	5880 Board Layout	4-21
4.8.2	FACP Connection	4-22
4.8.3	LED Wiring	4-23
4.8.4	Dry Contact Wiring	4-24
4.9	5865-3 / 5865-4 LED Annunciator Installation	4-25
4.9.1	FACP Connection	4-26
4.9.2	5865 Mounting	4-27
4.10	Configuring Modules	4-28
4.10.1	Assigning Module IDs	4-28
4.11	Telephone Connection	4-29
4.11.1	Ground Start Relay (Model 5211)	4-29
4.12	Flexputs™ I/O Circuits	4-30
4.12.1	Conventional Notification Appliance	4-30
4.12.1.1	Class B Notification Wiring	4-30
4.12.1.2	Class A Notification Wiring	4-31
4.12.2	Conventional Input Switch Circuits	4-32
4.12.2.1	Class B Inputs	4-32
4.12.2.2	Class A Inputs	4-33
4.12.3	Installing 2-Wire Smoke Detectors	4-34
4.12.3.1	Installing 2-Wire Class B Smoke Detectors	4-34
4.12.3.2	Installing 2-Wire Class A Smoke Detector	4-35
4.12.4	Installing 4-Wire Smoke Detectors	4-36
4.12.4.1	Installing a Class B 4-Wire Smoke Detector	4-36
4.12.4.2	Installing 4-Wire Class A Smoke Detectors	4-37
4.12.5	Auxiliary Power Installation	4-38
4.12.5.1	Door Holder Power	4-38
4.12.5.2	Constant Power	4-38
4.12.5.3	Resettable Power	4-39
4.13	On-Board Relays (Conventional)	4-39
4.13.1	Trouble Relay	4-39
4.13.2	Programmable Relays	4-39
4.14	Keltron Model 3158 Installation	4-40
4.15	Model 5220 Direct Connect Module	4-41
4.15.1	5220 Electrical Specifications	4-41
4.15.2	City Box Connection	4-42
4.15.3	NFPA 72 Polarity Reversal	4-43

Section 5 SLC Device Installation 5-1

5.1	Types of SLC Devices	5-1
5.2	Maximum Number of Devices	5-1
5.3	Wiring Requirements for SLC Devices	5-2
5.3.1	Wiring 5815XL in Style 4 (Class B) Configuration	5-2
5.3.2	Wiring 5815XL in Style 6 (Class A) Configuration	5-3
5.4	Heat and Smoke Detector Installation	5-4
5.4.1	Wiring	5-4
5.5	Duct Detector Installation	5-5
5.6	Input Monitor Module (SD500-AIM)	5-6
5.7	Mini Input Module (SD500-MIM)	5-7
5.8	Relay Module Installation	5-8
5.8.1	Electrical Specifications	5-8
	Relay Ratings	5-8
5.8.2	Wiring	5-8
5.9	SD500-ANM Installation Instructions	5-9
5.9.1	SD500-ANM Specification	5-9
5.9.2	Wiring the SD500-ANM	5-10
5.9.2.1	Wiring the SD500-ANM to the 5815XL	5-10
5.9.3	Class B Notification Configuration	5-10
5.9.4	Class A Notification Configuration	5-11
5.9.5	Configuring Flexput™ Circuits for Auxiliary Power	5-11
5.10	SLC Device Addressing	5-12
5.10.1	EEPROM Addressing	5-12
5.10.2	Dipswitch Addressing	5-13

Section 6 Programming Overview 6-1

6.1	JumpStart Autoprogramming	6-1
6.1.1	Input Points	6-2
6.1.2	Output Points	6-2
6.1.3	Running JumpStart	6-2
6.2	Mapping Overview	6-4
6.2.1	Input Point Mapping	6-5
6.2.2	Output Circuit Mapping	6-6
6.2.3	Zone Event Mapping	6-7
6.2.4	Mapping LED Points	6-9
6.3	SK Analog Fire System Editor 5590	6-10
6.4	Annunciator Programming	6-10
6.4.1	Entering / Exiting the Program Menu	6-11
	To enter the Program Mode:	6-11
	To Exit Program Mode:	6-11
6.4.2	Moving through the Menus	6-12
6.4.3	Selecting Options and Entering Data	6-12
6.4.4	Editing Keys	6-13
6.5	Programming Menu Quick Reference	6-14

Section 7

Programming 7-1

7.1	Modules	7-1
7.1.1	Edit Modules	7-1
7.1.1.1	Naming Modules	7-2
7.1.1.2	Module, Wiring Class	7-2
7.1.2	Adding a Module	7-2
7.1.3	Deleting a Module	7-3
7.2	Zone	7-4
7.2.1	Edit Zone	7-4
7.2.1.1	Edit Zone Name	7-5
7.2.1.2	Edit Zone Properties	7-5
	Alarm Delay Characteristics	7-6
	Heat Detector Sensitivity	7-7
	Smoke Detector Sensitivity	7-7
7.2.1.3	Zone Outputs	7-8
	Mapping to Zone Events	7-8
	Example or Zone Mapping:	7-9
7.2.1.4	Cadence Patterns	7-10
7.2.2	Add Zone	7-11
7.2.3	Delete Zone	7-11
7.2.4	View Zone Points	7-12
7.3	Group	7-13
7.3.1	Edit Group	7-13
7.3.1.1	Edit Group Name	7-13
	Example of Group Name:	7-14
7.3.1.2	Edit Group Properties	7-14
	Latching / Non-latching Outputs	7-14
	Silencing Options	7-15
	Response with System-Wide Conditions	7-15
7.3.2	Add Group	7-16
7.3.3	Delete Group	7-16
7.3.4	View Group Points	7-17
7.3.5	Edit Output Group Templates	7-18
7.4	Point	7-19
7.4.1	Point Programming For 5815XL Module	7-19
7.4.2	Point Programming For Internal or External Power Module (5895XL) 7-22	
7.4.3	Point Programming For 5880 and 5865 Modules	7-24
7.4.3.1	Assigning a Name to a Points	7-25
7.5	System Options	7-26
7.5.1	Reporting Account	7-26
7.5.1.1	Edit Accounts	7-27
	Select Account (ID)	7-27
	Edit Account Number	7-27
	Select Reporting Format	7-28
	Events to Report	7-28
	Switch Attempts	7-28
	Fail Attempts	7-29
	Selecting Primary and Secondary Phone Lines	7-29
	Telephone Number	7-29
7.5.1.2	Auto Test Time	7-30
7.5.2	Phone Lines	7-30

7.5.2.1	Dialing Prefix	7-31
7.5.2.2	Number of Answer Rings	7-31
7.5.2.3	Dial Option (TouchTone or Pulse)	7-32
7.5.2.4	Rotary Format	7-32
7.5.2.5	Line Monitor	7-32
7.5.2.6	Ground Start Relay	7-32
7.5.2.7	Answering Machine Bypass	7-33
7.5.3	Sys. Event Outputs	7-33
7.5.3.1	Trouble Events	7-33
7.5.3.2	System Alarm Cadence	7-34
7.5.4	Day/Night Sensitivity Time	7-35
7.5.5	Holiday Days	7-36
7.5.6	Miscellaneous Options	7-37
7.5.6.1	Water Flow Delay	7-37
7.5.6.2	Low AC Report Delay	7-38
7.5.6.3	Automatic Daylight Savings Adjustment	7-38
7.5.6.4	Clock Display Format (AM/PM or Military)	7-38
7.5.6.5	Change AC Line Frequency	7-39
7.5.7	Edit Library Name	7-39
7.5.8	Edit Banner Message	7-40
7.6	JumpStart Autoprogramming	7-41
7.7	Computer Account	7-42
7.8	Access Codes	7-43

Section 8

System Operation 8-1

8.1	Annunciator Description	8-1
8.1.1	LCD Displays	8-1
8.1.2	Banner	8-2
8.2	Key Operation	8-2
8.3	Menu System	8-2
8.3.1	User Menu	8-3
8.3.2	Installer Menu	8-3
8.3.3	Main Menu Overview (User and Installer)	8-3
8.3.4	Using the Menus	8-4
8.4	Basic Operation	8-4
8.4.1	Setting Time and Date	8-4
8.4.2	Disable / Enable a Point	8-4
8.4.3	View Event History	8-4
8.4.4	Conduct a Fire Drill	8-5
8.4.5	Conduct an Indicator Test	8-5
8.4.6	Conduct a Walk Test	8-6
8.4.7	Conduct a Dialer Test	8-6
8.4.8	Silence alarms or troubles	8-6
8.4.9	Reset alarms	8-7
8.4.10	Check Detector Sensitivity Through Point Status	8-7
8.4.11	Change User or Installer Code	8-8
8.4.12	View Status of a Point	8-8
8.4.13	View Alarms or Troubles	8-8
8.4.14	View System Information	8-8
8.4.15	Reset dialer	8-8
8.4.16	Communicating with a Remote Computer	8-9
8.4.17	Working with a Printer	8-10
8.5	Operation Mode Behavior	8-11

Section 9
Reporting 9-1

- 9.1 Receivers Compatible with the Control Panel 9-1
- 9.2 Ademco Contact ID Dialer Output 9-2
- 9.3 SIA Dialer Output 9-6

Section 10
Testing and Troubleshooting 10-1

- 10.1 Troubleshooting 10-1
- 10.2 Common Problems 10-1
 - 10.2.1 Event History 10-2
- 10.3 Built-in Troubleshooting and Testing Tools 10-3
 - 10.3.1 SLC Device Locator 10-3
 - 10.3.2 SLC Multi Locator 10-4
 - 10.3.3 I/O Point Control 10-5

Section 11
Installation Records 11-1

- 11.1 SLC Point Record 11-1
- 11.2 Conventional Output Point Record 11-6

Appendix A
Compatible Devices A-1

- A.1 Two-Wire Smoke Detectors A-1
- A.2 Four-Wire Smoke Detectors A-2
- A.3 Notification Appliances A-3
- A.4 Door Holder Device A-10

Appendix B
Word and Special Characters Lists B-1

- B.1 Name Library B-1
- B.2 Characters For Customized Textual Descriptions B-2

Section 1

Introduction

The IntelliKnight 5820XL Fire Alarm Control / Communicator is an analog addressable fire control system that meets the requirements of UL 864.

1.1 Overview of Basic System

The IntelliKnight 5820XL base system is packaged as an assembled stack of 3 circuit boards mounted to an aluminum housing.

1.1.1 Hardware Features

- The basic IntelliKnight 5820XL panel contains one SLC (Signaling Line Circuit) which supports 127 analog addressable devices (points). Additional loops can be added using the Model 5815XL SLC Expander to increase overall point capacity to 381 points (127 points per 5815XL).
- 5.0A of output power is available through 6 sets of terminals for notification and auxiliary applications. Each circuit is power limited per UL 864 and can source up to 3.0A (total output power for all 6 circuits must not exceed 5.0A).
- Built-in dual phone line, digital alarm communicator/transmitter (DACT).
- Dedicated Form C trouble relay.
- Two general purpose Form C programmable relays.
- Basic system operation can be performed using a key or a user code.
- Can be used with up to 8 Model 5860 Remote Annunciators (sold separately).
- Can be used with Model 5865-3, 5865-4, and 5880 in any combination for a total of eight devices on one control panel. See Sections 4.8 and 4.9 for additional information on these models.
- Printing of detector status, event history, and real time event log available through the Model 5824 Serial / Parallel Interface (sold separately).
- Supports conventional 2-wire & 4-wire detectors using the 6 Flexput™ circuits.
- Add 6 Flexput™ circuits with each 5895 Intelligent Power Module (up to 8 5895s per system).
- 125 software zones, 250 output groups.

1.1.2 Software Features

- Advanced analog smoke detector features:
 - Three sensitivity settings (high, medium, low)
 - Automatic drift compensation
 - Maintenance alert region
 - Point status eliminates calibrated smoke test requirements for NFPA 72
 - Automatic day/night sensitivity adjustment
- “JumpStart” feature for easy programming
- Non-volatile event history stores 1000 events
- A choice of output patterns available for notification outputs, including ANSI 3.41 temporal signal

1.2 About this Manual

This manual is intended to be a complete reference for all installation and operation tasks. Please let us know if the manual does not meet your needs in any way. We value your feedback!

1.2.1 Terms Used in this Manual

The following terminology is used with the IntelliKnight 5820XL system:

Term	Description
SLC	Signaling Line Circuit
Module	The term module is used for all hardware devices except for SLC addressable devices and notification appliances. This includes the 5820XL panel itself and the built-in 5897 power supply. It also refers to any (optional) 5815XL SLC expansion modules.
Input Point	An addressable sensing device, such as a smoke or heat detector or a contact monitor device.
Input Zone	A protected area made up of input points.
Output Point (or Output Circuit)	A notification point or circuit for notification appliances. Relay circuits and auxiliary power circuits are also considered output points.
Group (or “Output Group”)	A group of output points. Operating characteristics are common to all output points in the group.
Output (or “Cadence”) Pattern	The pattern that the output will use, for example, Constant, March Code, ANSI 3.41. Applies to zones and special system events. See Section 7.5.3.2 for additional information.
Mapping	Mapping is the process of specifying which outputs are activated when certain events occur in the system. Section 6.2 explains mapping in detail.

1.3 Compatible Products

The chart below lists the products available from Silent Knight for use with the IntelliKnight 5820XL.

Model	Description
SLC Devices	
SD500-AIM	Contact Monitor Module (switch input). Standard size. (This device replaces Model SD500-FRCM-4. See Note below.)
SD500-MIM	Mini Contact Monitor Module (switch input). Small size. (This device replaces Model SD500-FRCM. See Note below.)
SD500-ARM	Relay Module (This device replaces Model SD505-ARM. See Note below.)
SD505-AHS	Heat Sensor
SD505-AIS	Ionization Smoke Detector
SD505-APS	Photoelectric Smoke Detector
SD505-ADH Duct housing is shipped with a detector base only. Detector head must be ordered separately.	Duct Housing for use with SD505-AIS ionization smoke detector or SD505-APS photoelectric smoke detector head. Intake tubing for duct available in 3 lengths: STS-2.5: Duct widths 1.0' to 2.5' STS-2.5: Duct widths 2.5' to 5.0' STS-2.5: Duct widths 5.0' to 10.0' When ordering SD505-ADH, specify intake tubing size and order the appropriate smoke detector, if needed.
SD500-ANM	Addressable Notification Module
Other Modules	
5815XL SLC Expander	Allows an additional 127 SLC devices to be added to the system. Up to two 5815XLs per system.
5211 Ground Start Relay	For use with ground start telephone network. (Do not use in UL installations.)
5824 Serial/Parallel Interface	Allows a printer to be attached for the system for on-site event logging, detector status and event history reports. Two maximum per system.
5895 Intelligent Power Module	Provides additional power, six Flexput™ circuits, and two Form C relays. Max. 8 per system see <i>Model 5895 Installation Instructions P/N 151024</i> .
5860 and 5860R Remote Fire Alarm Annunciator	Same operation, similar appearance as on-board annunciator. Up to 8 5860s per system. 5860 is gray; 5860R is red.
5860TG and 5860TR Trim Ring Kit	Trim ring kits for surface mounting the 5860 annunciator. 5860TG is gray; 5860TR is red.
5865-3 and 5865-4 LED Annunciator	LED annunciator can display up to 30 LEDs (15 red and 15 yellow). 5865-4 has key switches for silence and reset, and a system trouble LED.
5880 LED Driver Module	Driver for up to 40 LEDs. Interfaces with customized annunciator boards. In addition the 5880 has eight generic switch input points.
7860 Telephone Cord	RJ31X cord for connecting phone line to the 5820XL.
SK Analog Fire System Editor 5590	For communication and panel programming with a Windows-based computer and *modem (not sold by Silent Knight, see Table 1-1 for compatible modems). Enables remote viewing of detector status and event history.
IntelliView Software	For remote viewing of detector status and event history. Requires a modem (not sold by Silent Knight).

Note: Models SD500-FRCM, SD500-FRCM-4 and SD505-ARM are no longer manufactured, but they are still compatible with the IntelliKnight system. Contact Silent Knight if you need information about these modules.

5865-3, 5865-4, and 5880 can be used in any combination, up to a total of eight devices on one panel.

The following modems have been tested by Silent Knight for compatibility with the 5820XL and the 5590/IntelliView communication software packages:

Table 1-1: Compatible Modems

Manufacturer	Model
US Robotics	28.8
Motorola	LifeStyle
	28.8, 3400 series
	Premier 33.6
MultiTech	MT19321ZDX

1.4 How to Contact Silent Knight

If you have a question or encounter a problem not covered in this manual, contact Silent Knight Technical Support at 800-328-0103 (or 612-493-6455). To order parts, contact Silent Knight Sales at 800-446-6444 (or 612-493-6435).

IntelliKnight® is a registered trademarks of Silent Knight.

Flexput™ is a trademark of Silent Knight.

Section 2

Agency Listings, Approvals, and Requirements

2.1 Federal Communications Commission (FCC)

1. The following information must be provided to the telephone company before the IntelliKnight 5820XL can be connected to the phone lines:

A	Manufacturer:	Silent Knight Security Systems
B	Model Number:	IntelliKnight 5820XL
C	FCC registration number:	AC6USA-23901-AL-E
	Ringer equivalence:	0.8B
D	Type of jack:	RJ31X
E	Facility Interface Codes:	Loop Start: 02LS2 Ground Start: 02GS2
F	Service Order Code:	9.0F

2. This device may not be directly connected to coin telephone or party line services.
3. This device cannot be adjusted or repaired in the field. In case of trouble with the device, notify the installing company or return to:

Silent Knight Security Systems
7550 Meridian Circle
Maple Grove, MN 55369-4927
612-493-6455
800-328-0103

4. If the 5820XL causes harm to the telephone network, the telephone company will notify the user in advance that temporary discontinuance of service may be required. If advance notice is not practical, the telephone company will notify the user as soon as possible. Users have the right to file complaints, if necessary, with the Federal Communications Commission.
5. The telephone company may make changes in its facilities, equipment, operations, or procedures that could affect the operation of the equipment. If this happens, the telephone company will provide advance notice to allow you to make the necessary modifications to maintain uninterrupted service.

Warning

This device has been verified to comply with FCC Rules Part 15. Operation is subject to the following conditions: (1) This device may not cause radio interference, and (2) This device must accept any interference received, including interference that may cause undesired operation.

2.2 Underwriters Laboratories (UL)

2.2.1 Requirements for All Installations

General requirements are described in this section. When installing an individual device, refer to the specific section of the manual for additional requirements. The following subsections list specific requirements for each type of installation (for example, Central Station Fire Alarm systems, Local Protected Fire Alarm systems, and so on).

1. All field wiring must be installed in accordance with NFPA 70 National Electric Code.
2. Use the addressable smoke detectors specified in Section 5.1 of this manual and or conventional detectors listed in the compatibility chart. (See Appendix A.)
3. Use UL listed notification appliances compatible with the 5820XL from those specified in the *Appendix* at the back of this manual.
4. A full system checkout must be performed any time the panel is programmed.

2.2.2 Requirements for Central Station Fire Alarm Systems

1. Use both phone lines. Enable phone line monitors for both lines.
2. You must program a phone number and a test time so that the 5820XL sends an automatic daily test to the central station.
3. Do not use the ground start option.
4. The AC Loss Hours option must be set from 6-12 hours.
5. The Attempts to Report option must be set for 5.

2.2.3 Requirements for Local Protected Fire Alarm Systems

At least one UL listed supervised notification appliance must be used.

2.2.4 Requirements for Remote Station Protected Fire Alarm Systems - Digital Alarm Communicator Transmitter (DACT)

1. Do not exceed the current load restrictions shown in Section 3.6.
2. The AC Loss Hours option must be set from 15-30 hours.

Section 3

Before You Begin Installing

This section of the manual is intended to help you plan your tasks to facilitate a smooth installation. Please read this section thoroughly, especially if you are installing a 5820XL panel for the first time.

3.1 What's in the Box?

The IntelliKnight 5820XL ships with the following hardware:

- A cabinet with all hardware assembled
- Two keys for the front door
- Two keys for user operation of the on-board annunciator (installer operations require the Installer's Code)
- Ten 4.7K ohm end-of-line resistors
- A battery cable for batteries wired in series
- Programming adapter cable used for setting SLC device addresses

3.2 Environmental Specifications

It is important to protect the 5820XL control panel from water. To prevent water damage, the following conditions should be AVOIDED when installing the units:

- Do not mount directly on exterior walls, especially masonry walls (condensation)
- Do not mount directly on exterior walls below grade (condensation)
- Protect from plumbing leaks
- Protect from splash caused by sprinkler system inspection ports
- Do not mount in areas with humidity-generating equipment (such as dryers, production machinery)

When selecting a location to mount the 5820XL control panel, the unit should be mounted where it will NOT be exposed to temperatures outside the range of 0°C-49°C (32°F-120°F) or humidity outside the range of 10%-85% at 30°C (86°F) noncondensing.

3.3 Electrical Specifications

Table 3-1: Terminal Strip Description and Electrical Rating

Terminal # and Label		Description	Rating		
			Voltage	Current	
1	L	AC input (hot)	120 VAC, 60 Hz	2.5 A	
2		Earth ground	N/A	N/A	
3	N	AC input (neutral)	120 VAC 60 Hz	2.5 A	
4	X	I/O 6	Flexput™ Circuits	24 VDC	3.0 Amp Notification and Aux power Circuits
5	O				
6	X	I/O 5	Flexput™ Circuits	24 VDC	3.0 Amp Notification and Aux power Circuits
7	O				
8	X	I/O 4	Flexput™ Circuits	24 VDC	3.0 Amp Notification and Aux power Circuits
9	O				
10	X	I/O 3	Flexput™ Circuits	24 VDC	3.0 Amp Notification and Aux power Circuits
11	O				
12	X	I/O 2	Flexput™ Circuits	24 VDC	3.0 Amp Notification and Aux power Circuits
13	O				
14	X	I/O 1	Flexput™ Circuits	24 VDC	3.0 Amp Notification and Aux power Circuits
15	O				
16	B	SBUS OUT	SBUS communication	5 VDC	100 mA
17	A				
18	+		SBUS power	24 VDC	1.0 A
19	-				
20	B	SBUS IN	Used for Class A installations		
21	A				
22	+				
23	-				
24	N.C.	RELAY 2	General Purpose Relay 2	24 VDC	2.5 A
25	C				
26	N.O.				
27	N.C.	RELAY 1	General Purpose Relay 1	24 VDC	2.5 A
28	C				
29	N.O.				
30	N.C.	TROUBLE	Trouble Relay	24 VDC	2.5 A
31	C				
32	N.O.				

Table 3-1: Terminal Strip Description and Electrical Rating

Terminal # and Label			Description	Rating	
				Voltage	Current
33	SC-	L1	SLC terminals	32 VDC	150 mA
34	SC+	SLC OUT			
35	SC-	L2	Used for Class A installations		
36	SC+	SLC IN			
37	Ring		Phone Line 1 Telco Ring	N/A	
38	Tip		Phone Line 1 Telco Tip		
39	Ring		Phone Line 1 Premises Ring		
40	Tip		Phone Line 1 Premises Tip		
41	Ring		Phone Line 2 Telco Ring	N/A	
42	Tip		Phone Line 2 Telco Tip		
43	Ring		Phone Line 2 Premises Ring		
44	Tip		Phone Line 2 Premises Tip		
45	SC-		SLC Programming Terminal (-)	32 VDC	150 mA
46	SC+		SLC Programming Terminal (+)	32 VDC	150 mA

3.4 Wiring Specifications

Induced noise (transfer of electrical energy from one wire to another) can interfere with telephone communication or cause false alarms. To avoid induced noise, follow these guidelines:

- Isolate input wiring from high current output and power wiring. Do not pull one multi-conductor cable for the entire panel. Instead, separate the wiring as follows:

High voltage	AC power, Terminals 1-3
SLC loops	Terminals 33-36
Audio input/output	Phone line circuits, Terminals 37-44
Notification circuits	Terminals 4-15
SBUS	Terminals 16-23
Relay circuits	Terminals 24-32

- Do not pull wires from different groups through the same conduit. If you must run them together, do so for as short a distance as possible or use shielded cable. Connect the shield to earth ground at the panel. You must route high and low voltages separately.
- Route the wiring around the inside perimeter of the cabinet. It should not cross the circuit board where it could induce noise into the sensitive microelectronics or pick up unwanted RF noise from the high speed circuits. See Figure 3-1 for an example.
- High frequency noise, such as that produced by the inductive reactance of a speaker or bell, can also be reduced by running the wire through ferrite shield beads or by wrapping it around a ferrite toroid.

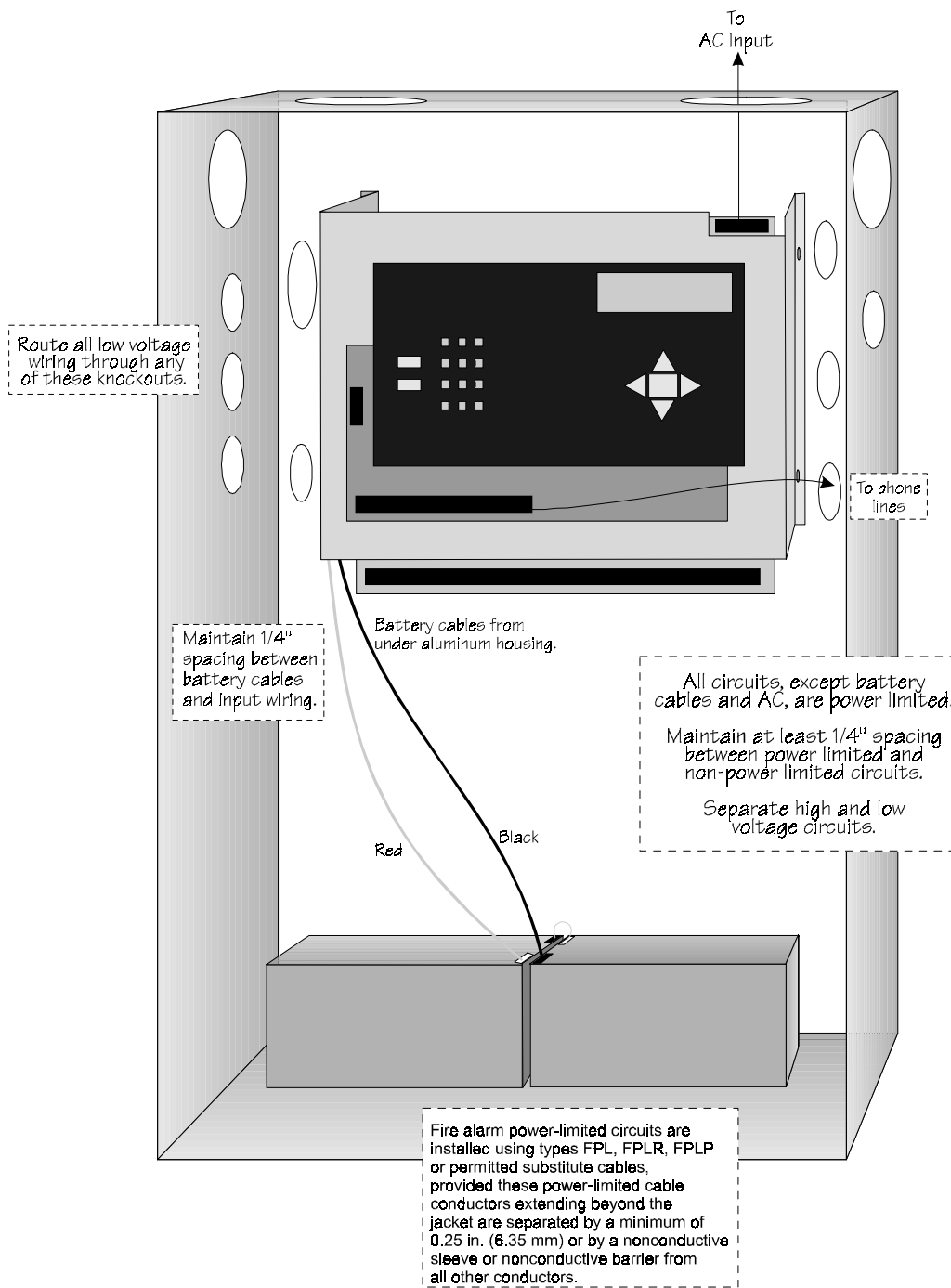


Figure 3-1 Wire Routing Example

3.5 Board Assembly Diagram

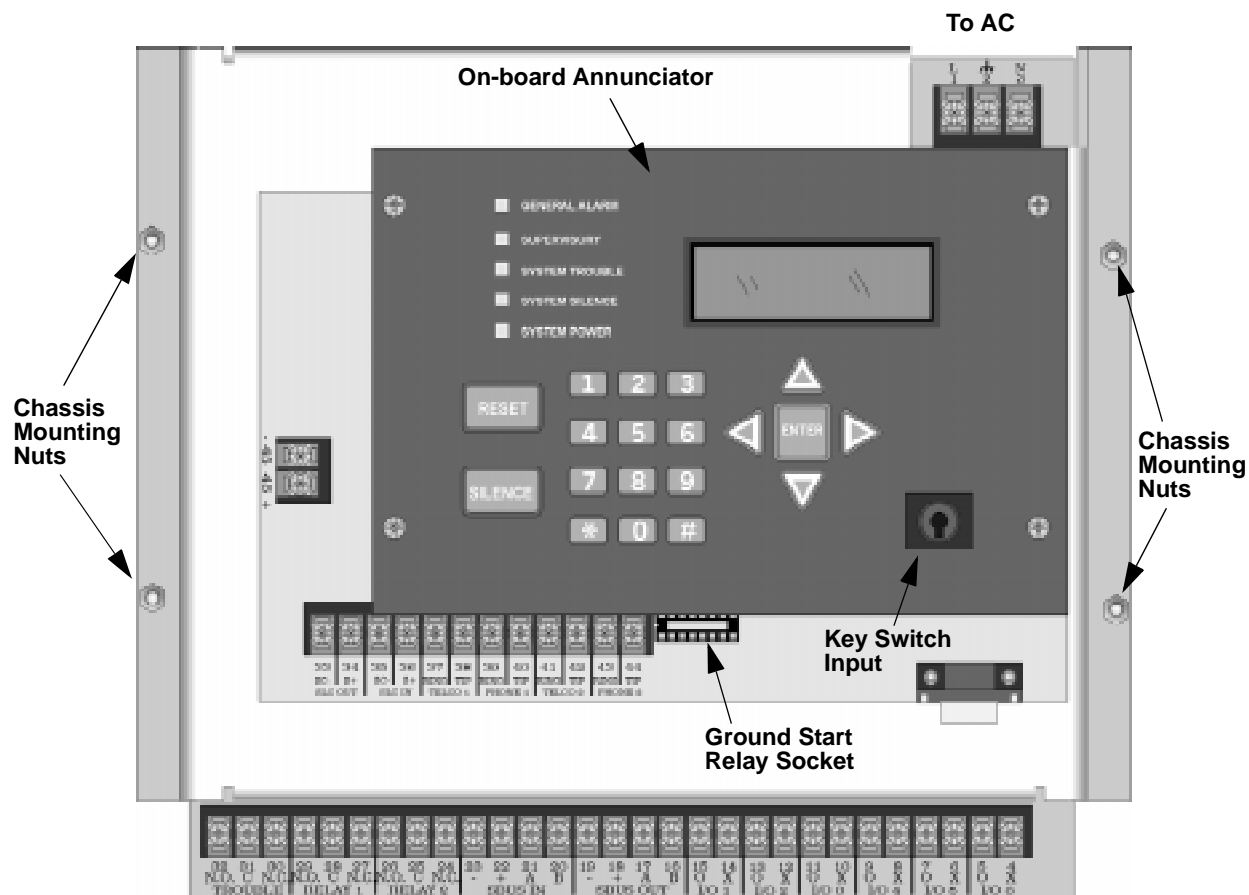


Figure 3-2 Model 5820XL Assembly

Figure 3-2 shows the circuit boards, metal housing and annunciator that attach the 5820XL assembly to the cabinet. If you should need to remove the board assembly for repair, remove the four mounting nuts which hold the assembly in the cabinet. Then lift the entire assembly out of the cabinet. Do not attempt to remove the circuit boards from the metal bracket.

3.6 Calculating Current Draw and Standby Battery

This section is for helping you determine the current draw and standby battery needs for your installation.

3.6.1 Worksheet Requirements

The following steps must be taken when determining 5820XL current draw and standby battery requirements.

Filling in the Current Draw Worksheet, Table 3-2 (Section 3.6.2)

1. For the 5820XL, the worst case current draw is listed for the panel, addressable devices, and all SBUS expanders. Fill in the number of addressable devices and expanders that will be used in the system and compute the current draw requirements for alarm and standby. Record this information in Table 3-2 at Line A.
2. Add up the current draw for all auxiliary devices and record in the table at Line B.
3. Add up all notification appliance loads and record in the table at Line C.
4. For notification appliances and auxiliary devices not mentioned in the manual, refer to the device manual for the current ratings.
5. Make sure that the total alarm current you calculated, including current for the panel itself, does not exceed 5.0 A. This is the maximum alarm current for the 5820XL control panel.

If the current is above 5.0 A you will need to use a notification power expander(s) such as the Silent Knight 5395 or the 5895XL intelligent power expander, to distribute the power loads so that the 5820XL or the power expanders do not exceed their power rating. Refer to the current draw worksheets provided with the 5395 or 5895XL manuals so you do not exceed their power requirements.

6. Complete the remaining instructions in Table 3-2 for determining battery size requirements.

3.6.2 Current Draw Worksheet

Use the worksheet beginning on the next page to determine current requirements during alarm/battery standby operation. (Copy the page if additional space is required.)

Table 3-2: Current Draw Calculations

Device	# of Devices	Current per Device	Standby Current	Alarm Current	
For each device use this formula: This column X This column = Current per number of devices.					
IntelliKnight 5820XL Fire Panel (Current draw from battery)	1	Standby: 140 mA	140 mA		
		Alarm: 260 mA		260 mA	
Addressable SLC Devices	(381 max.)	Standby: 0.55 mA	mA		
		Alarm: 0.55 mA		mA	
5815XL SLC Expander	(2 max.)	Standby: 55 mA	mA		
		Alarm: 55 mA		mA	
5860 Remote Fire Alarm Annunciator	(8 max.)	Standby: 20 mA	mA		
		Alarm: 25 mA		mA	
5824 Serial / Parallel Module	(2 max.)	Standby: 45 mA	mA		
		Alarm: 45 mA		mA	
5895XL IntelliKnight Power Expander	(8 max.)	Standby: 10 mA	mA		
		Alarm: 10 mA		mA	
5865-4 LED Annunciator (with reset and silence switches)	(8 max.)	Standby: 35 mA	mA		
		Alarm: 145 mA		mA	
Standby: 35 mA		mA			
Alarm: 145 mA			mA		
Standby: 35 mA		mA			
Alarm: 200 mA			mA		
5880 Generic LED Driver Module					
Total System Current					
*Auxiliary Devices	Refer to devices manual for current rating.				
		Alarm/Standby: mA	mA	mA	
		Alarm/Standby: mA	mA	mA	
		Alarm/Standby: mA	mA	mA	
		Alarm/Standby: mA	mA	mA	
Auxiliary Devices Current					
		Alarm: mA		mA	
		Alarm: mA		mA	
		Alarm: mA		mA	
		Alarm: mA		mA	
Notification Appliances Current					
Total current ratings of all devices in system (line A + line B + C)			mA	mA	
Total current ratings converted to amperes (line D x .001):			A	A	
Number of standby hours (24 or 60 for NFPA 72, chapter 1, 1-5.2.5):			H		
Multiply lines E and F. Total standby AH			AH		
Alarm sounding period in hours. (For example, 5 minutes = .0833 hours)				H	
Multiply lines E and H. Total alarm AH				AH	
**Add lines G and I. Total ampere hours required			AH		

* If you are using door holders, you do not need to consider door holder current for alarm/battery standby, because power is removed during that time. However, during normal operation, door holders draw current and must be included in the 5.0 A total current that can be drawn from the panel.

** Use next size battery with capacity greater than required.

3.6.2.1 Maximum Battery Standby Load

Table 3-3 shows the maximum battery standby load for the 5820XL based on 24 and 60 hours of standby. The standby load calculations of line D in the Current Draw Calculation Worksheet (Table 3-2) must be less than the number shown in Table 3-3 for the battery size used and standby hours required.

Table 3-3: Maximum Battery Standby Load

Rechargeable Battery Size	Max. Load for 24 hrs. Standby, 5 mins. Alarm	*Max. Load for 60 hrs. Standby, 5 mins. Alarm
7 AH	270 mA	105 mA
12 AH	475 mA	190 mA
17 AH	685 mA	270 mA
33 AH	1.3 A	540 mA

* Required for NFPA 72 Auxiliary Protected Fire Alarm systems for Fire Alarm Service (City Box) and Remote Station Protected Fire Alarm systems (Polarity Reversal) and Digital Alarm Communicator/Transmitter (DACT).

Warning!

Silent Knight does not support the use of batteries smaller than those listed in Table 3-3. If you use a battery too small for the installation, the system could overload the battery resulting in the installation having less than the required 24 hours standby power. Use Table 3-2 to calculate the correct battery amperes/hour rating needed for your installation.

3.7 Installation Tasks Overview

This section of the manual is a chart listing tasks that need to be performed when installing the IntelliKnight 5820XL system. The chart is intended to be a handy way for you to make sure you have completed all necessary tasks. Unless noted, these tasks do not have to be performed in the order they are listed here.

Important: Connect and address SLC devices before running JumpStart.

Task	See Sec. (for more info.)
Main Panel Hardware Installation	
<input type="checkbox"/> Mount the control panel cabinet.	4.1
<input type="checkbox"/> Connect AC.	4.2
<input type="checkbox"/> Connect phone lines.	4.11
<input type="checkbox"/> Install 5815XL SLC Expander modules (if needed). Required if more than 127 SLC devices are used.	4.6
<input type="checkbox"/> Install 5860 Remote Fire Alarm Annunciator modules if used.	4.5
<input type="checkbox"/> Install 5865 or LED Annunciator modules if used.	4.9
<input type="checkbox"/> Install 5880 LED Driver Module if customized LED annunciation will be used.	4.8
<input type="checkbox"/> Install notification appliances.	4.12
<input type="checkbox"/> Install auxiliary power devices (if used).	4.12.5
<input type="checkbox"/> If using a printer, install Model 5824 Serial/Parallel Interface.	4.7
<input type="checkbox"/> Connect batteries (typically last step).	4.3
SLC Device Hardware Installation Perform these steps before running JumpStart.	
<input type="checkbox"/> Connect device bases to the loop.	5.3
<input type="checkbox"/> Set device addresses.	5.10
<input type="checkbox"/> Physically connect detectors to their bases. Connect relay and contact monitor modules.	5.8.2
JumpStart	
JumpStart is for initial system programming. JumpStart automatically selects some options for SLC devices. See “Input Point Configuration” section of this chart for other options. JumpStart makes selections for the following options. You can customize options, if necessary.	See Section 6.1 and 7.6
Device type (detector or switch) configured by JumpStart.	To change, see Sec. 7.4
Program type of detector (heat, photoelectric, or ionization) selected by JumpStart.	To change, see Sec. 7.4
System Software Configuration	
<input type="checkbox"/> Select low AC hours report time (6 hours by default).	7.5.6.2
<input type="checkbox"/> Select Auto Test Time (2:00 AM by default).	7.5.1.2
<input type="checkbox"/> Enable/disable automatic DST adjustment feature (enabled by default).	7.5.6.3

Task	See Sec. (for more info.)
<input type="checkbox"/> Change clock display format (12-hour with AM/PM by default).	7.5.6.4
<input type="checkbox"/> Enable/disable day/night sensitivity (disabled by default).	7.5.4
<input type="checkbox"/> Select holiday schedule (up to 18 days) if installation is using day/night sensitivity.	7.5.5
<input type="checkbox"/> Set up reporting accounts.	7.5.1
<input type="checkbox"/> Select options for phone lines.	7.5.2
<input type="checkbox"/> Select system-wide response to trouble conditions, if desired.	7.5.3
<input type="checkbox"/> Select system-wide cadence patterns for special conditions (fire drill, Aux1 and Aux2 alarms) if desired.	7.5.3
<input type="checkbox"/> Customize banner message (message that displays on LCD in normal mode) if desired.	7.5.8
Input Point (SLC Device) Configuration	
JumpStart automatically selects some options for SLC devices (see “JumpStart” section of this chart). You can change options selected by JumpStart, if necessary and further customize input point options.	
<input type="checkbox"/> Program type of switch (manual pull, fire drill, and so on), if necessary. (JumpStart assigns all switches as Manual Pull type.)	7.4
<input type="checkbox"/> If the installation includes duct detectors, program detector type. (JumpStart does not distinguish duct detectors from ordinary smoke detectors.)	7.4
<input type="checkbox"/> Assign a name (or description) to the point.	7.4.3.1
<input type="checkbox"/> Assign input points to zones, if necessary. (JumpStart assigns all input points to Zone 1.)	7.4
Zone Configuration	
<input type="checkbox"/> Add the zone to the system if it does not already exist. (Zone 1 created by JumpStart.)	7.2.2
<input type="checkbox"/> Program a name (or description) for the zone.	7.2.1.1
<input type="checkbox"/> Select alarm delay options (detection characteristics) for zone.	7.2.1.2
<input type="checkbox"/> Select heat detector trip temperature and/or smoke sensitivity level for photoelectric smoke detectors. (JumpStart selects 150(F for heat detectors and Low sensitivity for smoke detectors.)	7.2.1.2
Output Point Configuration	
Conventional notification circuits (circuits 1-6):	
<input type="checkbox"/> Enable circuits used for notification appliances through programming, if necessary. (JumpStart enables circuits 1-6 as Notification.)	7.3.1
Conventional relay circuits (circuits 7-8):	
<input type="checkbox"/> Select options for relay circuits, if desired. Note: Relay circuits will always output continuously (constant pattern), even if assigned to an Output Group that uses a different output pattern.	7.3.1
Auxiliary power circuits (circuits 1-6):	
<input type="checkbox"/> Enable any circuit used for auxiliary power devices through programming.	7.4
<input type="checkbox"/> Select type of power (door holder, constant, or resettable)	7.4

Task	See Sec. (for more info.)
Addressable relay modules	
<input type="checkbox"/> Assign addressable relay modules to output groups through programming. (JumpStart assigns all relay modules to Group 1.)	7.4
LED output points (from the 5880 LED Driver or 5865/66 LED Annunciator)	
<input type="checkbox"/> Assign LED modules to output groups through programming.	7.4.3
All output circuits (1-8):	
<input type="checkbox"/> Disable (set to UNUSED) any unused circuits. If you do not disable unused output circuits, they will cause a trouble condition (unless an EOL resistor is used).	7.4
<input type="checkbox"/> Select a name for the point, if desired.	7.4
Output Group Configuration	
<input type="checkbox"/> Add the group to the system if it does not already exist.	7.3.2
<input type="checkbox"/> Assign output points to the group.	7.4
<input type="checkbox"/> Program a name (or description) for the group, if desired.	7.3.1.1
Select “group properties” (see below).	
<input type="checkbox"/> Latching / non-latching	7.3.1
<input type="checkbox"/> Silencing option	7.3.1
<input type="checkbox"/> Select options for activation with system switches.	7.3.1
<input type="checkbox"/> Map zones to output groups that will activate when zone goes into alarm.	7.2.1.3
<input type="checkbox"/> Select a cadence pattern for outputs in the zone.	7.2.1.3

Section 4

Control Panel Installation

Caution!

To avoid the risk of electrical shock and damage to the unit, power should be OFF at the control panel while installing or servicing.

4.1 Mounting the Control Panel Cabinet

Read the environmental specifications in Section 3.2 before mounting the control panel cabinet. This will ensure that you select a suitable location.

The panel should be accessible to main drop wiring runs. It should be mounted as close to the center of the building as possible and located within a secured area, but should be accessible for testing and service.

Mount the control panel cabinet so it is firmly secured to the wall surface. When mounting on concrete, especially when moisture is expected, attach a piece of 3/4-inch plywood to the concrete surface and then attach the cabinet to the plywood. Also mount any other modules to the plywood.

The cabinet can be surface- or flush-mounted. If you will be flush-mounting the cabinet, the hole for the enclosure should be 14.75" W x 25" H x 4" D. Do NOT flush-mount in a wall designated as a fire break.

4.1.1 Removing the 5820XL Assembly from the Housing

If it should ever be necessary to remove the control panel assembly from the cabinet for repair, do so by unscrewing the nuts that connect the control panel assembly to the cabinet. Do not attempt to disassemble the circuit boards. See Section 3.5 for location of the nuts.

4.2 AC Connection

At installation, connect the AC terminals to 120 VAC source as shown in Figure 4-1. It may be necessary for a professional electrician to make this connection.

The AC terminals are rated at 120 VAC, 60 Hz, 2.5A.

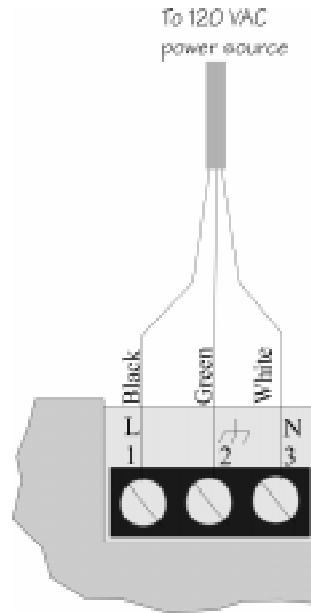


Figure 4-1 AC Power Connection

4.3 Battery Connection

The control panel battery charge capacity is 7.0 to 33.0 AH. Use 12V batteries of the same AH rating. Determine the correct AH rating as per your current load calculation (see Section 3.6).

Wire batteries in series to produce a 24-volt equivalent. Do not parallel batteries to increase the AH rating.

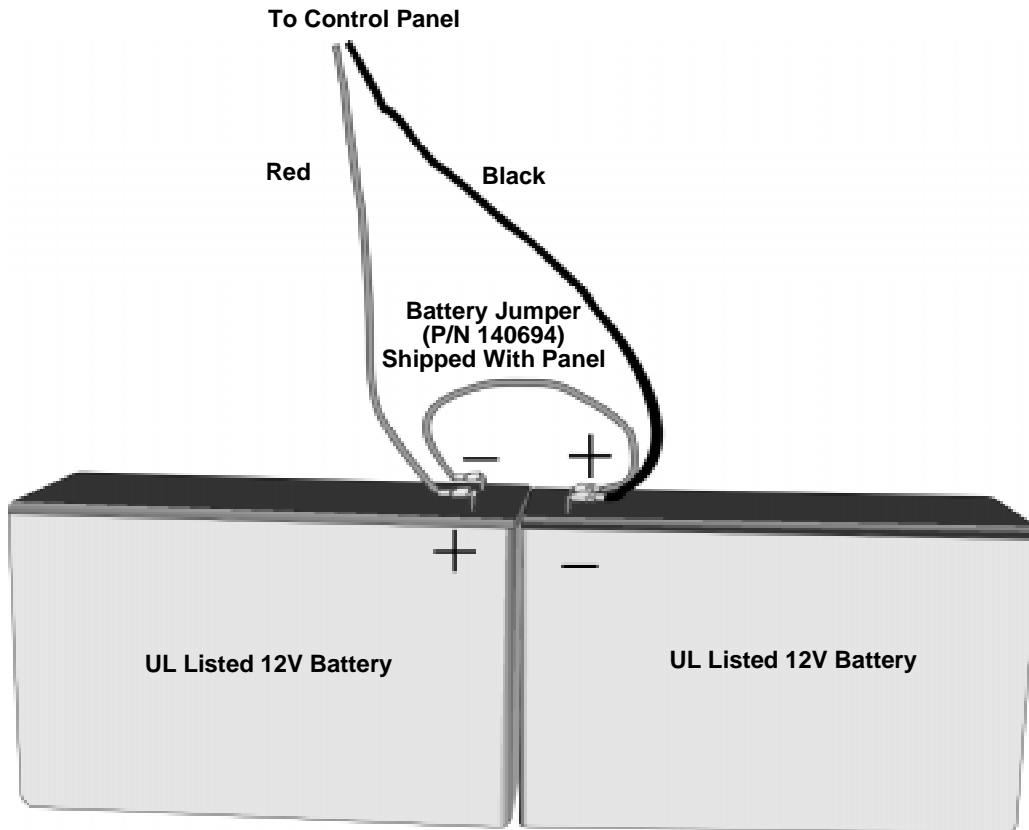


Figure 4-2 Battery Connection

4.3.1 AB-33 Accessory Cabinet

The AB-33 Accessory cabinet can be used when your backup batteries requirements use backup batteries that are too large to fit into the main control panel cabinet. The AB-33 cabinet holds batteries up to the 33 AH size.

4.3.1.1 Installing the AB-33 Accessory Cabinet and Batteries

To properly install the accessory cabinet and backup batteries, follow these steps:

1. Mount the accessory cabinet. See figure Figure 4-3 for the four cabinet mounting holes.
 - If mounting onto drywall the accessory cabinet must be mounted onto 3/4-inch plywood. This is necessary because the weight of the batteries inside the accessory cabinet could cause the cabinet to pull away from the drywall.
 - When mounting on concrete, especially when moisture is expected, attach a piece of 3/4-inch plywood to the concrete surface and then attach the AB-33 cabinet to the plywood.
 - If using the battery cable extenders provided (P/N 140643), mount the AB-33 cabinet no more than 18" away from the main control panel cabinet. This will ensure that the battery cables reach the battery terminals.

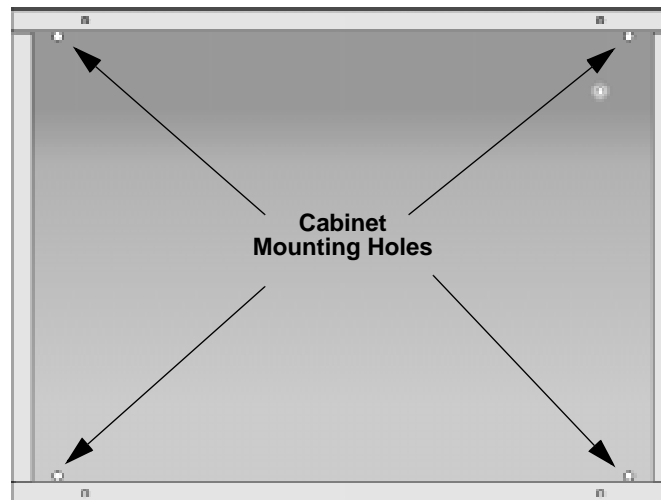


Figure 4-3 AB-33 Cabinet Mounting Holes

2. Connect the main control panel battery cables to the battery cable extenders as shown in Figure 4-4.

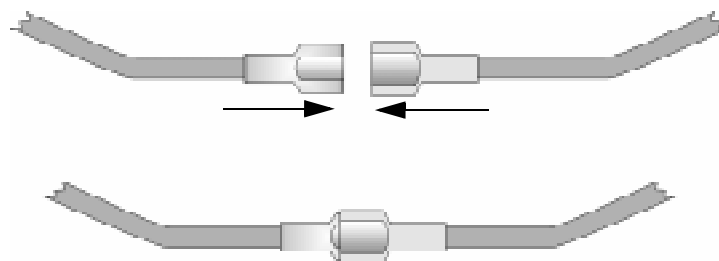


Figure 4-4 Splicing Control panel Battery Cable to AB-33 Battery Cable Extenders

Control Panel Installation

3. Run extended battery cable from control panel cabinet through conduit to AB-33 cabinet. See Figure 4-5.

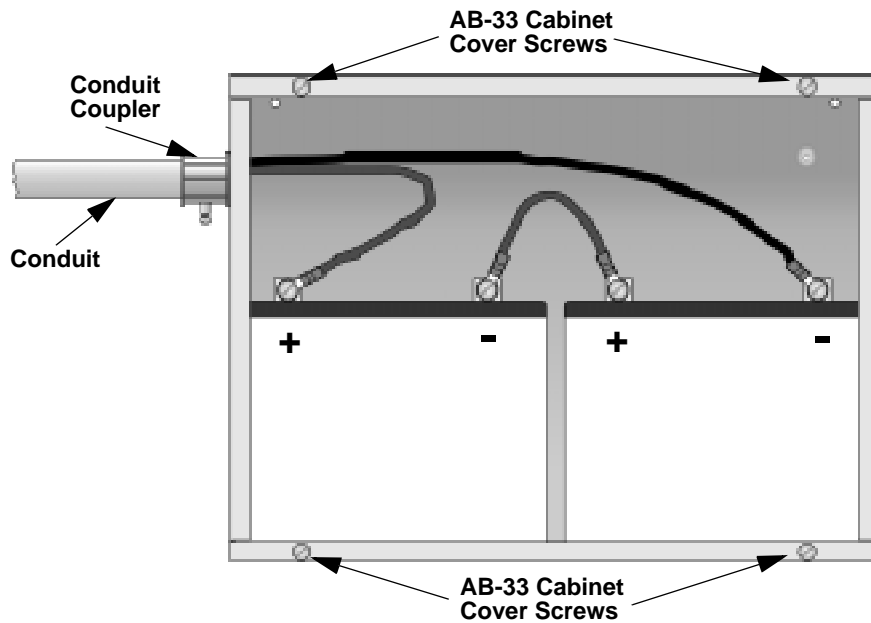


Figure 4-5 Battery Connections in the AB-33 Cabinet

Note: Any one of the cabinet knock-outs (on either the main control panel or the AB-33 cabinet), that are not previously being used may be utilized to connect conduit between the two cabinets.

4. Connect battery leads to the backup battery terminals. See Figure 4-5.
Observe the proper polarity to prevent damage to the batteries or the control panel.
5. Insert the AB-33 cover screws into the cover mounting holes (see Figure 4-5).
Screw the cover screw 3/4 of the way into the cover mounting hole.
6. Align the cover plate mounting keyhole over the cover mounting screws. See Figure 4-6.

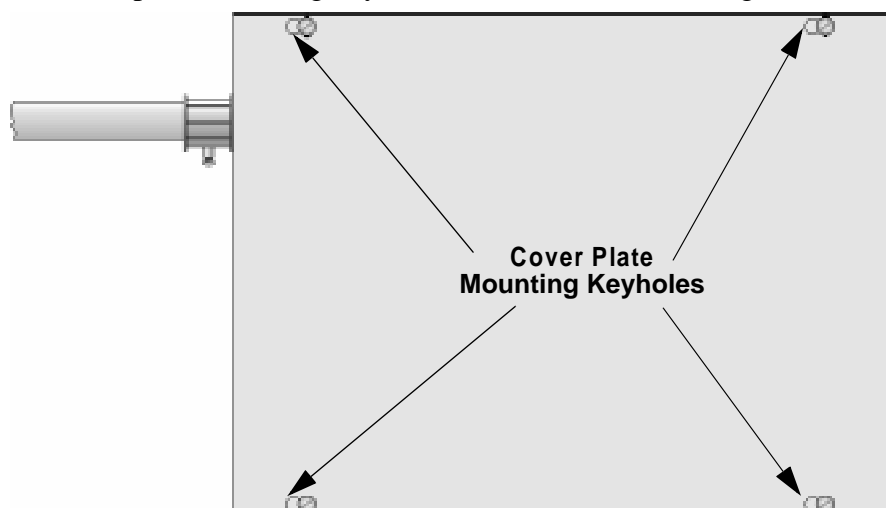


Figure 4-6 Cover Plate Mounting Keyholes and Cover Mounting Screws Alignment

7. Slide the cover into place and tighten the cover mounting screws. See Figure 4-6.

4.4 SBUS Wiring

This section contains information on calculating SBUS wire distances and the types of wiring configurations (Class A and B).

4.4.1 Calculating Wiring distance for SBUS modules

The following instructions will guide you in determining the type of wire and the maximum wiring distance that can be used with control panel SBUS accessory modules.

To calculate the wire gauge that must be used to connect SBUS modules to the control panel, it is necessary to calculate the total worst case current draw for all modules on a single 4-conductor bus. The total worst case current draw is calculated by adding the individual worst case currents for each module. The individual worst case values are shown in the table below.

Note: Total worst case current draw on a single SBUS cannot exceed 1 amp. If a large number of accessory modules are required, and the worst case current draw will exceed the 1 amp limit, then the current draw must be distributed using 5895XL Power Expanders. Each 5895XL Power Expander provides an additional SBUS, with an additional 1 amp of SBUS current. Wiring distance calculations are done separately for each 5895XL, and separately for the control panel itself.

Model Number	Worst Case Current Draw
5860 Fire Annunciator	.100 amps
5824 Parallel/Serial Interface	.040 amps
5880 LED Driver Module	.250 amps
5865 LED Fire Annunciator	.200 amps
5895XL Intelligent Power Supply	.010 amps

After calculating the total worst case current draw, Table 4-1 specifies the maximum distance the modules can be located from the panel on a single wire run. The table insures 6.0 volts of line drop maximum. In general, the wire length is limited by resistance, but for heavier wire gauges, capacitance is the limiting factor.

Control Panel Installation

These cases are marked in the chart with an asterisk (*). Maximum length can never be more than 6,000 feet, regardless of gauge used. (The formula used to generate this chart is shown in the note below).

Table 4-1: Wire Distances Per Wire Gauge

Wiring Distance: SBUS Modules to Panel				
Total Worst Case Current Draw (amps)	22 Gauge	18 Gauge	16 Gauge	14 Gauge
0.100	1852 ft.	4688 ft.	* 6000 ft.	* 6000 ft.
0.200	926 ft.	2344 ft.	3731 ft.	5906 ft.
0.300	617 ft.	1563 ft.	2488 ft.	3937 ft.
0.400	463 ft.	1172 ft.	1866 ft.	2953 ft.
0.500	370 ft.	938 ft.	1493 ft.	2362 ft.
0.600	309 ft.	781 ft.	1244 ft.	1969 ft.
0.700	265 ft.	670 ft.	1066 ft.	1687 ft.
0.800	231 ft.	586 ft.	933 ft.	1476 ft.
0.900	206 ft.	521 ft.	829 ft.	1312 ft.
1.000 (Max)	185 ft.	469 ft.	746 ft.	1181 ft.

Note: The following formulas were used to generate the wire distance chart:

$$\text{Maximum Resistance (Ohms)} = \frac{6.0 \text{ Volts}}{\text{Total Worst Case Current Draw (amps)}}$$

$$\text{Maximum Wire Length (Feet)} = \frac{\text{Maximum Resistance (Ohms)}}{\text{Rpu}} \quad * 500$$

(6000 feet maximum)

where: Rpu = Ohms per 1000 feet for various Wire Gauges (see table below)

Table 4-2: Typical Wire Resistance Per 1000 ft.

Wire Gauge	Ohms per 1000 feet (Rpu)
22	16.2
18	6.4
16	4.02
14	2.54

Wiring Distance calculation example:

Suppose a system is configured with the following SBUS modules:

- 2 - Module 5860 Fire Annunciator
- 1 - 5895XL Intelligent Power Expander
- 1 - 5865 LED Fire Annunciator
- 1 - 5824 Parallel/Serial Interface

The total worst case current is calculated as follows:

5860 Current Draw	= 2 x .100 amps	= .200 amps
5895XL Current Draw	= 1 x .010 amps	= .010 amps
5865 Current Draw	= 1 x .200 amps	= .200 amps
5824 Current Draw	= 1 x .040 amps	= .040 amps
<hr/>		
Total Worst Case Current Draw		= .450 amps

Using this value, and referring to the Wiring Distance table, it can be found that the available options are:

- 370 feet maximum using 22 Gauge wire
- 938 feet maximum using 18 Gauge wire
- 1493 feet maximum using 16 Gauge wire
- 2362 feet maximum using 14 Gauge wire

4.4.2 Wiring Configurations

Figure 4-7 illustrates Class A wiring configuration and Figure 4-8 illustrates Class B configuration.

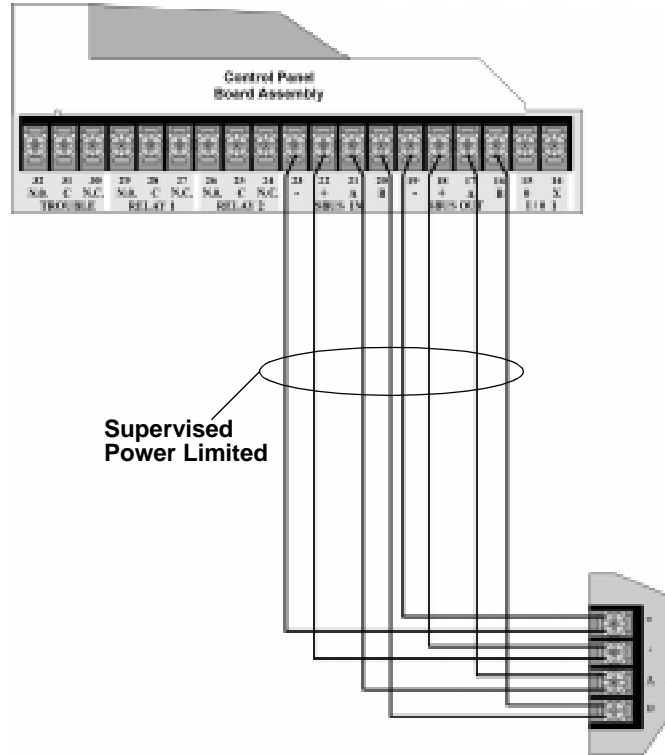


Figure 4-7 SBUS Class A Wiring

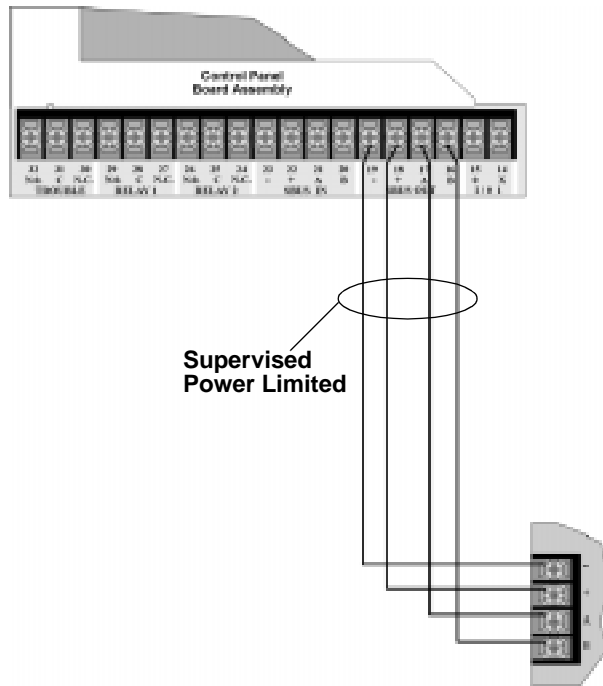


Figure 4-8 SBUS Class B Wiring

4.5 Remote Annunciator 5860 Installation

The optional Model 5860 Remote Annunciator, shown in Figure 4-9, performs the same functions as the on-board annunciator. Operation is identical. Up to 8 annunciators can be added to the IntelliKnight 5820XL system.

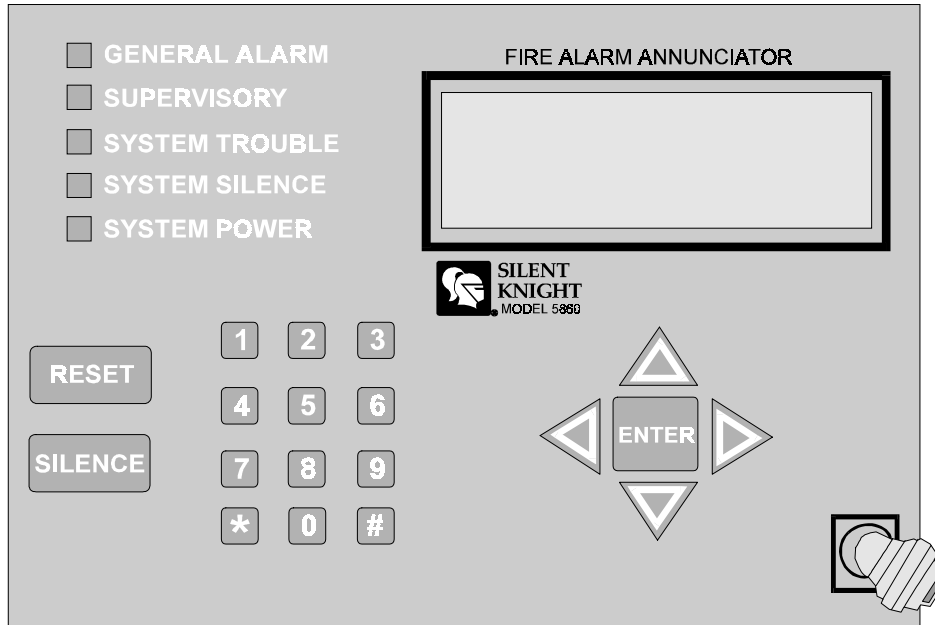


Figure 4-9 Model 5860 Remote Annunciator, Front View

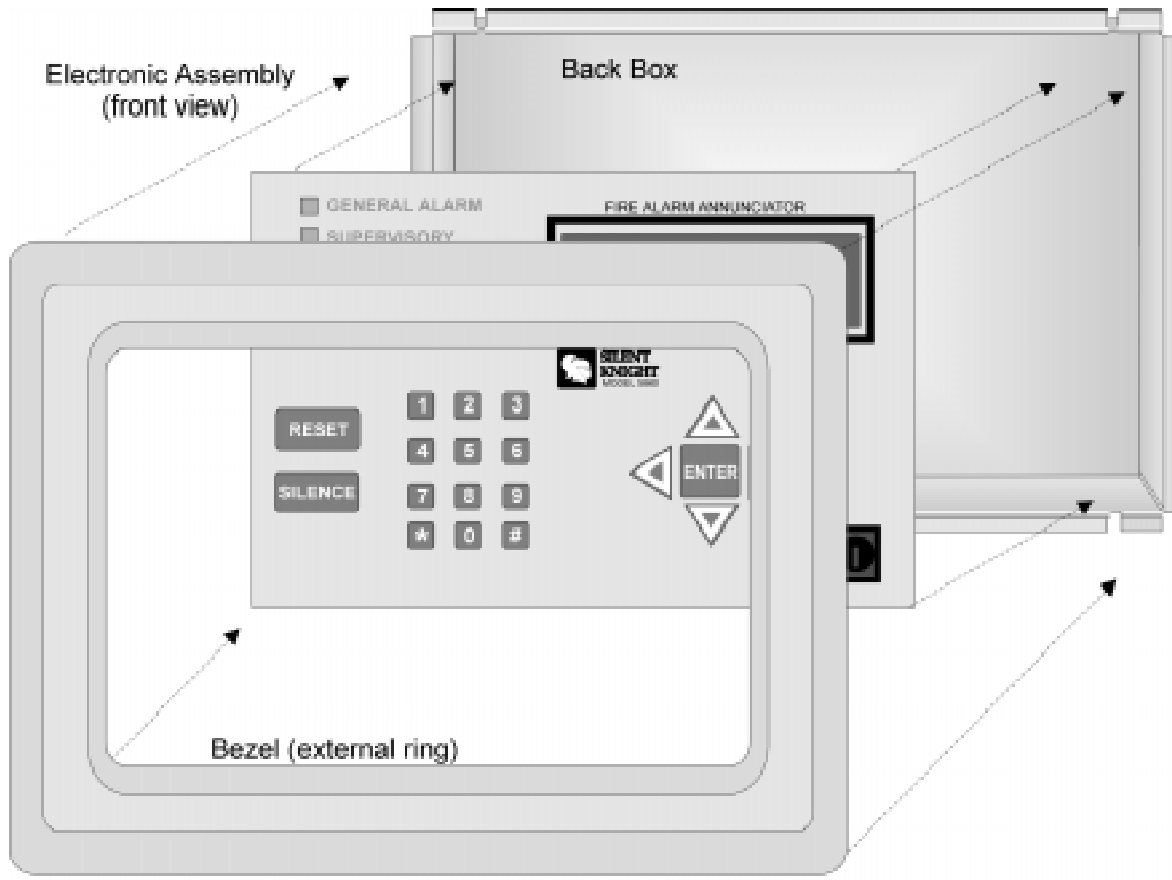
5860 installation involves the following steps:

1. Make sure power is off at the panel.
2. Mount the 5860 in the desired location (see Section 4.5.1).
3. Connect the 5860 to the panel (see Section 4.5.2).
4. Use the dipswitches on the back of the 5860 to assign an ID# to the 5860 (see Section 4.10.1).
5. The new 5860 module must be added to the system through programming. JumpStart will add the module automatically (see Section 6.1). You can also add it manually (see Section 7.1.2). Select a name, if desired (see Section 7.1.1.1).

4.5.1 Mounting the 5860

This section of the manual describes mounting the remote annunciator. The annunciator can be flush- or surface-mounted.

Figure 4-10 shows the parts of the annunciator. Instructions for disassembling and mounting appear on the following pages.



Assembled annunciator also includes mounting wires and 4 set screws.

Figure 4-10 Annunciator Parts

The 5860 comes from the factory fully assembled. You must disassemble it for mounting. To disassemble the annunciator, use a 5/64 hex wrench to remove the set screws, located on the bottom of the annunciator bezel. (See Figure 4-11 for location of the set screws.)

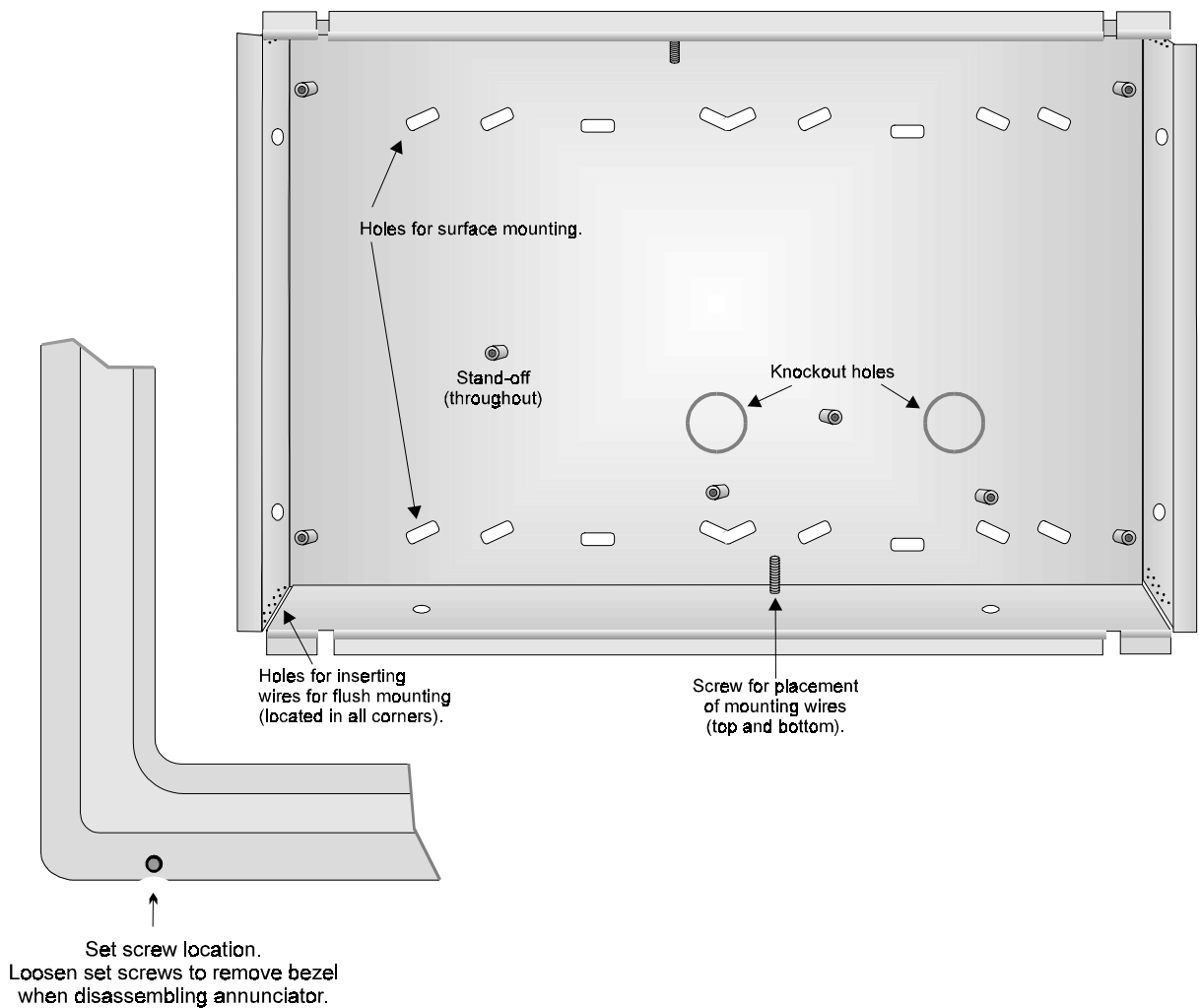


Figure 4-11 Annunciator Back Box and Bezel Details

4.5.1.1 Flush Mounting

This section of the manual describes flush mounting. You can flush-mount with or without an electrical box.

Flush Mounting with an Electrical Box

The 5860 annunciator can be used with the following types of electrical boxes: 4S, single-gang, and double-gang.

If an electrical box is used, the box must be 1-3/8" back from the face of the wall to accommodate the annunciator. Studs used with an electrical box must be two by fours (or larger).

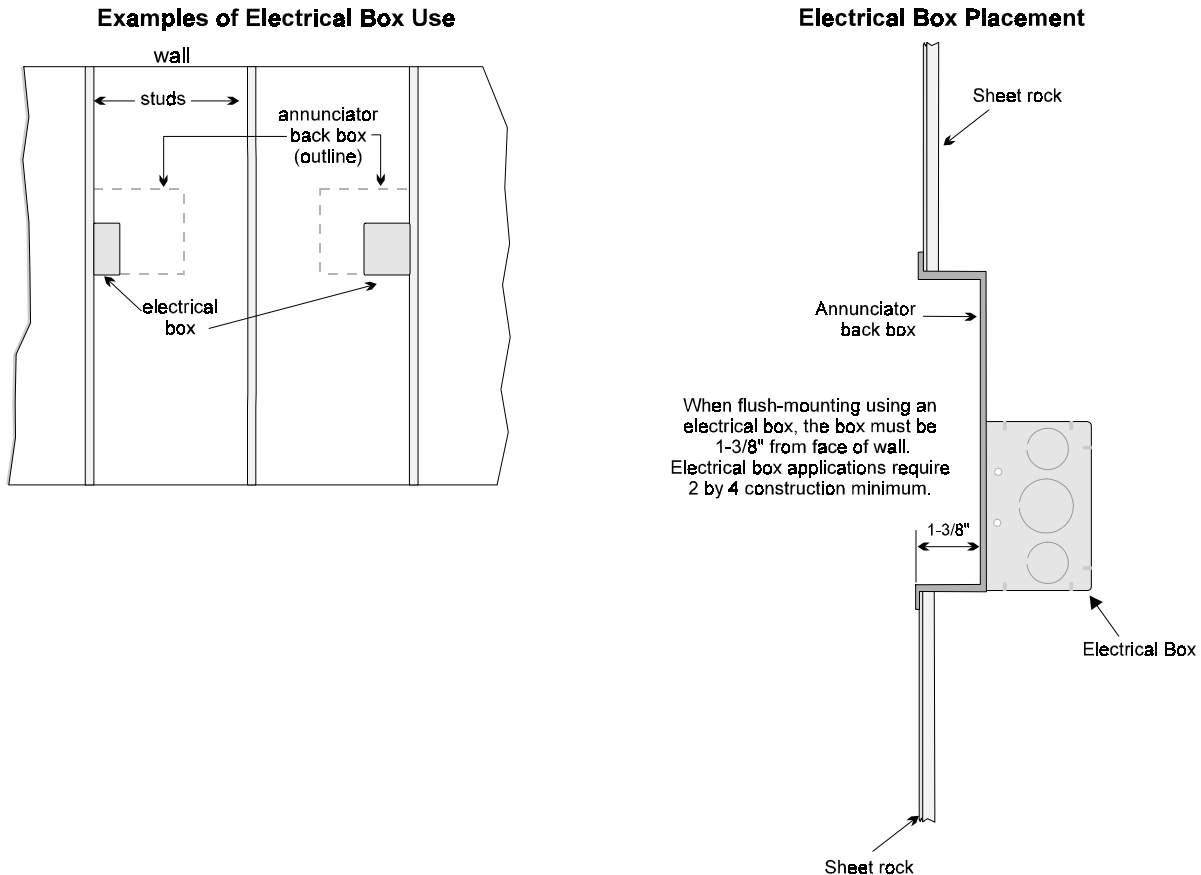


Figure 4-12 Placement of Electrical Box for Flush Mounting

Flush Mounting Steps

1. Cut a hole in the sheet rock to the following dimensions: 8-1/4" w x 6-5/8" h. If an electrical box is used, the box must be 1-3/8" back from face of wall to accommodate the annunciator (see Figure 4-12).
2. Remove knockout holes as needed for wires.
3. Fit the annunciator back box into the hole and stabilize with mounting wires. Angle the mounting wires into the first hole past the sheet rock. Secure the wires behind the screws as shown in Figure 4-13. When all four wires are in place, the back box should fit snugly into the hole in the sheet rock.

4. After the annunciator wiring to the panel has been completed (described in Section 4.5.2), replace the electronic assembly in the back box. Place the bezel over the back box and tighten the set screws on the bezel.

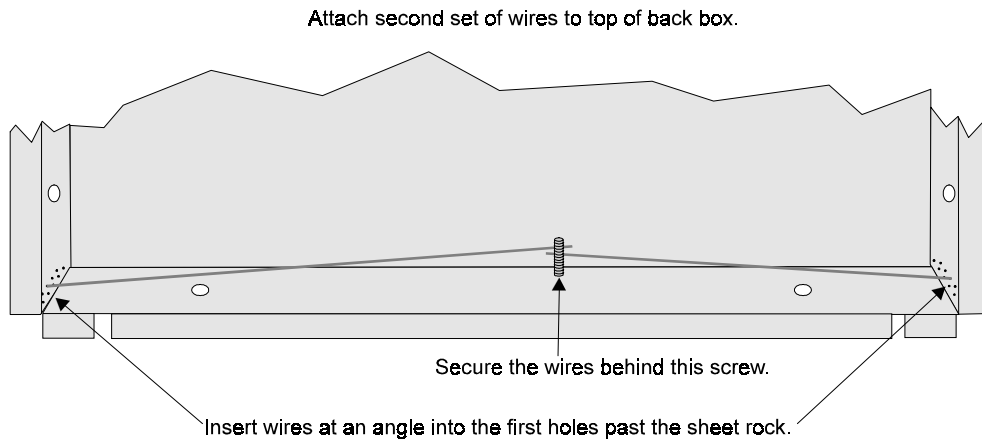


Figure 4-13 Flush Mounting the Back Box

4.5.1.2 Surface Mounting

The 5860 can be mounted directly to a surface or can be attached to a single, double, or four-square electrical box. The Model 5860TG/TR trim ring kit is available for use when surface mounting.

1. Drill holes in the surface to match the screw holes on the back box.
2. Fit the trim ring over the back box.
3. Attach the back box to the surface using screws provided.
4. After the annunciator wiring to the panel has been completed (described in Section 4.5.2), replace the electronic assembly in the back box. Place the bezel over the back box and tighten the set screws on the bezel.

4.5.2 Model 5860 Connection to the Panel

Connect the 5860 to the panel as shown in Figure 4-14.

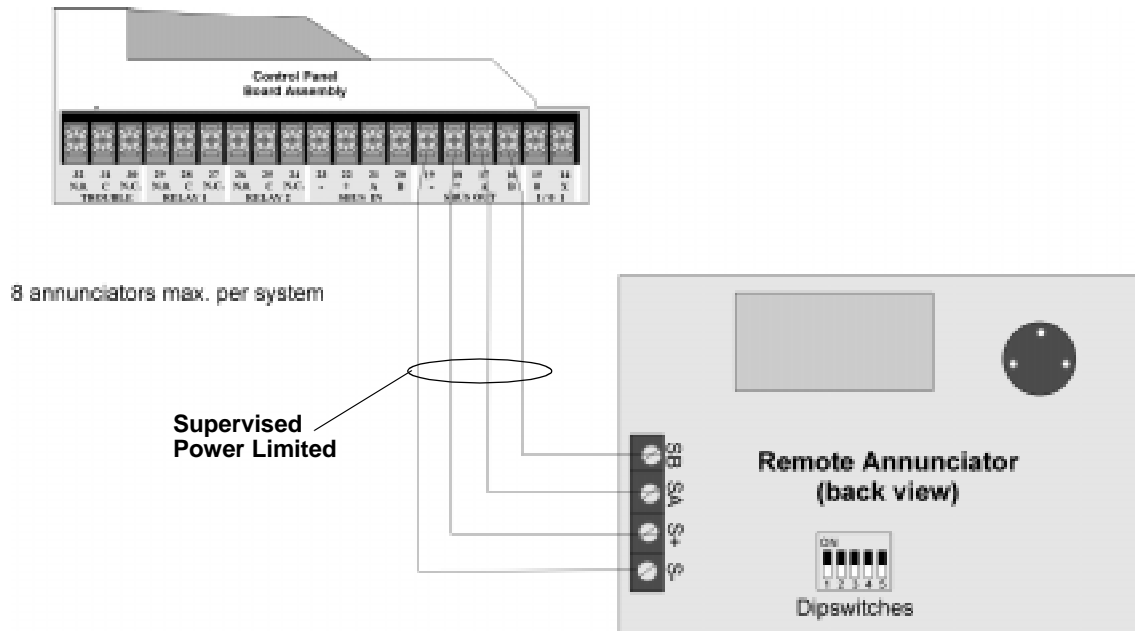


Figure 4-14 Model 5860 Connection to the Panel

4.6 5815XL Installation

The Model 5815XL SLC Expander allows you to add 127 analog addressable devices. Up to two 5815XLs (adding 254 SLC devices) can be used with the system.

5815XL installation involves the following steps.

1. Make sure power is off at the panel.
2. Mount the 5815XL in the 5820XL or 5895XL cabinet. Use the standoffs located under the control panel board assembly and secure with screws provided with the 5815XL. See also *Model 5895XL Installation Instructions P/N 151142*.
3. Connect the 5815XL to the control panel. (See Section 4.6.1.)
4. Use on-board dipswitches to select an ID#. (See Section 4.10.1.)
5. The new 5815XL module must be added to the system through programming. JumpStart will add the module automatically (see Section 6.1). You can also add it manually (see Section 4.10). Select a name, if desired (see Section).
6. You are now ready to connect SLC devices to the 5815XL (see Section 5.3).

Figure 4-15 is a drawing of the 5815XL board, showing the location of terminals and dipswitches.

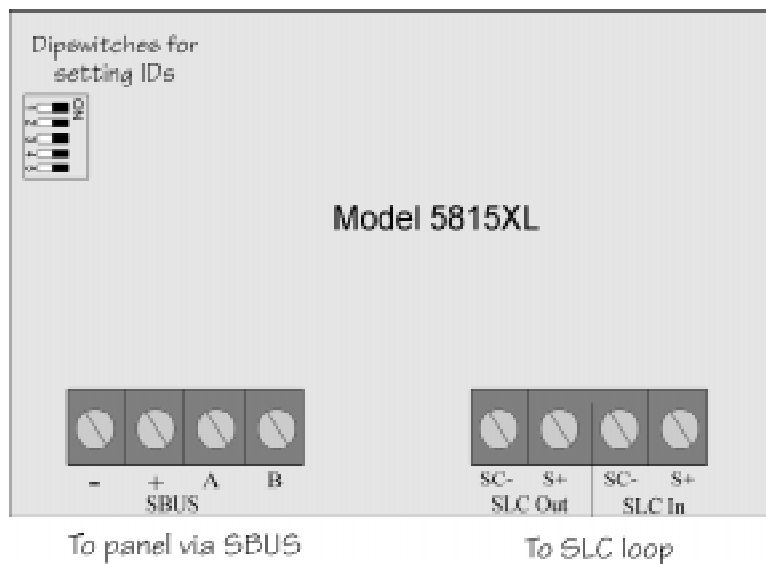


Figure 4-15 5815XL Board

4.6.1 5815XL Connection to the Panel

Connect the 5815XL to the control panel as shown in Figure 4-16. After the 5815XL is connected to the panel, it must be added to the system. This programming step is described in Section 4.10.

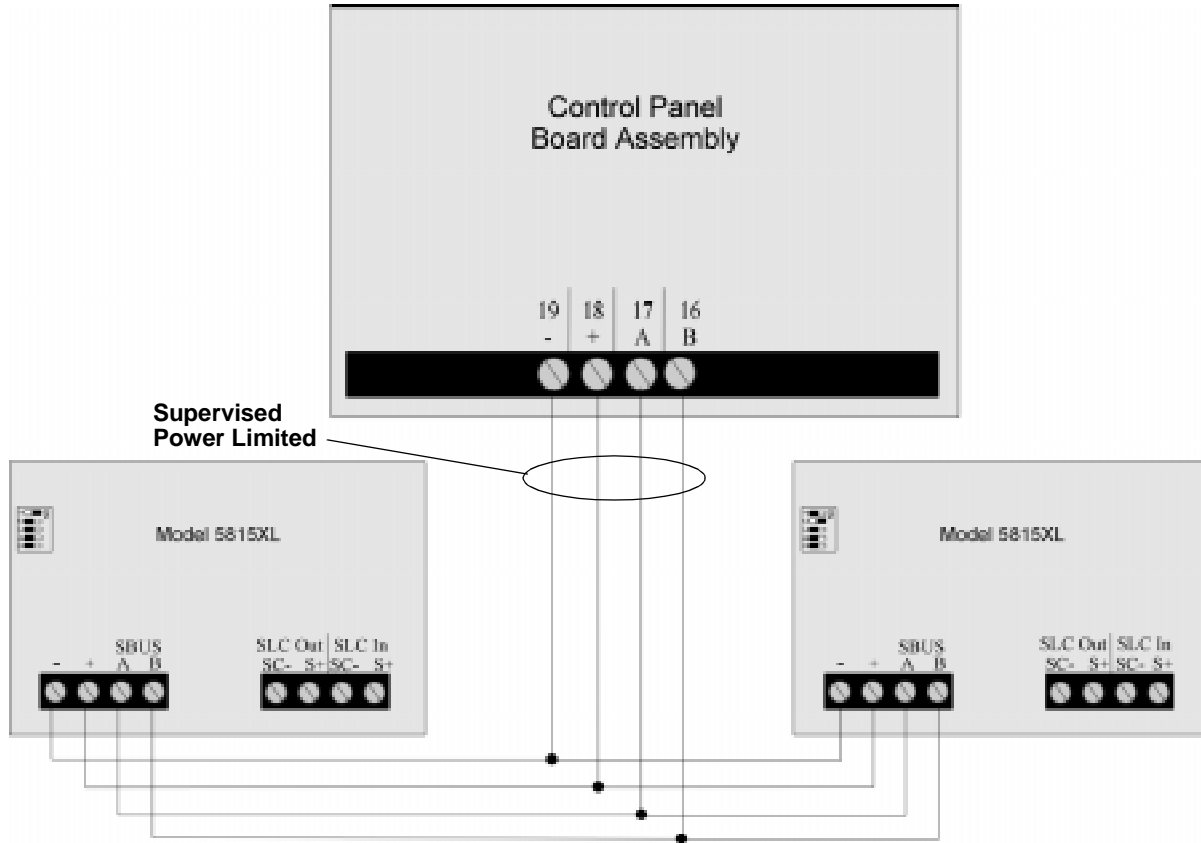


Figure 4-16 5815XL Connection to Main Panel Assembly

4.7 5824 Serial/Parallel Interface Installation

The 5824 Serial / Parallel Interface allows you to connect a printer to the panel, so you can print a real-time log of system events, a report of detector status, and event history. Instructions for installing the 5824 appear below.

5824 installation involves the following steps:

1. Make sure power is off at the panel.
2. Connect the 5824 to the panel as shown in Figure 4-17.

Note: Two 5824s per panel maximum.

3. Use the dipswitches on the back of the 5824 board to assign an ID# to the 5824 (see Section 4.10.1).
4. Configure the 5824 device through programming. See Section 4.7.1.
5. Connect a printer to the 5824 as shown in Figure 4-18.

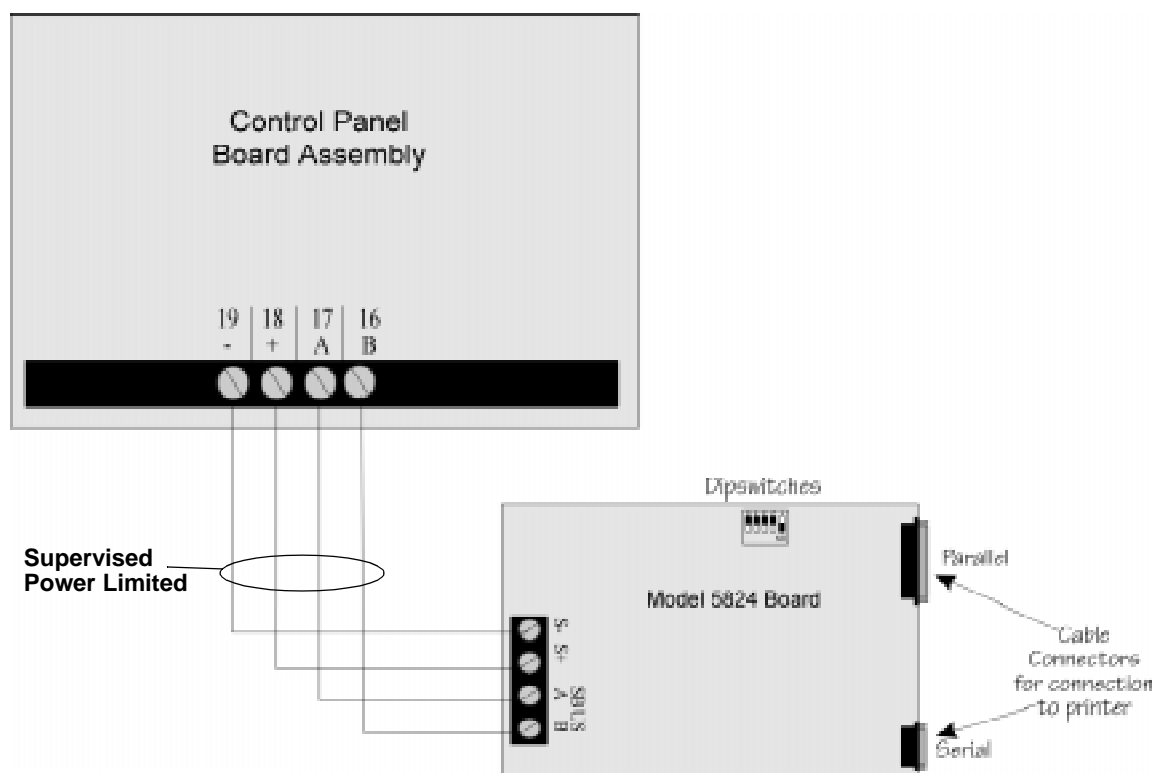


Figure 4-17 5824 Connection to the Panel

Model 5824 (with housing)

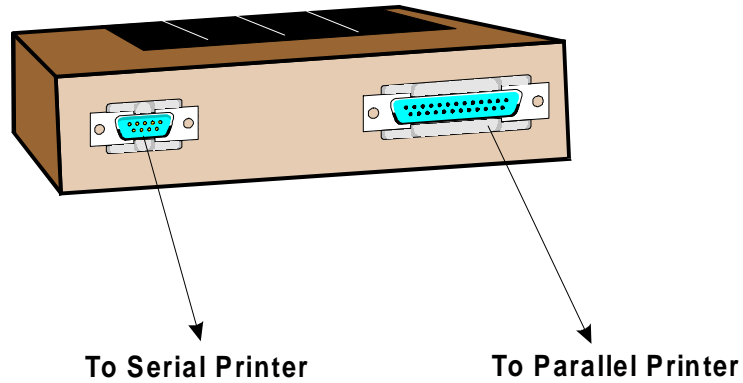


Figure 4-18 Printer Connection

4.7.1 Selecting 5824 Options

Configuring the 5824 includes the following steps:

- Add the module to the system. JumpStart will add the module automatically (see Section 6.1). You can also add it manually (see Section 4.10).
- Select a name, if desired (see Section).
- Select options for the printer and the output port. See below.

Printer and Output Port Options

1. From the Installer Main Menu, select **7** for Program Menu.
2. Select **1** for Module.
3. Select **2** for Edit Module.
4. From the list that displays, select the 5824 module you want to configure.
5. Press **ENTER** **ENTER** to bypass the next two screens. A screen similar to the one shown in Figure 4-19 will display.

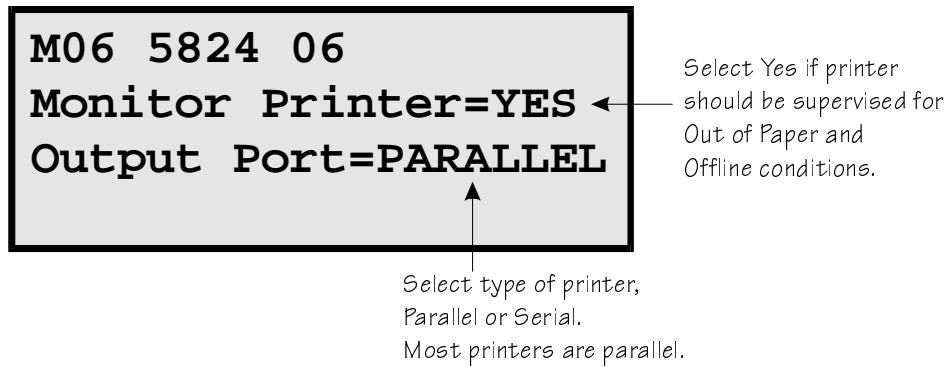


Figure 4-19 Selecting Printer and Output Port Options

6. Select options for the printer as needed for your installation. Most printers are parallel.
7. If you are using a serial printer, use the next screen to select serial port options as required for your printer. Refer to your printer manual if you need more information.

Option	Choices
Baud Rate:	75 - 19200
Data Bits:	5 - 8
Stop Bits:	.5, 1, 2
Parity:	None, Even, Odd

4.8 5880 LED Driver Module

The 5880 is an LED driver board that can be used in a wide variety of applications, including as an interface with most customized floor plan annunciator boards. The 5880 can drive up to 40 LEDs and has one PZT controller. The 5880 also has eight inputs for dry contact monitoring. The following sub-sections describe hardware installation. Refer to Section 6 for programming information.

4.8.1 5880 Board Layout

Figure 4-20 is a picture of the 5880 board showing locations of screw terminals for connection to the panel and contact monitor wiring; pin connectors for connecting LEDs; and the dipswitch for selecting an SBUS ID number.

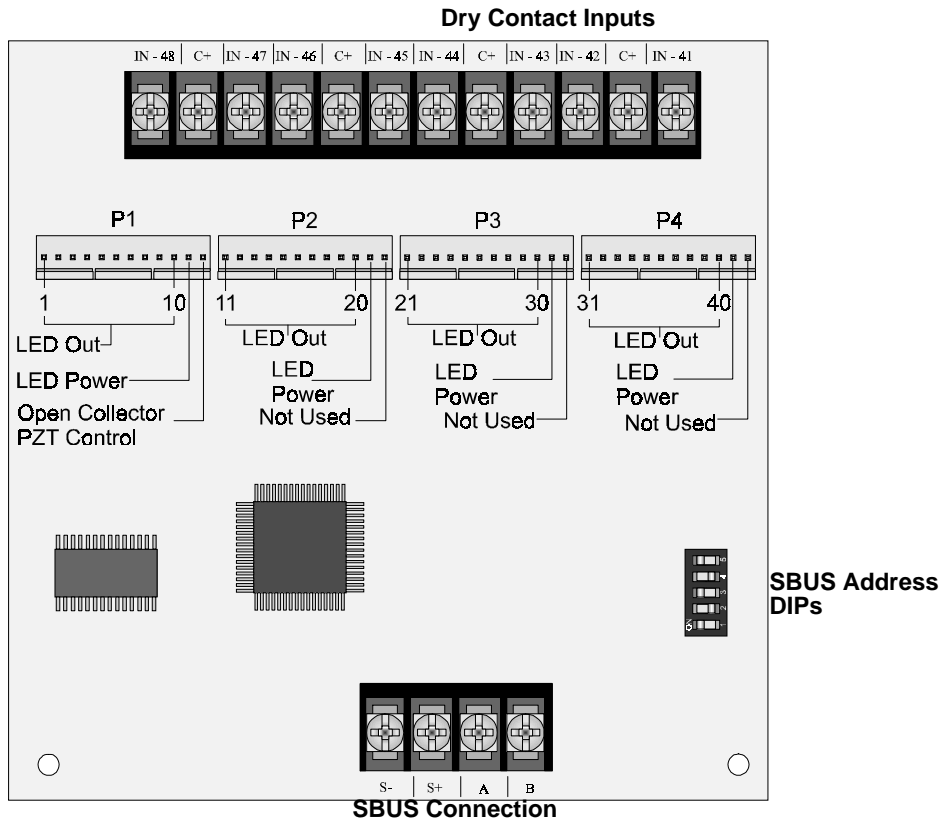


Figure 4-20 5880 Board Layout

4.8.2 FACP Connection

The 5880 connects to the panel via the SBUS. Make connections as shown in Figure 4-21. After the 5880 is connected to the panel, it must be added to the system. This programming step is described in Section 4.10.

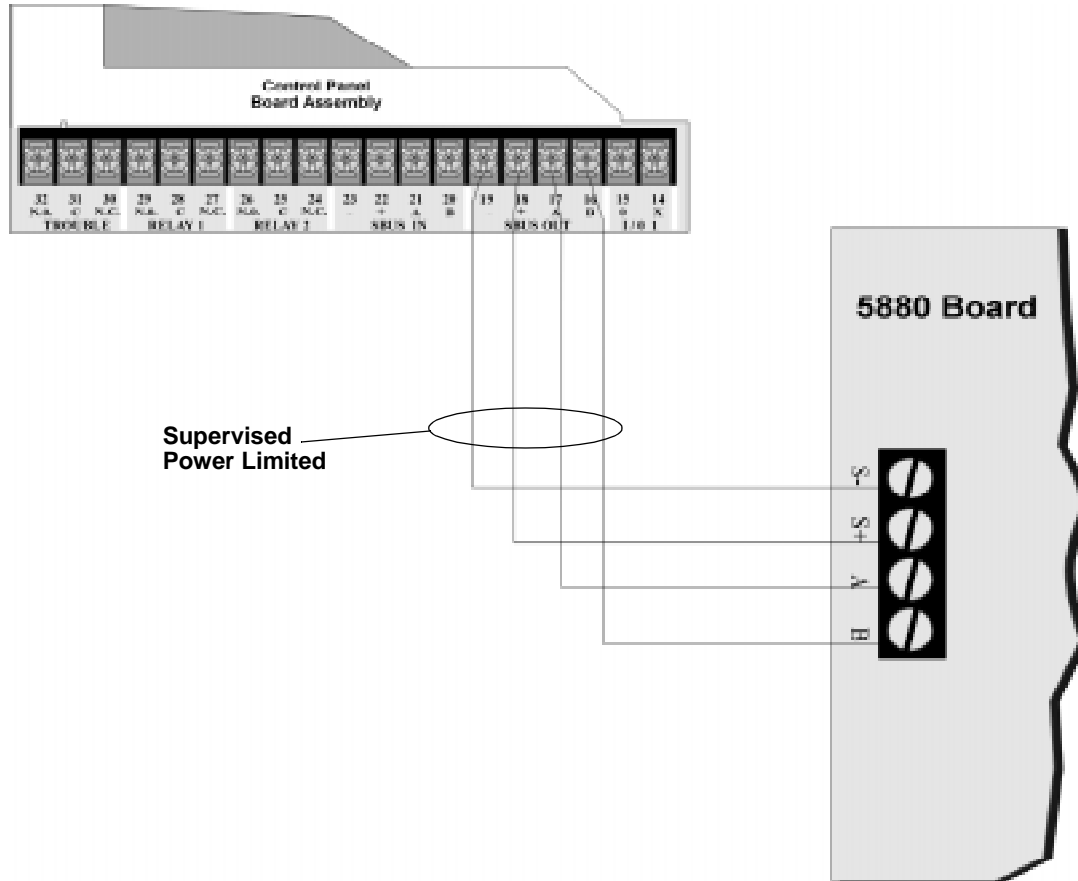


Figure 4-21 5880 Connection to Main Control Panel Assembly

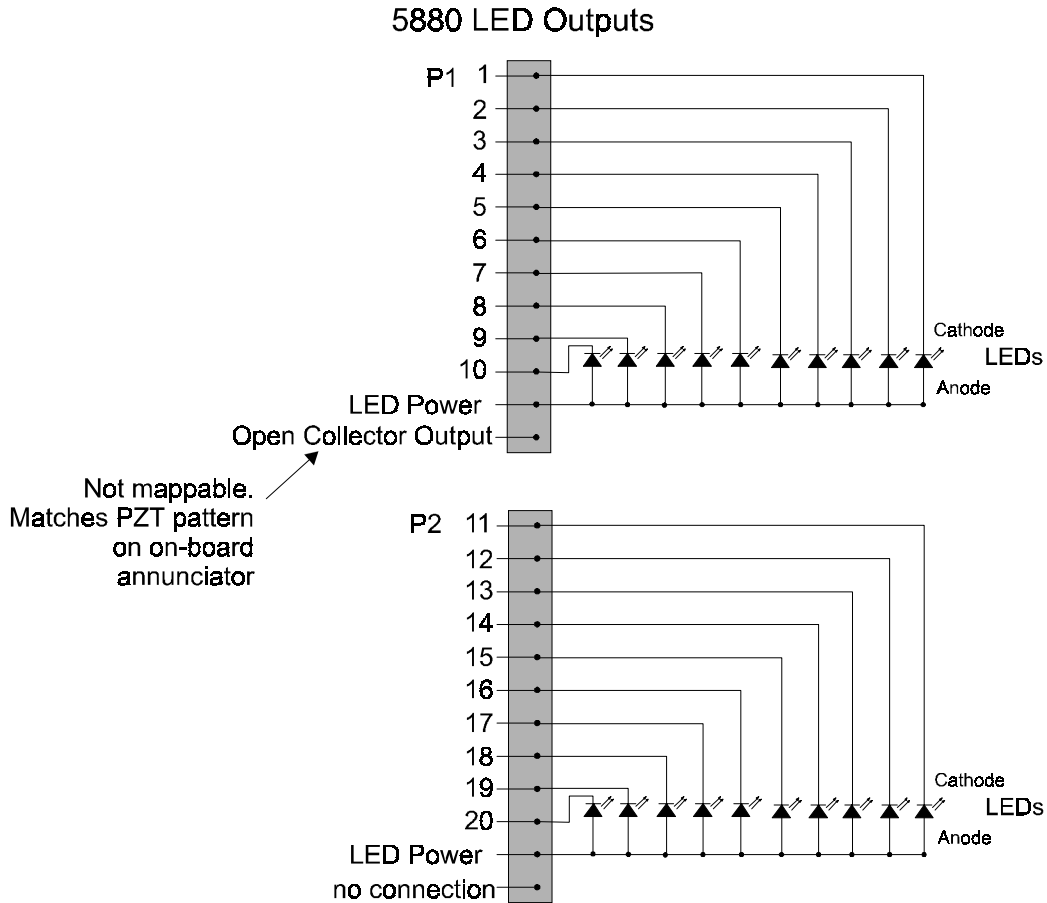
4.8.3 LED Wiring

There are four 12-pin connectors on the 5880 board for connecting LEDs. Each LED gets its power from Pin 11. Internal resistors are sized so that there is approximately 10 mA of current for each LED, no series resistors are required. LED outputs can be mapped to output circuits. See Section 6 for programming details.

Wire the LEDs as shown in Figure 4-22.

On connector P1, Pin 12 is an open collector output for controlling a PZT. If used, the 5880 PZT will match the PZT pattern of the on-board (or 5860) annunciator.

Note: The circuit connected to “Open Collector Output” (last pin on P1) must be current limited so that no more than 100 mA of current is allowed to flow into the open collector transistor.



Connectors P3 and P4 wired same as P2.

Figure 4-22 5880 Board Layout

4.8.4 Dry Contact Wiring

The 8 input circuits on the 5880 board are for monitoring switch inputs-any type of switch supported by the control panel can be used with the 5880. For example, you can use a 5880 to monitor pull stations, water flow, tamper, reset, or silence switches.

Wire dry contacts as shown in Figure 4-23. Notice grouping of terminals; power terminals are shared by two inputs.

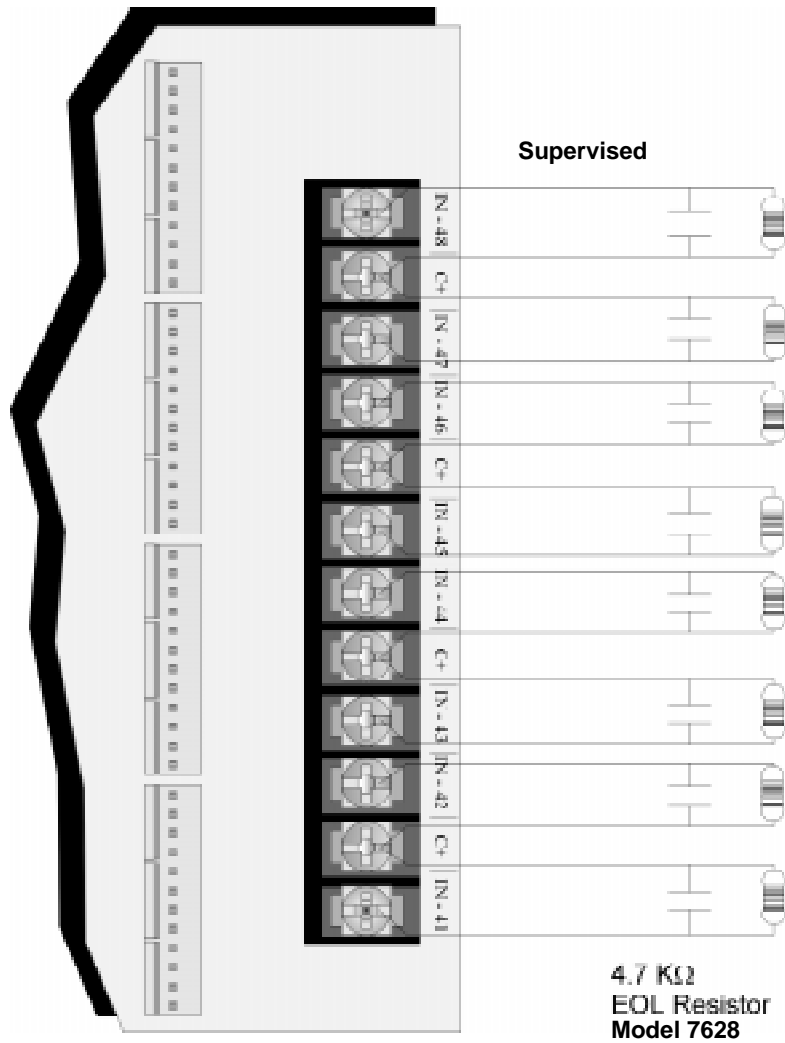


Figure 4-23 Dry Contact Wiring

4.9 5865-3 / 5865-4 LED Annunciator Installation

The 5865-3 and 5865-4 are LED annunciators. The 5865-4 has 30 mappable LEDs, remote silence and reset key switches, and a general system trouble LED. The 5865-3 has 30 mappable LEDs only. These are arranged as 15 pairs of red (typically used for alarm) and yellow (typically used for trouble) LEDs.

Installation of the 5865-5 and 5865-4 is identical. The key switches and the trouble LED follow the behavior of other system annunciators and do not require any installation steps. The following sub-sections describe how to install the 5865-3 and 5865-4 hardware. Refer to Section 6 for programming information.

Note: This manual uses "5865" when referring to aspects of the 5865-3 and 5865-4 that are common to both models.

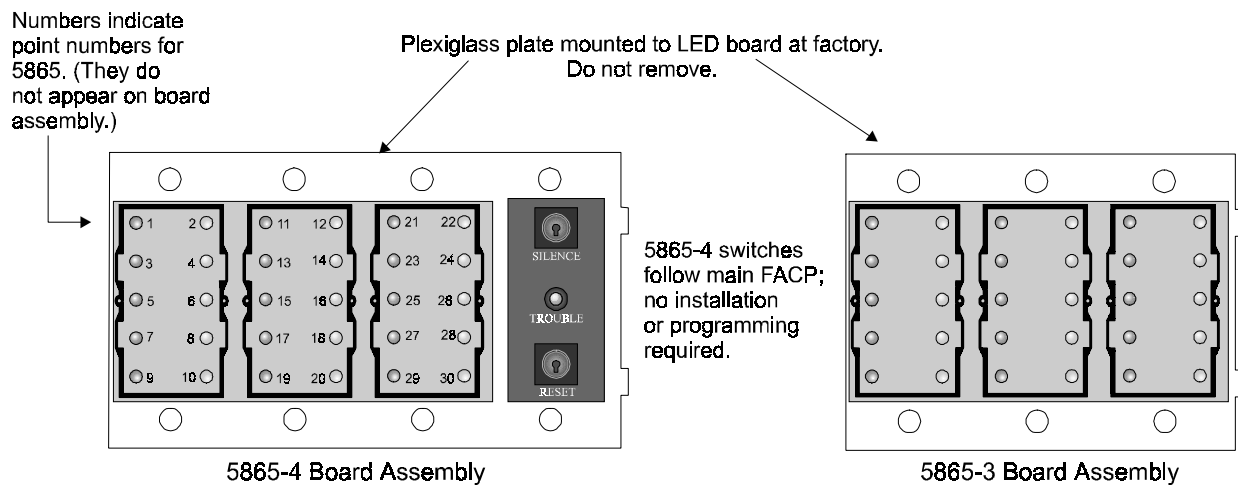


Figure 4-24 5865-3 and 5865-4 Assembly (front view)

4.9.1 FACP Connection

The 5865 connects to the panel via the SBUS. Make connections as shown in Figure 4-25. After the 5865 is connected to the panel, it must be added to the system. This programming step is described in Section 4.10.

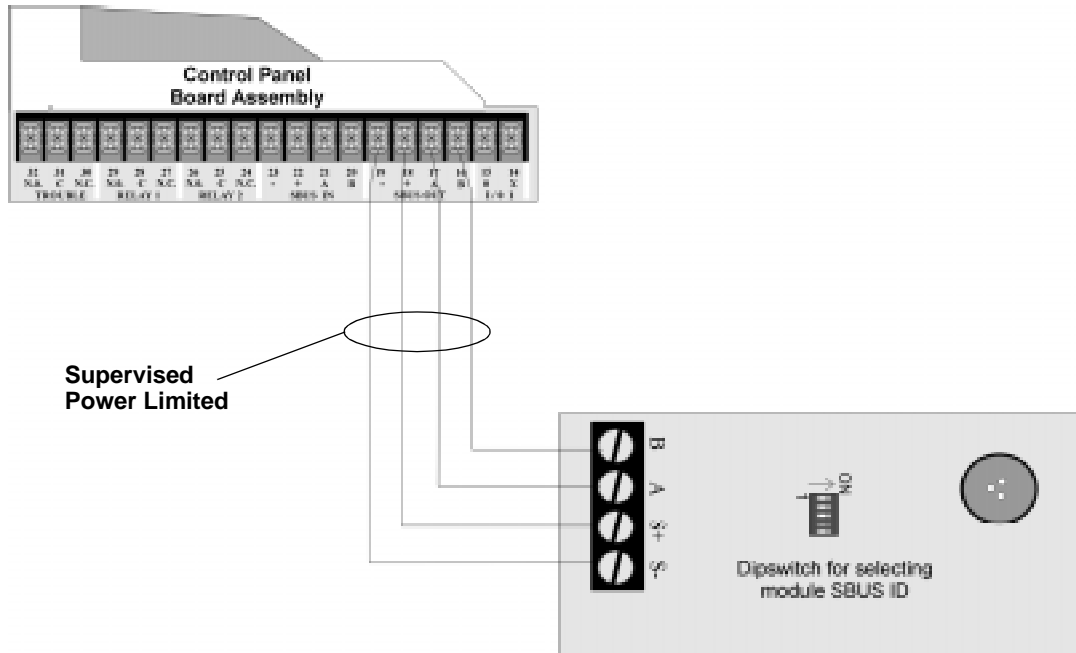


Figure 4-25 5865 Connection to the FACP

4.9.2 5865 Mounting

Mount the 5865-4 to a standard 4-gang electrical box. Mount the 5865-3 to a standard 3-gang electrical box. In Figure 4-26, the 5865-4 attached to a 4-gang box is used as an example.

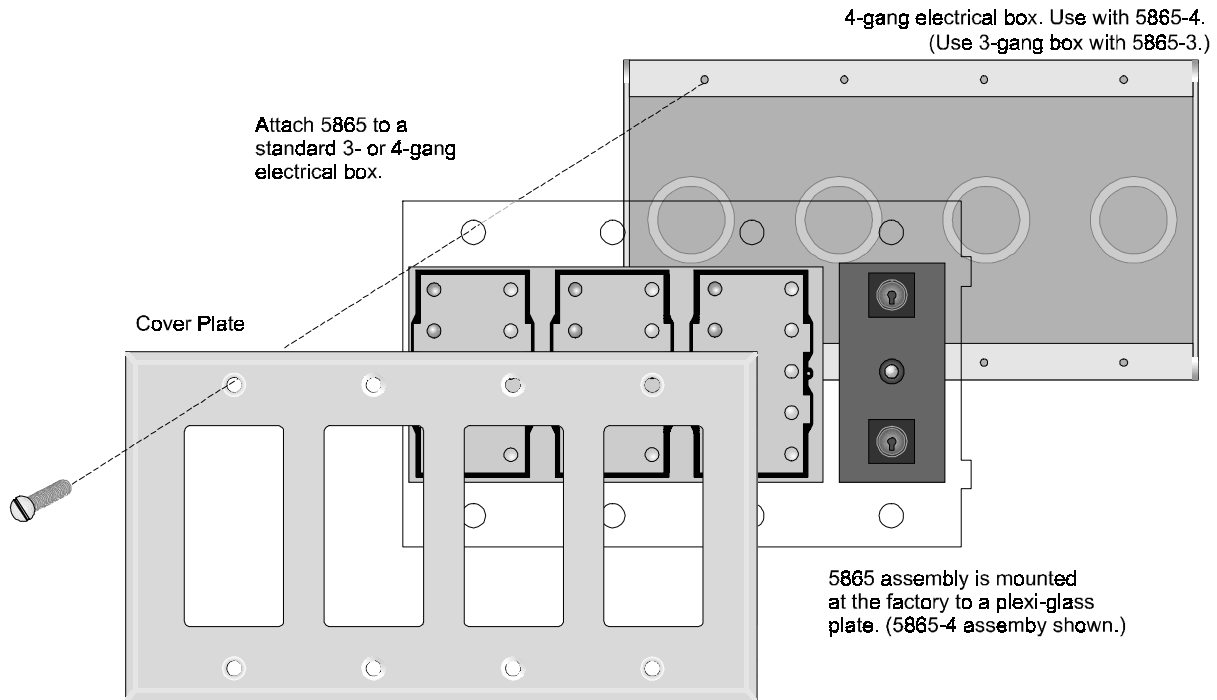


Figure 4-26 5865 Mounting Example

The 5865 ships with a set of zone description labels that can be inserted into the 5865 board assembly. These labels can be used in a typewriter or can be written on by hand.

Slide the labels under the plexiglass as shown in Figure 4-27. The LEDs will show through the label when illuminated.

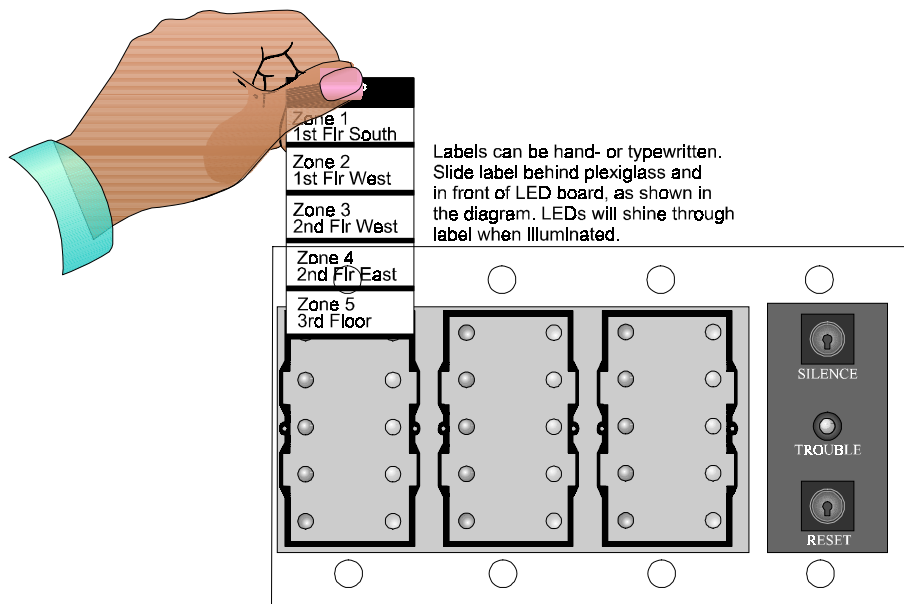


Figure 4-27 Inserting Zone Description Labels

4.10 Configuring Modules

This section describes how to configure any system hardware modules that have been added to the system.

4.10.1 Assigning Module IDs

When installing a hardware module (such as, 5815XL, 5824, 5860, 5895XL, 5865-3 or 5865-4), you must use the dipswitches on the module to assign an ID# to the module.

Figure 4-28 shows all possible dipswitch positions and their correlation to a numerical ID. For example, to select ID 2, place dipswitch 2 in the up position.

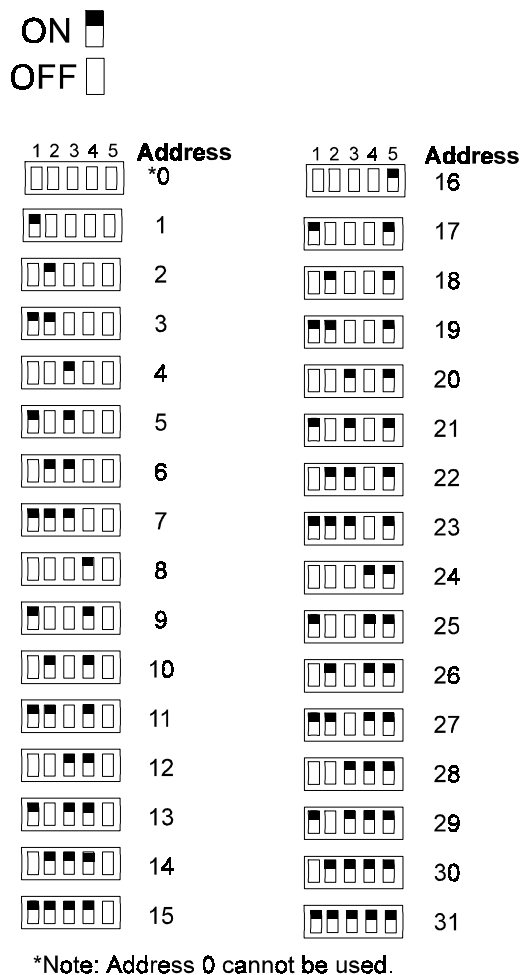


Figure 4-28 Possible module addresses

Refer to Section 7.1 to edit, add, delete, and view module list.

4.11 Telephone Connection

Connect the telephone lines as shown in Figure 4-29. The Model 7860 phone cord is available from Silent Knight for this purpose.

A number of programmable options are available for customizing telephone lines. These options are described in Section 7.5.

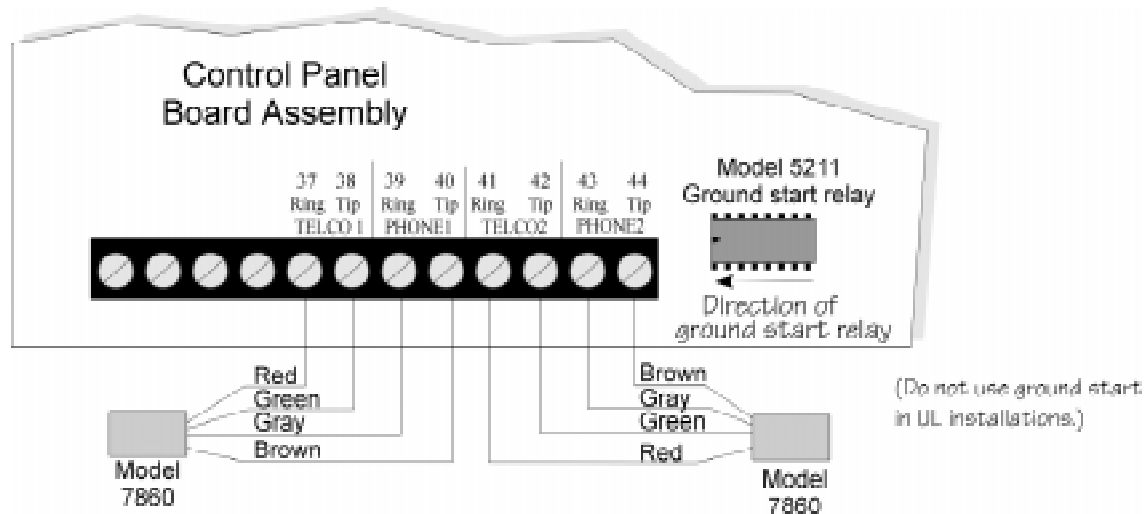


Figure 4-29 Connection of Telephone Lines

4.11.1 Ground Start Relay (Model 5211)

Note: Do not use ground start in UL installations.

If you are using the ground start telephone network, you must use the Model 5211 Ground Start Relay (ordered separately).

1. Install the relay as shown in Figure 4-29.
2. Enable ground start through programming. See Section 7.5.2.6 for instructions.

4.12 Flexputs™ I/O Circuits

The six Flexput™ circuits are an innovative and versatile feature of the control panel. They can be used as: Class A or B notification circuits, Class A or B initiation circuits (either 2 or 4 wire detectors), or as auxiliary power (resettable, continuous, or door holder).

This section of the manual explains how to install conventional notification appliances and initiating devices to be used with the system.

4.12.1 Conventional Notification Appliance

This sub-section of the manual explains how to install conventional notification appliances for Class A (Style Z) and Class B (Style Y) configurations.

4.12.1.1 Class B Notification Wiring

You must use an appliance from the list of compatible appliances in the Appendix A at the back of this manual.

To install a Class B notification appliance circuit:

1. Wire Class B Notification appliances as shown in Figure 4-30.
2. Configure the circuit through programming (see Section 7.4).

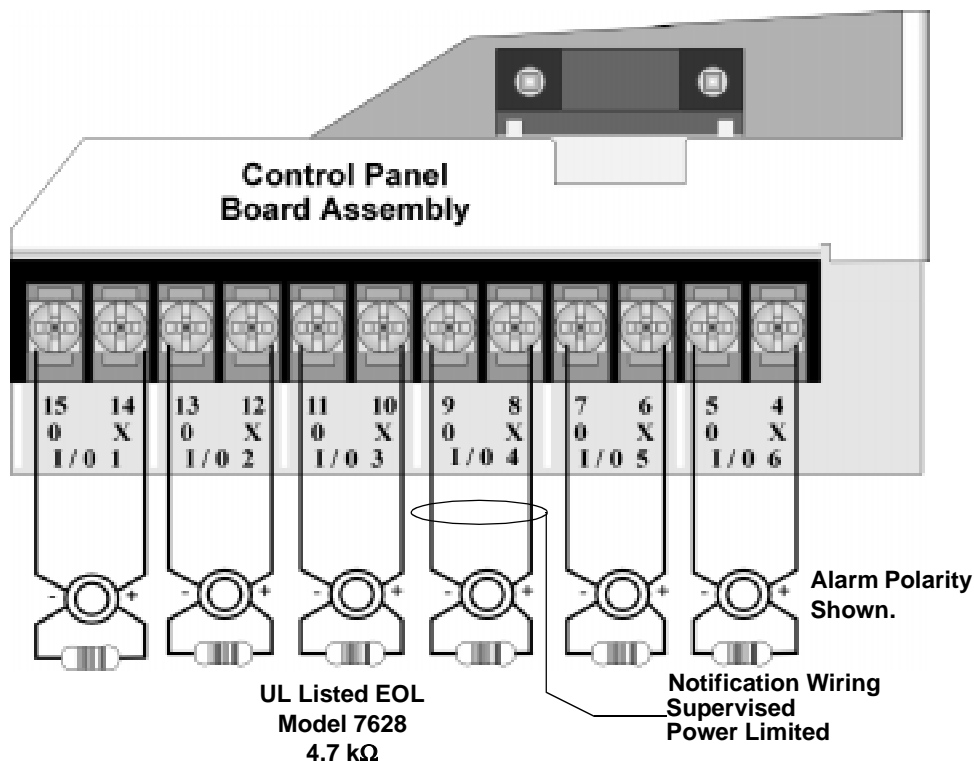


Figure 4-30 Class B Notification Appliance Circuit Wiring

4.12.1.2 Class A Notification Wiring

You must use an appliance from the list of compatible appliances in the Appendix at the back of this manual.

To install a Class A notification appliance circuit:

1. Wire the Class A notification appliances as shown in Figure 4-31.
2. Configure the circuit for Class A in programming (see Section 7.4).

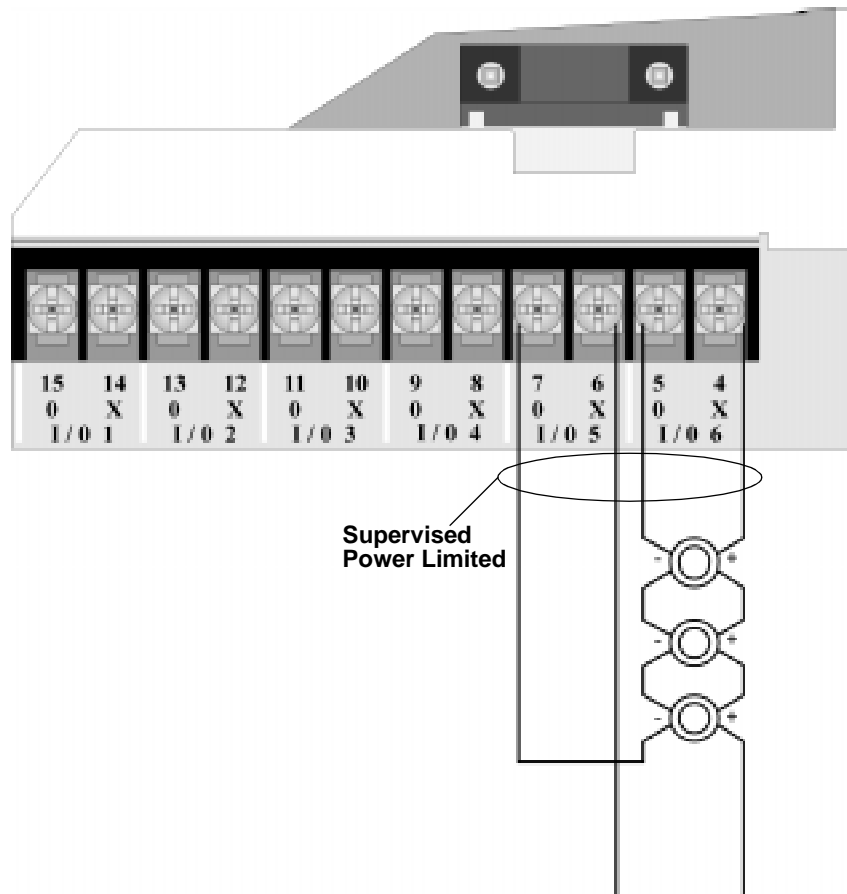


Figure 4-31 Class A Notification Appliance Circuit Configuration

Note: In programming any point that uses multiple Flexput circuits, the lowest Flexput circuit number is used to refer to the circuit pair. For example, Figure 4-31 uses both Flexput circuit 5 and 6, so in programming it would be referred to as point 5.

4.12.2 Conventional Input Switch Circuits

This section of the manual explains how to install conventional initiating devices for Class A (Style D) or Class B (Style B) configurations.

4.12.2.1 Class B Inputs

You can connect conventional Class B switches, such as waterflow switches and pull stations, directly to the Flexput circuits of the control panel.

To install a Class B switch:

1. Wire the Class B switch as shown in Figure 4-32.
2. Configure the circuit through programming (see Section 7.4).

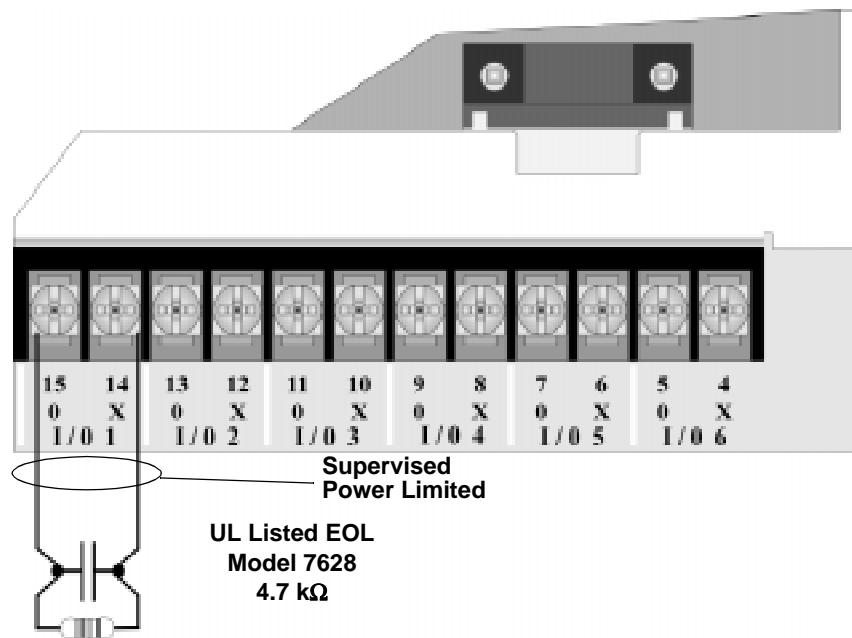


Figure 4-32 Class B Input Switches

4.12.2.2 Class A Inputs

You can connect conventional Class A switches, such as waterflow switches and pull stations, directly to the Flexput circuits of the control panel.

To install a Class A switch:

1. Wire the Class A switch as shown in Figure 4-33.
2. Configure the circuit through programming (see Section 7.4).

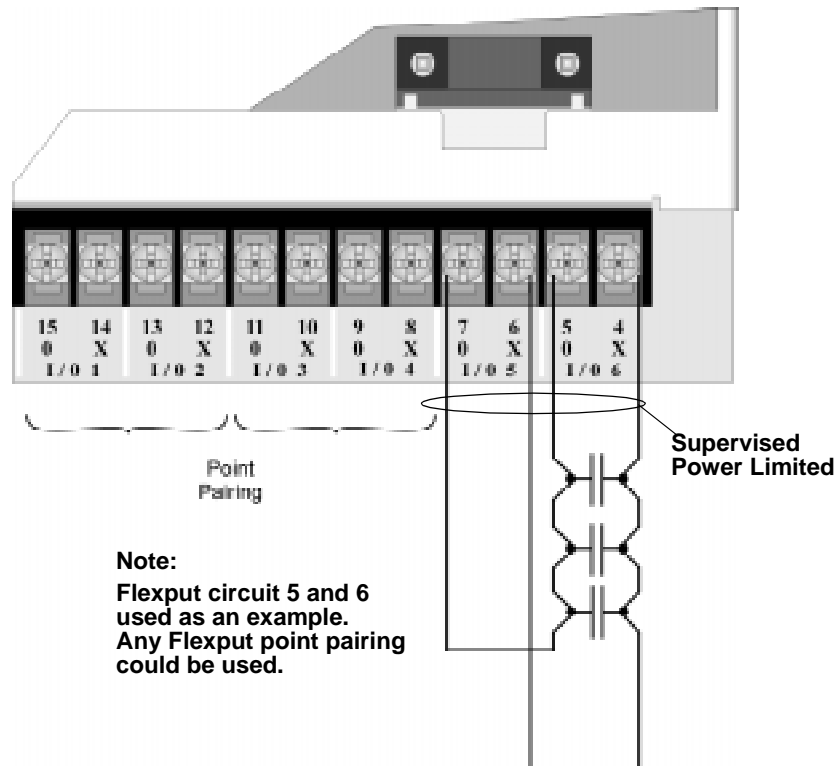


Figure 4-33 Class A initiating Switches

Note: In programming any point that uses multiple Flexput circuits, the lowest Flexput circuit number is used to refer to the circuit pair. For example, Figure 4-33 uses both Flexput circuit 5 and 6, so in programming it would be referred to as point 5.

4.12.3 Installing 2-Wire Smoke Detectors

Any compatible U.L. listed two-wire smoke detector can be used with the control panel (see Appendix A for list of compatible smoke detectors). Figure 4-34 and Figure 4-35 illustrate how to connect a UL listed 2-wire detector to the control panel.

4.12.3.1 Installing 2-Wire Class B Smoke Detectors

To install a Class B two-wire smoke detector, wire as shown in Figure 4-34.

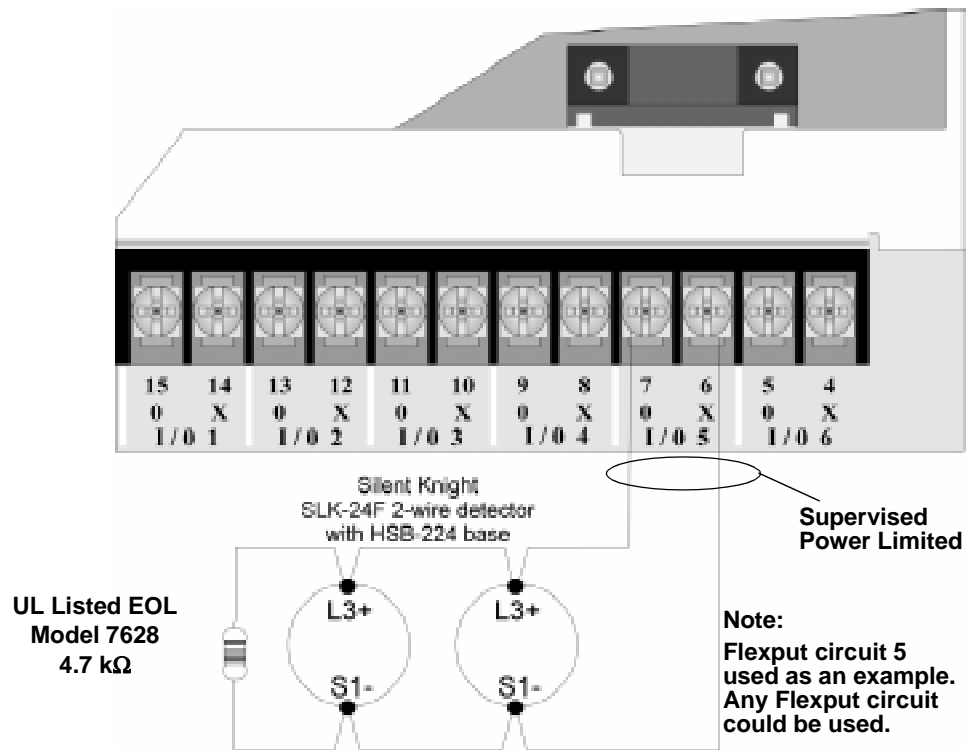


Figure 4-34 Two-Wire Class B Smoke Detector

4.12.3.2 Installing 2-Wire Class A Smoke Detector

To install a Class A two-wire smoke detector, wire as shown in Figure 4-35.

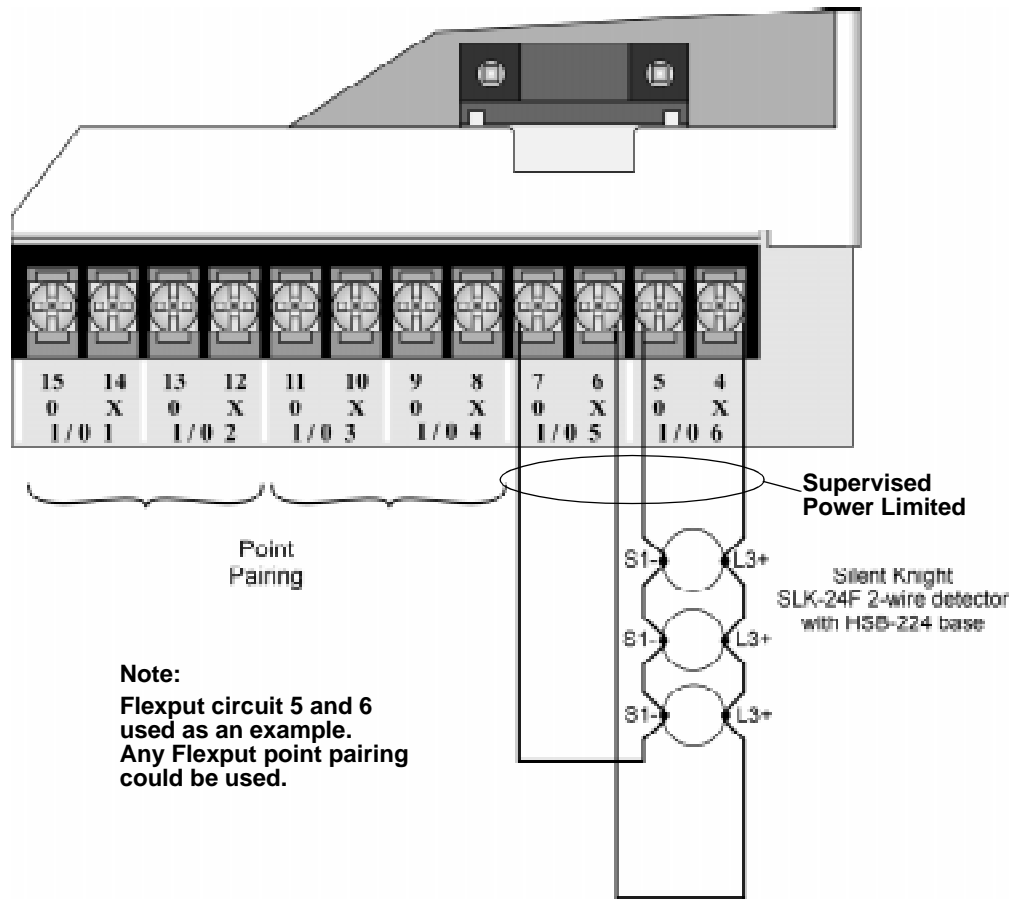


Figure 4-35 Two-Wire Class A Smoke Detector Connections

Note: In programming any point that uses multiple Flexput circuits, the lowest Flexput circuit number is used to refer to the circuit pair. For example, Figure 4-35 uses both Flexput circuit 5 and 6, so in programming it would be referred to as point 5.

4.12.4 Installing 4-Wire Smoke Detectors

Any compatible U.L. listed four-wire smoke detector can be used with the control panel (see Appendix A for list of compatible smoke detectors). Figure 4-34 and Figure 4-35 illustrate how to connect a UL listed four-wire detector to the control panel.

4.12.4.1 Installing a Class B 4-Wire Smoke Detector

Figure 4-36 illustrates how to install a 4-wire Class B smoke detector.

Conventions used for wiring 4-wire Class B loops:

1. Up to three Class B 4-wire smoke detector loops can be connected to the control panel at once.
2. Each Class B loop input is paired with a unique power source as shown in Figure 4-36.
3. Each loop gets smoke power from the even numbered Flexput circuit and the contact input is connected to the odd numbered Flexput circuit.

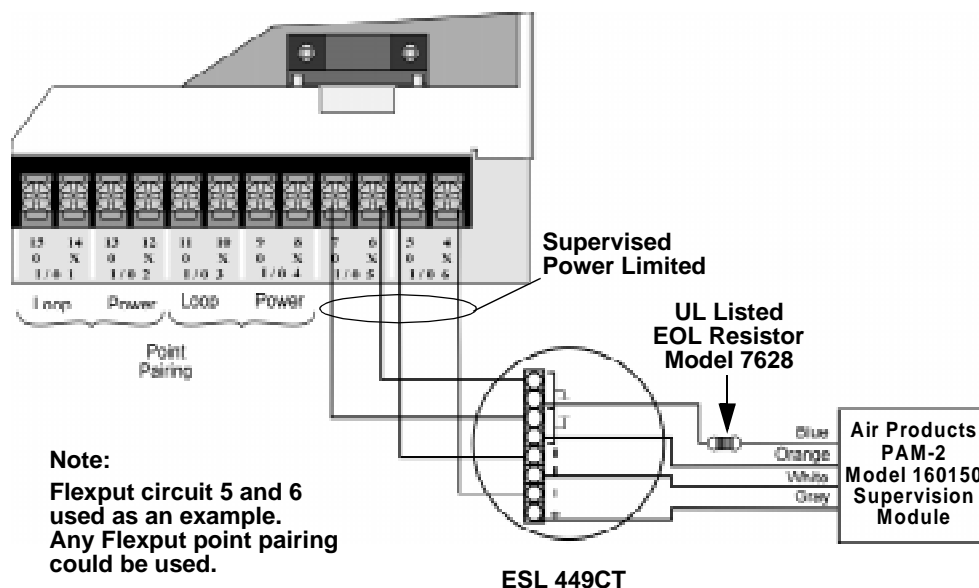


Figure 4-36 Class B 4-Wire Smoke Detector Connections

Note: In programming any point that uses multiple Flexput circuits, the lowest Flexput circuit number is used to refer to the circuit pair. For example, Figure 4-36 uses both Flexput circuit 5 and 6, so in programming it would be referred to as point 5.

4.12.4.2 Installing 4-Wire Class A Smoke Detectors

Figure 4-37 illustrates how to install 4-wire Class A detectors.

Conventions used for wiring 4-wire Class A loops:

1. Up to two Class A 4-wire loops can be connected to the control panel at once.
2. Smoke power is supplied to each Class A loop as shown in Figure 4-37.

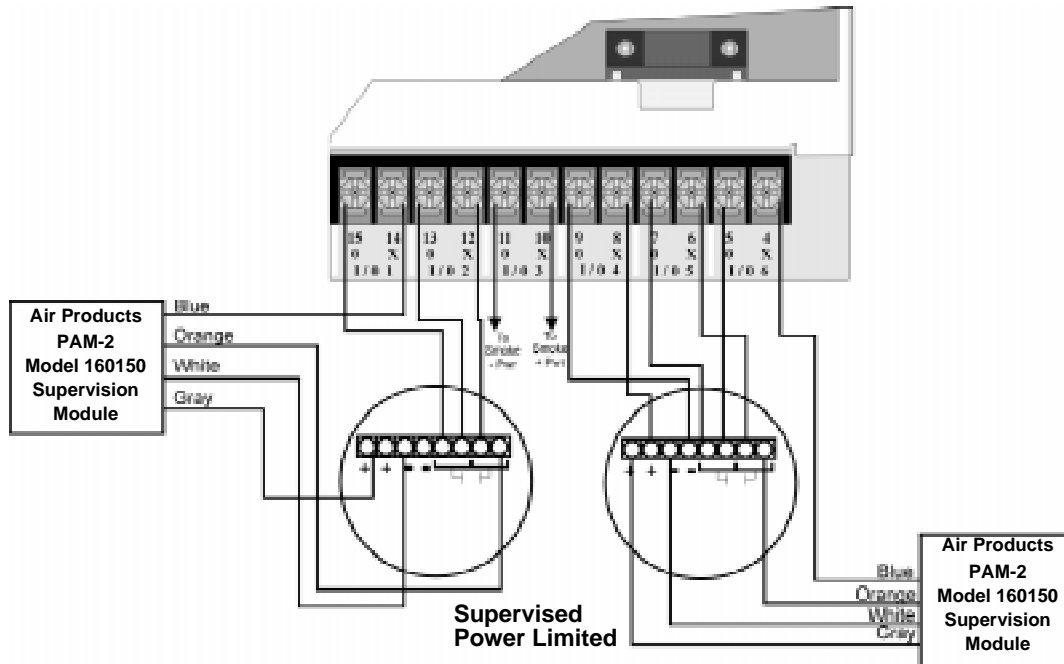


Figure 4-37 Class A 4-Wire Smoke Detector Connections

Note: In programming any point that uses multiple Flexput circuits are always referred to as the lowest Flexput circuit number used. For example, Figure 4-37 uses Flexput circuits 1, 2, 3 together and 4, 5, 6 together. In programming (1, 2, 3) would be referred to as point 1, and (4, 5, 6) would be referred to as point 4.

4.12.5 Auxiliary Power Installation

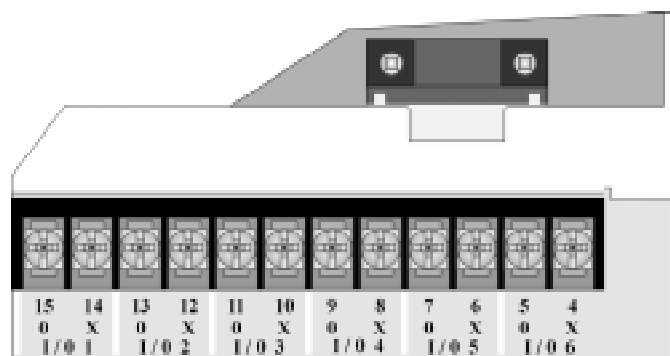
Flexput Circuits 1-6 on the control panel can be used as auxiliary power circuits (see also Section 5.9.5). The three types of auxiliary power available are:

- Door Holder (see section 4.12.5.1)
- Constant (see section 4.12.5.2)
- Resettable Power (see section 4.12.5.3)

Auxiliary power circuits are power limited. Each circuit can source up to 3A (total current for all Flexput circuits must not exceed 5A).

To install an auxiliary power circuit:

1. Wire the Flexput circuit(s) that will be used for auxiliary power. See Figure 4-38 for location of Flexput circuits.
2. Configure the auxiliary power output through programming (see section 7.4).



When used as auxiliary power, terminals labeled "0" are negative, terminals labeled "X" are positive.

Figure 4-38 Flexput Circuit Location

4.12.5.1 Door Holder Power

Door holder power is intended for fire door applications. When there are no alarms in the system and the panel has AC power, door holder circuits have 24-volt power present at their terminals. Any alarm will cause power to disconnect. Power will be re-applied when the system is reset. If AC power is off for more than 15 seconds, the auxiliary door holder power will be disconnected to conserve the battery backup. When AC power is restored, power is immediately restored to the door holder circuits.

Use a UL listed door holder ESL DHX-1224, for this application.

4.12.5.2 Constant Power

Use constant power for applications that require a constant auxiliary power source. Power is always present at Constant circuits.

4.12.5.3 Resettable Power

Resettable power is typically used to power beam detectors, flame detectors and conventional 4-wire smoke detectors. For circuits selected as Resettable, 24-volt power is always present at the terminals unless a system reset occurs. If a system reset occurs, power is disconnected from the terminals for 30 seconds, then re-applied.

4.13 On-Board Relays (Conventional)

The control panel has two built-in programmable relays and a built-in trouble relay. All relays are Form C rated at 2.5 A @ 24 VDC.

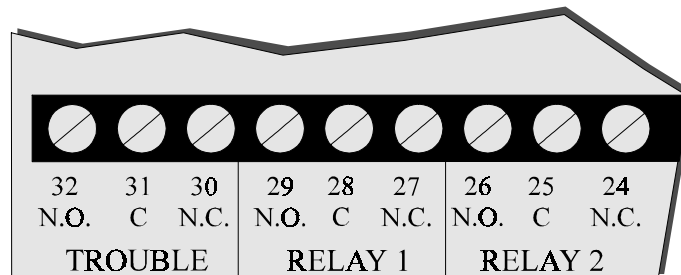


Figure 4-39 Location of Conventional Relay Circuits

4.13.1 Trouble Relay

The control panel has a dedicated Form C trouble relay built into terminals 30-32. The relay provides a normally open and a normally closed contact. The trouble relay will deactivate under any trouble condition.

Note: The N.C. contact is the relay contact that is closed when the panel has power and there are no trouble conditions.

4.13.2 Programmable Relays

The control panel has two Form C programmable relays built into terminals 24-29. Each relay provides a normally open and a normally closed contact.

To install one or two programmable relays, follow these steps.

1. Wire Relay 1 and/or Relay 2 as needed for your application. See Figure 4-39 for the location of the relay terminals.
2. Configure the relay through programming (see section 7.4).

4.14 Keltron Model 3158 Installation

The control panel is compatible with Keltron Model 3158, used for direct connection to a Keltron receiver. The 3158 reports alarms, supervisories, and troubles.

The steps for connecting the 3158 to the control panel. Refer to the 3158 installation instructions for complete information.

1. Wire the 3158 to the control panel as shown in the connection list and Figure 4-40.
2. Wire the 3158 within 20 feet of the control panel. Wiring must be enclosed in conduit.
3. Program control panel Relay 1 for alarm.
4. Program Flexput circuit 5 for alarm.
5. Program Flexput circuit 6 for supervisory.

Table 4-3: Keltron 3158 to Control Panel Connections

Terminal #	Connects To	Terminal #	Connects To
3158 Term. 1	To Keltron receiving equipment	3158 Term. 8	Control panel Term. 28
3158 Term. 2	To Keltron receiving equipment	3158 Term. 9	Control panel Term. 5
3158 Term. 3	Earth ground	3158 Term. 10	Control panel Term. 4
3158 Term. 4	Not used; no connection.	Control panel Term. 6	Control panel Term. 29
3158 Term. 5	Control panel Term. 18	Control panel Term. 28	Control panel Term. 31
3158 Term. 6	Control panel Term. 19	Control panel Term. 29	Control panel Term. 30
3158 Term. 7	Control panel Term. 7		

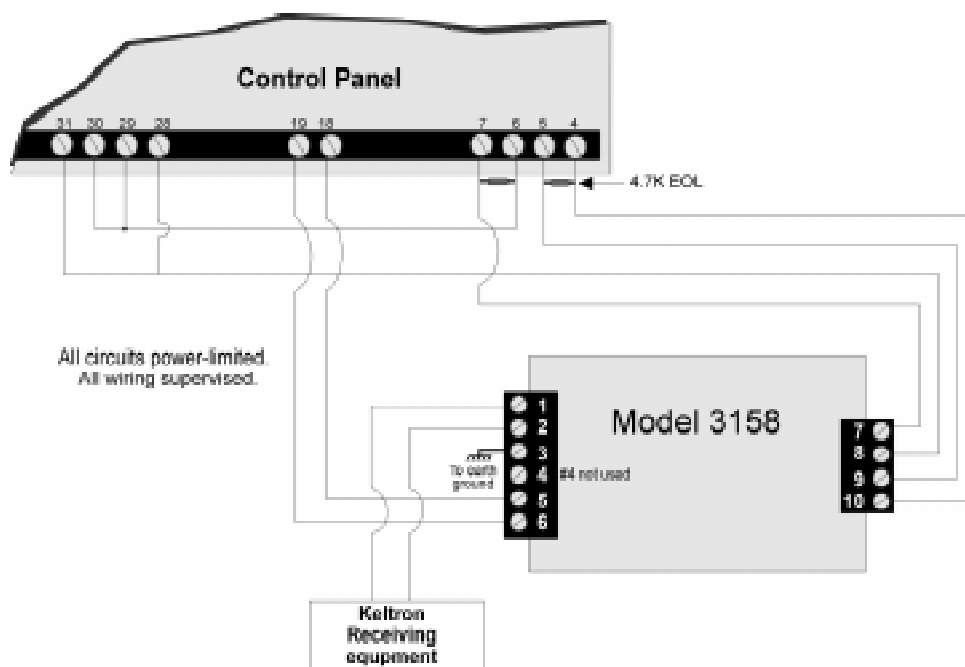


Figure 4-40 Keltron 3158 Connection to Control Panel

4.15 Model 5220 Direct Connect Module

The 5220 Direct Connect Module can be used with the control panel to meet NFPA 72 standards. The 5220 requires four connections to the control panel and provides outputs for city box and polarity reversal applications. The 5220 cannot be used for sprinkler supervisory.

The 5220 provides a current that reverses polarity during an alarm or removes current during a trouble condition.

Figure 4-41 Shows the specific components of the 5220 module which will be used for installation.

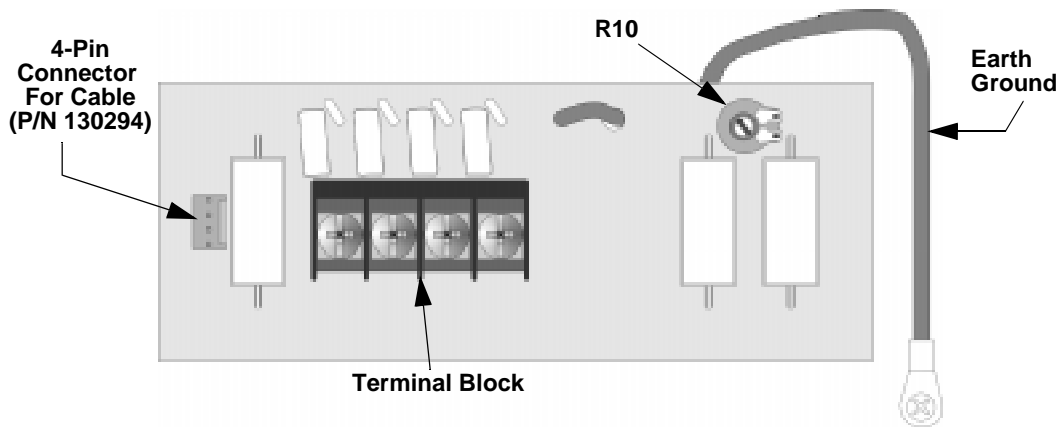


Figure 4-41 5220 Components

4.15.1 5220 Electrical Specifications

T shows the electrical specifications for the 5220 for different wiring configurations.

Table 4-4: 5220 Electrical Specifications

Wiring Configuration	Standby Current	Alarm Current	Comment
City Box	*0	1 Amp for 1 second	See Section 4.15.2 for wiring diagram.
Polarity Reversal	100 mA	100 mA	See Section 4.15.3 for wiring diagram.

* Notification supervision current accounted for in control panel draw.

4.15.2 City Box Connection

This section describes how to connect the control panel to a municipal fire alarm box or “city box” as required by NFPA 72 Auxiliary Protected Fire Alarm systems for fire alarm service. The city (master) box is an enclosure that contains a manually operated transmitter used to send an alarm to the municipal communication center which houses the central operating part of the fire alarm system.

The maximum coil and wire resistance (combined) must not exceed 30 ohms.

To install the 5220 for city box connection:

1. Use one of the knockouts on the right side of the control panel to connect the 5220 using a short piece of conduit (must not exceed 20 feet in length).
2. Wire the 5220 to the control panel as shown in Figure 4-42. This drawing also shows how to connect the city box coil to terminals 3 and 4 on the 5220. Do not install an EOL resistor in the terminals of the Flexput circuit used for this application.
3. Connect earth ground wire to the 5220 chassis with mounting screw.
4. Program the Flexput circuit used as a notification circuit, continuous and non-silencing. Refer to Section 7.4.1 for zone grouping and mapping.

It is not possible to reset the remote indication until you clear the condition and reset the control panel.

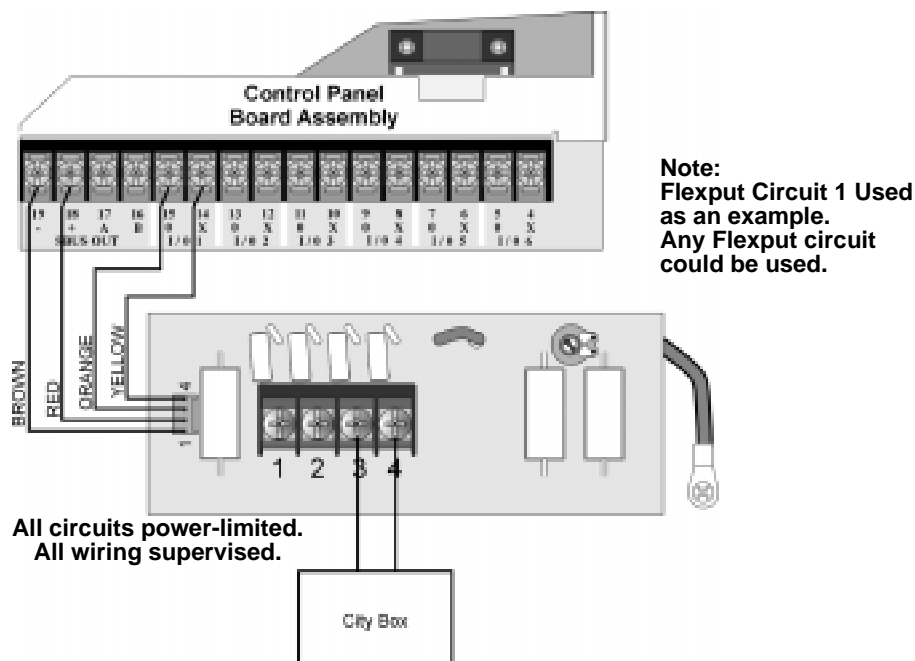


Figure 4-42 City Box Connection

4.15.3 NFPA 72 Polarity Reversal

When the 5220 is wired and programmed for polarity reversal, it reports alarm and trouble events to a remote site. Alarms will override trouble conditions and it will not be possible to reset the remote indicator until the condition is cleared and the control panel is reset.

If an alarm condition occurs, the alarm relay will close, overriding the trouble condition.

To install the 5220 for polarity reversal, follow the steps below:

1. Locate the knockout on the right side of the control panel cabinet to connect the 5220 using a short piece of conduit (must not exceed 20 feet in length).
2. Wire the 5220 to the control panel using the four-wire pigtail provided as shown in Figure 4-43. This diagram also shows how to connect the 5220 to the remote indicator. Do not install an EOL resistor in the terminals of the Flexput circuit used for this application.
3. Connect earth ground wire to the 5220 chassis with mounting screw.
4. Program the Flexput circuit used as a notification circuit, continuous and non-silencing. Refer to Section 7.4.1 for zone grouping and mapping.
5. If necessary, adjust loop current using the potentiometer (R10) on the 5220 board (see Figure 4-41). Normal loop current is 2-to-8 mA with a 1k ohm remote station receiving unit. Maximum loop resistance is 3k ohm.

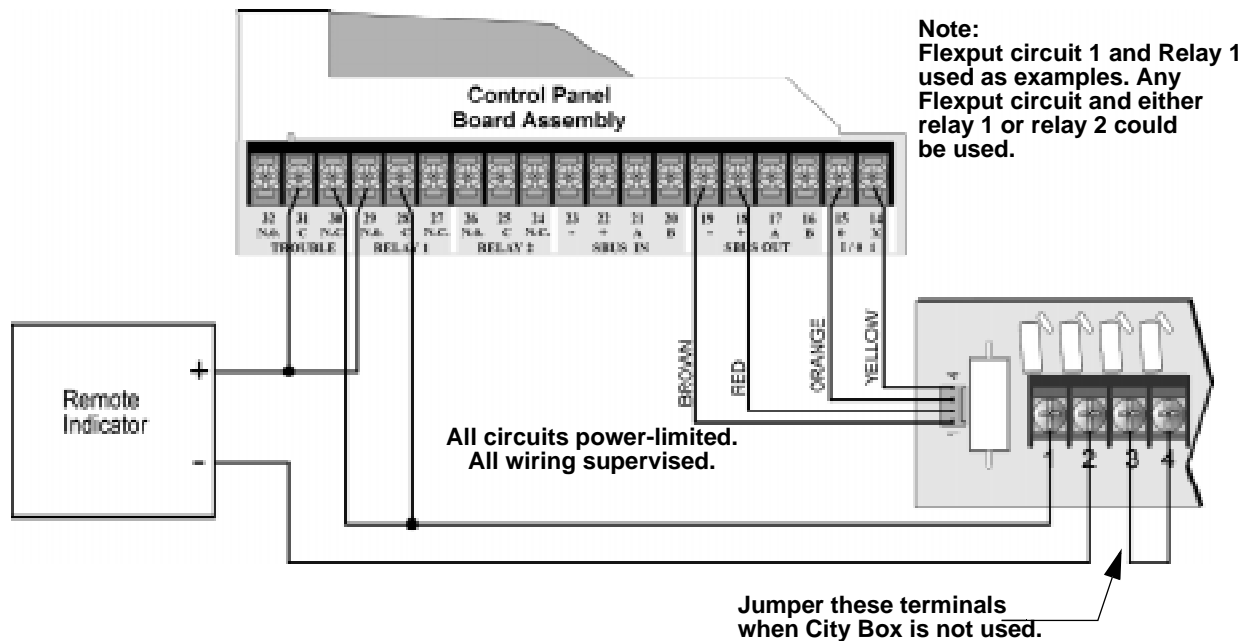


Figure 4-43 Polarity Reversal Connection

Section 5

SLC Device Installation

Caution

To avoid the risk of electrical shock and damage to the unit, power should be OFF at the control panel while installing or servicing.

5.1 Types of SLC Devices

The following types of SLC devices can be used with the system.

- *Model SD500-AIM Input Module (switch input), standard size, dipswitch configurable
- *Model SD500-MIM Mini Input Monitor Module (switch input), small size, dipswitch configurable. Fits in single-gang box with manual pull station switch.
- *Model SD500ARM Addressable Relay Module, dipswitch configurable
- Model SD505-AHS Heat Sensor
- Model SD505-AIS Ionization Smoke Detector
- Model SD505-APS Photoelectric Smoke Detector
- Model SD505-ADH Duct Housing (used with SD505-AIS or SD505-APS smoke detectors)
- Model SD500-ANM Addressable Notification Module

* *Indicates replacement for earlier model. SD500-AIM replaces SD500-FRCM-4; SD500-MIM replaces SD500-FRCM; SD500-ARM replaces SD505-ARM. Earlier models are compatible with the panel but are no longer manufactured by Silent Knight. Contact Silent Knight if you need information about these models.*

5.2 Maximum Number of Devices

A total of 381 analog addressable devices can be used with the system. 127 devices can be attached to the main system. The optional Model 5815XL SLC Expander can add another 127 devices. Up to two 5815XLs can be added to the main system to achieve the 381 point capacity.

5.3 Wiring Requirements for SLC Devices

The following information applies to all SLC devices. Refer to the section that describes the type of device you are installing for details.

5.3.1 Wiring 5815XL in Style 4 (Class B) Configuration

No special wire is required for addressable loops. The wire can be untwisted, unshielded, solid or stranded as long as it meets the National Electric Code 760-51 requirements for power limited fire protective signaling cables.

Maximum wiring resistance is 50 ohms.

Maximum loop length depends on the wire gauge.

Wire Gauge	Max. Distance
22 AWG	1500 feet
18 AWG	3900 feet
16 AWG	6200 feet
14 AWG	10,000 feet

Figure 5-1 and Figure 5-2 show how wire length is determined for out-and-back tap and T-tap style wiring.

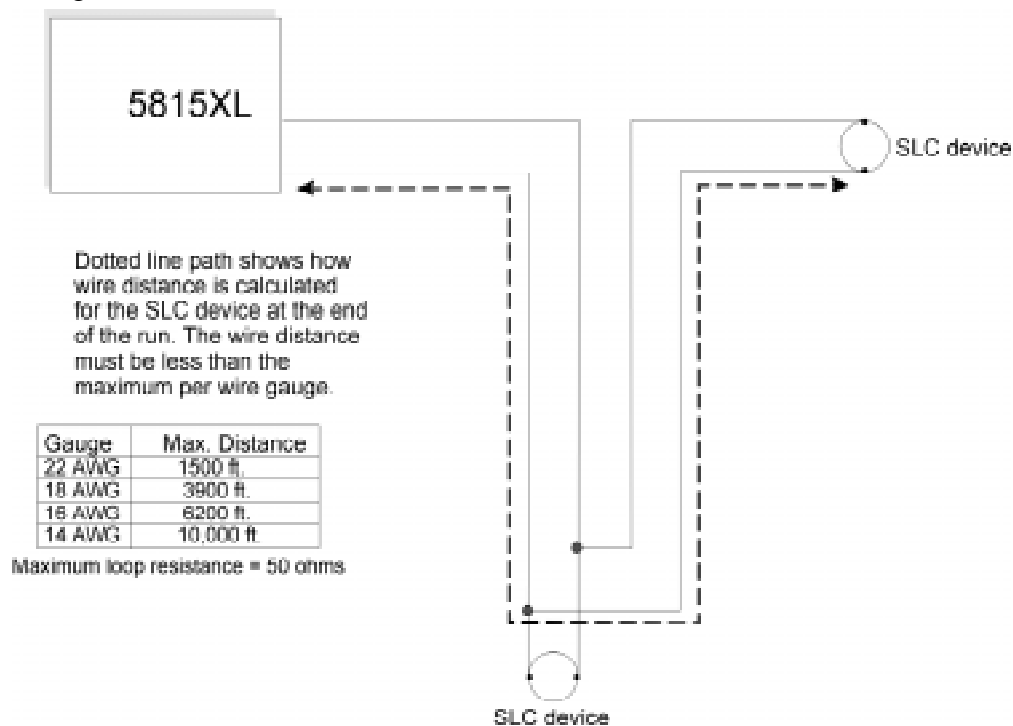


Figure 5-1 Calculating wire run length for a simple out and back tap

When using T-taps, the total length of all taps and the main bus must not exceed 40,000 feet. This requirement must be met in addition to the maximum distance requirements for the various wire gauges.

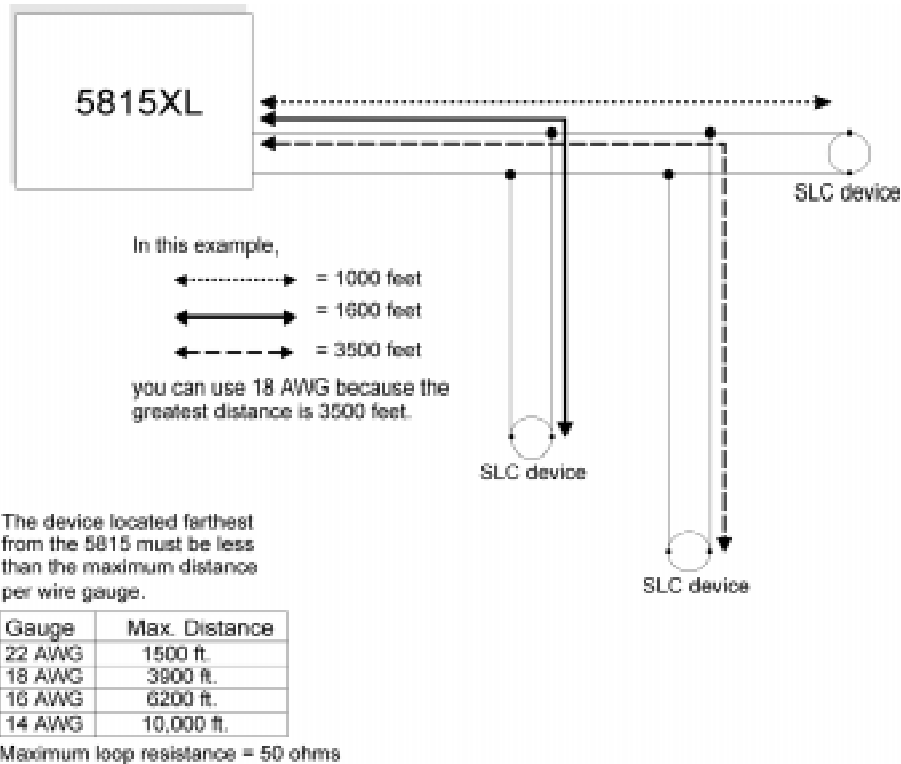


Figure 5-2 Calculating Wire Run Length for a T-tap

5.3.2 Wiring 5815XL in Style 6 (Class A) Configuration

F illustrates how to wire the SLC loop for class A installations.

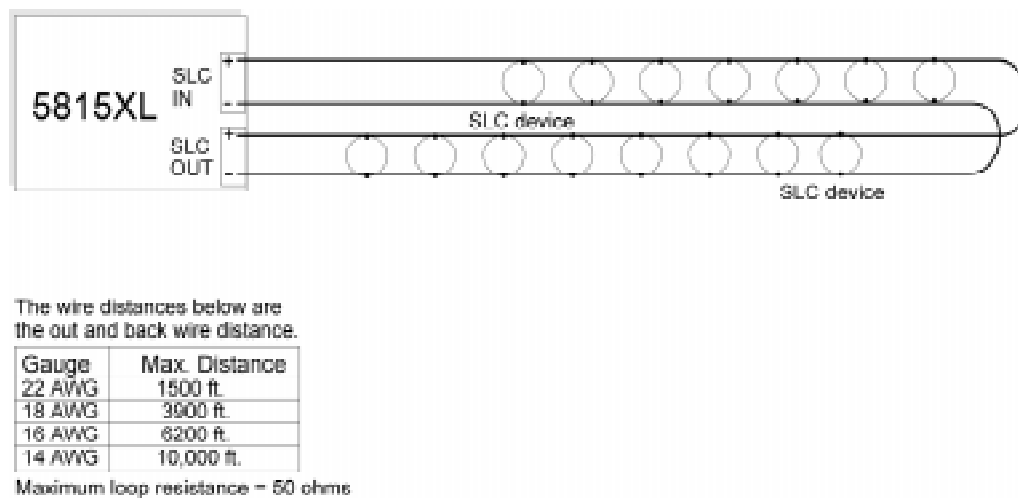


Figure 5-3 Class A SLC Configuration

Note: No t-taps allowed on class A SLC loops.

5.4 Heat and Smoke Detector Installation

The information in this section applies to the following models: SD505-AHS Heat Detector, SD505-AIS Ionization Smoke Detector, and SD505-APS Photoelectric Smoke Detector.

See also Section 5.10 for information on how to address the detectors.

5.4.1 Wiring

1. Wire device bases as shown in Figure 5-4.
2. Set the address for each device as described in Section 5.10.
3. If you are connecting to the main panel, do not connect any devices to terminals 35 and 36. If you are connecting to a 5815XL, do not connect any devices to “SLC IN”.

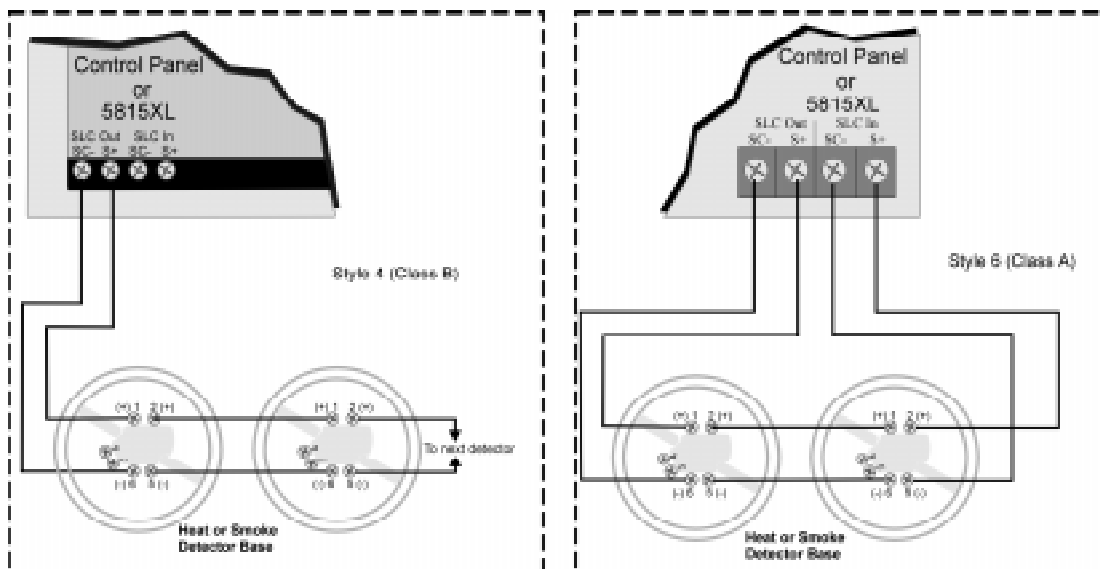


Figure 5-4 Heat or Smoke Detector Connection to the FACP (Class B)

5.5 Duct Detector Installation

Figure 5-5 shows the layout of the SD505-ADH duct housing with a detector base in place, including location of the terminals for connection to the FACP. Figure 5-6 shows wiring in detail.

Address the detector head before attaching it to the base. This procedure is explained in Section 5.10.

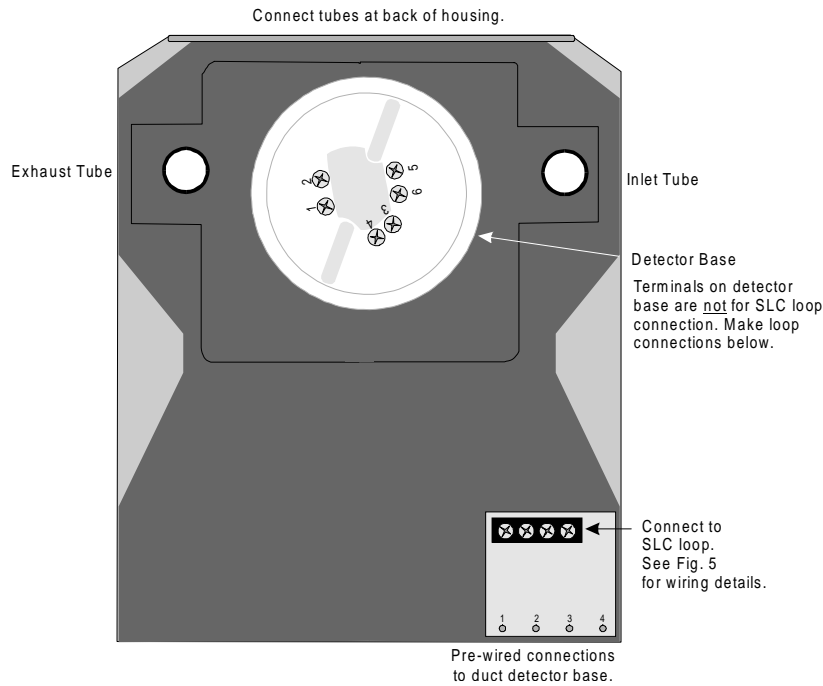


Figure 5-5 Model SD505-ADH Internal View Showing Connector Locations

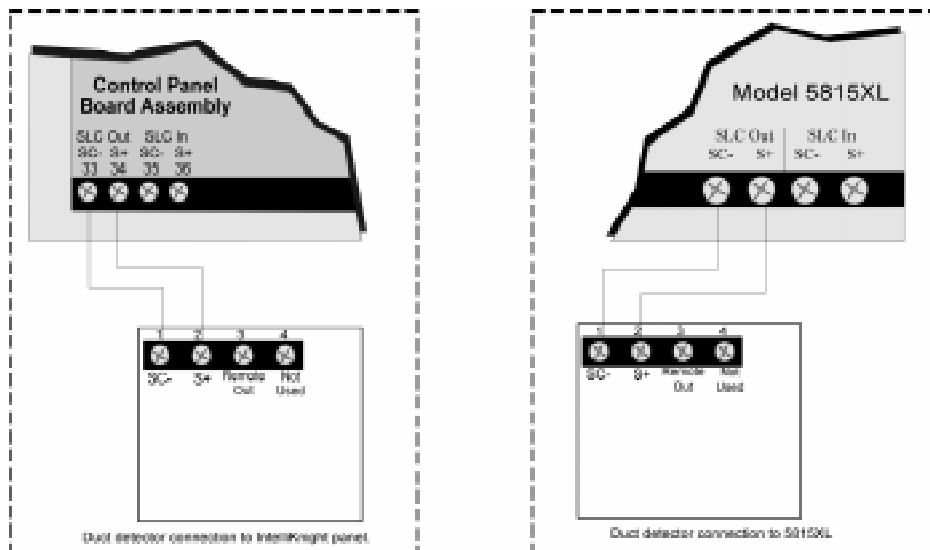


Figure 5-6 Duct Detector Connection to the Control Panel

5.6 Input Monitor Module (SD500-AIM)

Wire and mount the SD500-AIM full-size input module as described in this section (see Figure 5-7 and Figure 5-8). See Section 5.10.2 for information on how to use the on-board dipswitch to select an address for the module.

Wire the monitor modules to the panel or to the 5815XL as shown in Figure 5-7.

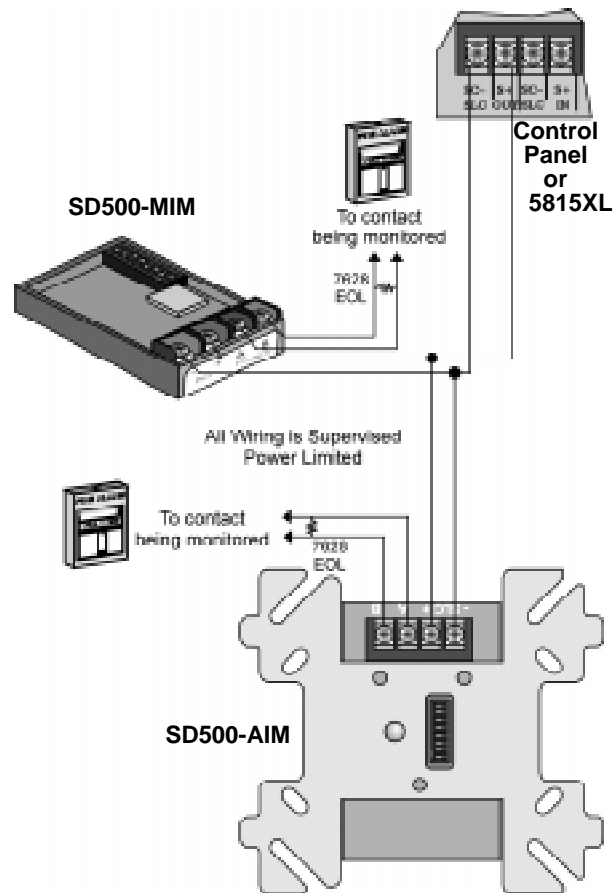


Figure 5-7 SD500-AIM/MIM Input Module Connection to the FACP (Class B)

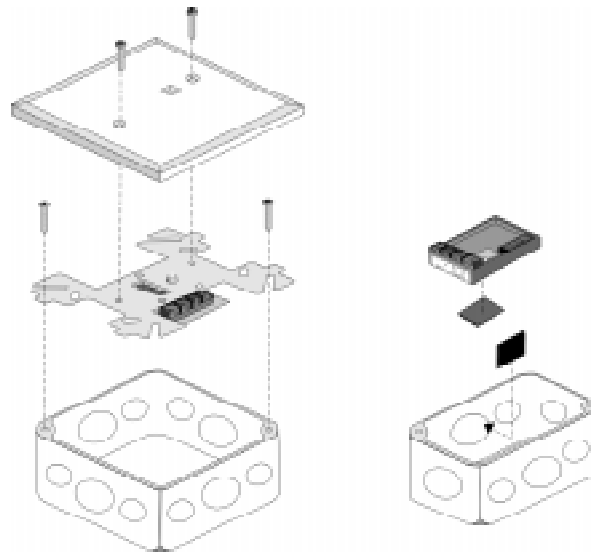


Figure 5-8 SD500-AIM/MIM Input Module Mounting Example

5.7 Mini Input Module (SD500-MIM)

Wire the SD500-MIM Mini Input Module as shown in this section (see Figure 5-7 and Figure 5-8). The SD500-MIM fits inside a single-gang electrical box. See Section 5.10.2 for information on using the on-board dipswitch to select an address for the module.

5.8 Relay Module Installation

The information in this section applies to Model SD500-ARM Relay Modules. See Section 5.10.2 for information on how to use the on-board dipswitch to select an address for the module.

5.8.1 Electrical Specifications

The following is electrical rating information for SD500-ARM relay modules.

Relay Ratings

30 VDC @ 2.0 A Resistive

30 VDC @ 1.0 A Inductive (.6PF)

30 VDC @ 0.6 A (0.35PF) Pilot Duty—Light duty low voltage S.W.

120 VAC @ 0.6 A (0.35PF) Pilot Duty

Connect to power limited sources only.

Note: PF = Power Factor.

5.8.2 Wiring

Wire relay modules to the panel or to the 5815XL as shown in Figure 5-9.

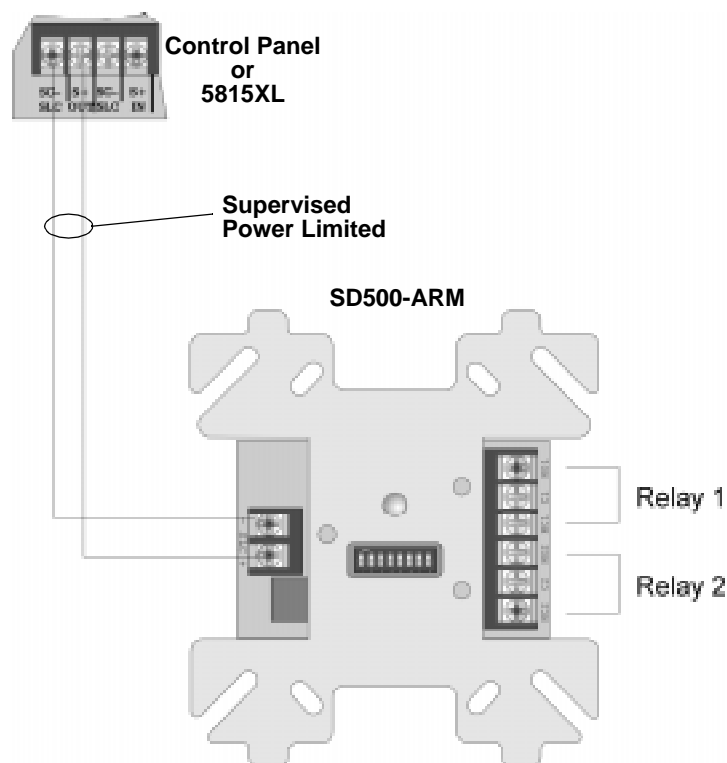


Figure 5-9 Relay Module Connection to the FACP (Class B)

5.9 SD500-ANM Installation Instructions

The SD500-ANM (Addressable Notification Module) is an output accessory module for the Control Panel, which provides one reverse polarity supervised notification appliance circuit. The notification circuit can be configured in either Class A (Style Z) or Class B (Style Y).

5.9.1 SD500-ANM Specification

Table 5-1 list the electrical, physical and environmental specifications of the SD500-ANM.

Table 5-1: SD500-ANM Specs

Specification Parameter		Rating
Operating Temperature:		32° - 120° F (0° - 49° C)
Dimensions:	Length:	4-7/8"
	Width:	4-7/8"
	Depth:	7/8"
Operating Voltage:		24 VDC
Auxiliary Power Circuit Current:	Alarm:	56 mA
	Standby:	6 mA
Notification Appliance Current:		2 A max.
SLC Current:		.55 mA
Max. SLC Loop Resistance:		50 Ω
For indoor use only		

Note: When calculating standby and alarm current with SD500-ANMs there are three components to the current draw work sheet of Table 3-2. The first component is that each SD500-ANM counts as one SLC addressable device for standby and alarm (0.55 mA). The second component is that each SD500-ANM has a 6 mA standby and 56 mA alarm current draw to be included under the auxiliary devices category. The third component is that all notification appliances used with the SD500-ANM must be included under the notification appliances category.

5.9.2 Wiring the SD500-ANM

Note: Installation and wiring of this device must be done in accordance with NFPA 72 and local ordinances.

5.9.2.1 Wiring the SD500-ANM to the 5815XL

The SD500-ANM connection for the 5815XL internal and external are the same. Wire as shown in Figure 5-10.

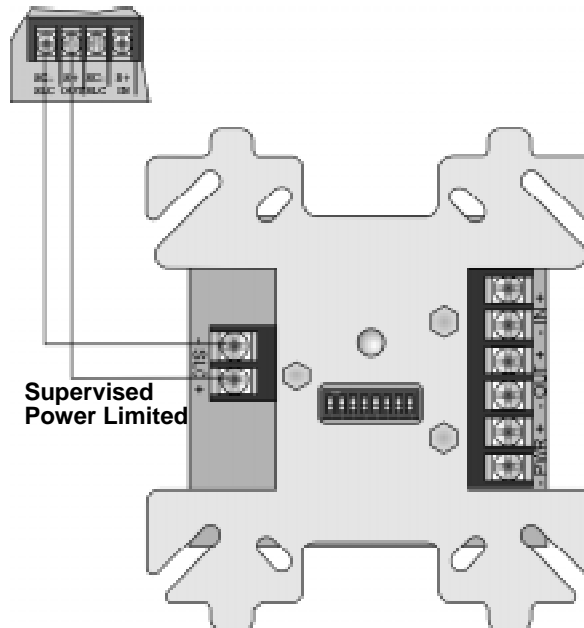


Figure 5-10 : SD500-ANM Connections to the 5815XL

5.9.3 Class B Notification Configuration

Wire Class B notification appliance circuits to the SD500-ANM as shown in Figure 5-11.

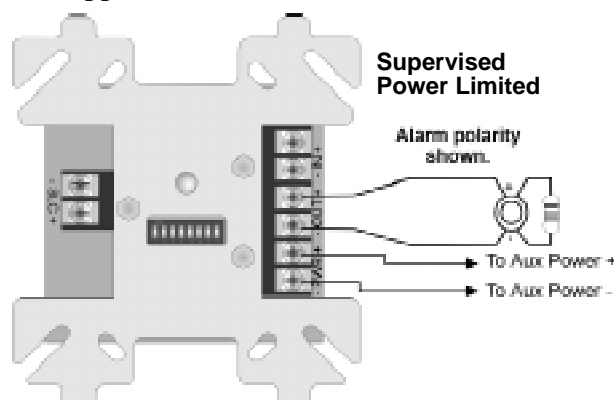


Figure 5-11 : SD500-ANM Class B Notification Wiring

5.9.4 Class A Notification Configuration

Wire Class A notification appliance circuits to the SD500-ANM as shown in Figure 5-12.

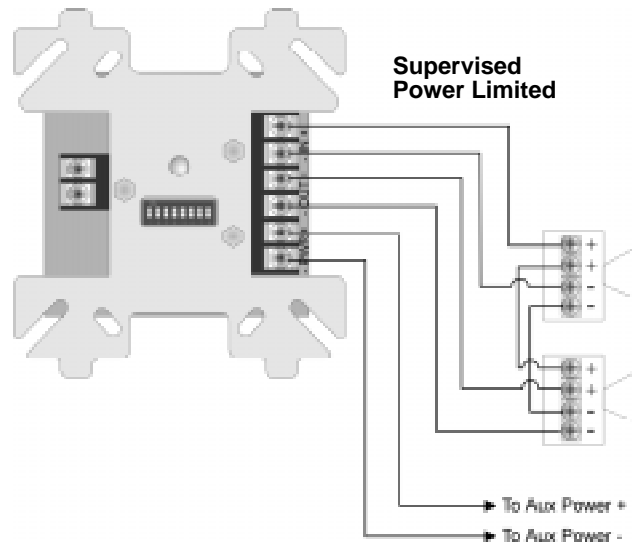


Figure 5-12 : SD500-ANM Class A Notification Wiring

5.9.5 Configuring Flexput™ Circuits for Auxiliary Power

Follow these steps to configure an Flexput circuit for aux power to be used with the SD500-ANM:

1. Wire the PWR terminals of the SD500-ANM to the Flexput terminals using “X” terminals as positive and “O” terminals as negative power. See Figure 5-13.

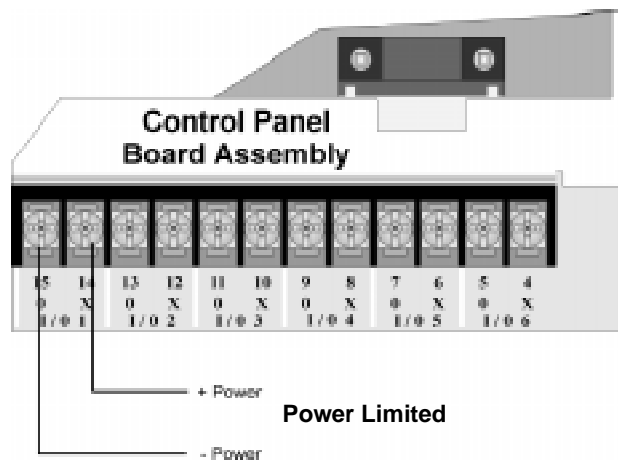


Figure 5-13 : Flexput Auxiliary Power Output

2. Configure the auxiliary power output for constant output through programming (see Section 7.4).

5.10 SLC Device Addressing

5.10.1 EEPROM Addressing

Select addresses for the following models through software as described here:

- Model SD505-AHS Heat Detector
- Model SD505-APS Photoelectric Smoke Detector
- Model SD505-AIS Ionization Smoke Sensor

You must use the Installer Code to perform this task. Here are the steps.

1. Connect a detector base temporarily to the programming terminals as shown in Figure 5-14. (You can use the same base for each detector.)

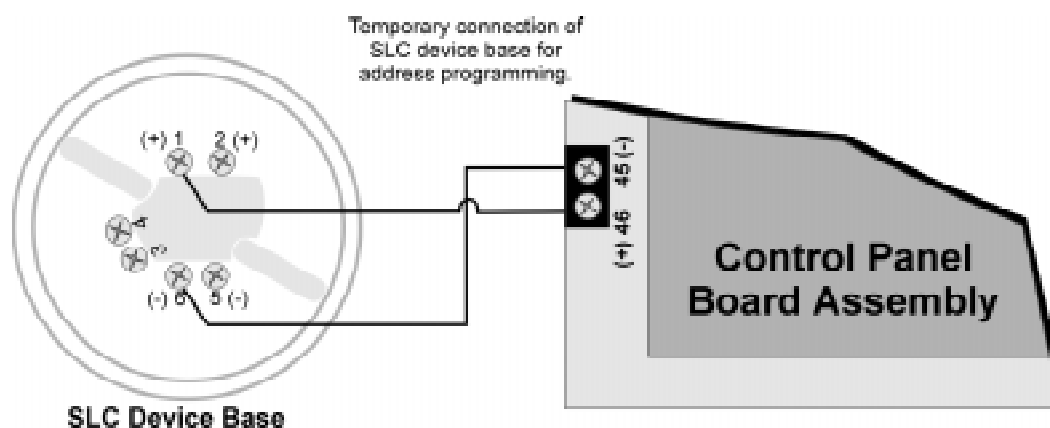


Figure 5-14 Temporary of Detector Base to Panel for Addressing

2. Enter the Installer code.
3. Select **2** for Point Functions.
4. Select **3** for Set SLC Dev Addr. (The panel will go into trouble at this point. You can use the **SILENCE** key to stop the PZT. The trouble will clear automatically when the panel reinitializes when you finish programming.)
5. Select “Yes” by pressing the **▲** up arrow, then press **ENTER**.
6. When the wait message clears, the following options display:
 - 1** for Read Address. Use to read (or check) a single detector’s address.
 - 2** for Write Address. Use to program a single detector’s address.
 - 3** for Seq. Programming. Use to program more than one detector in sequential order.
7. If you are changing addresses, write the programmed address on the back of the device.
8. To exit press **◀** left arrow until fully exited.

5.10.2 Dipswitch Addressing

Input and relay module addresses are set using the dipswitch that appears on the module board. The chart below shows the available addresses. For example, to select address 3, place dipswitches 1 and 2 in the up position. The range of valid addresses is 1-127 (0 is an invalid address).

ON

OFF *Note: Dipswitch position 8 must always be OFF.*

1	2	3	4	5	6	7	8	Address	1	2	3	4	5	6	7	8	Address	1	2	3	4	5	6	7	8	Address	1	2	3	4	5	6	7	8	Address				
<input type="checkbox"/>	<input type="checkbox"/>	<input type="checkbox"/>	<input type="checkbox"/>	<input type="checkbox"/>	<input type="checkbox"/>	<input type="checkbox"/>	<input type="checkbox"/>	0	<input type="checkbox"/>	<input type="checkbox"/>	<input type="checkbox"/>	<input type="checkbox"/>	<input type="checkbox"/>	<input type="checkbox"/>	<input type="checkbox"/>	<input type="checkbox"/>	<input type="checkbox"/>	32	<input type="checkbox"/>	<input type="checkbox"/>	<input type="checkbox"/>	<input type="checkbox"/>	<input type="checkbox"/>	<input type="checkbox"/>	<input type="checkbox"/>	<input type="checkbox"/>	<input type="checkbox"/>	<input type="checkbox"/>	<input type="checkbox"/>	<input type="checkbox"/>	64	<input type="checkbox"/>	<input type="checkbox"/>	<input type="checkbox"/>	<input type="checkbox"/>	<input type="checkbox"/>	<input type="checkbox"/>	<input type="checkbox"/>	96
<input checked="" type="checkbox"/>	<input type="checkbox"/>	<input type="checkbox"/>	<input type="checkbox"/>	<input type="checkbox"/>	<input type="checkbox"/>	<input type="checkbox"/>	<input type="checkbox"/>	1	<input type="checkbox"/>	<input type="checkbox"/>	<input type="checkbox"/>	<input type="checkbox"/>	<input type="checkbox"/>	<input type="checkbox"/>	<input type="checkbox"/>	<input type="checkbox"/>	<input type="checkbox"/>	33	<input type="checkbox"/>	<input type="checkbox"/>	<input type="checkbox"/>	<input type="checkbox"/>	<input type="checkbox"/>	<input type="checkbox"/>	<input type="checkbox"/>	<input type="checkbox"/>	<input type="checkbox"/>	<input type="checkbox"/>	<input type="checkbox"/>	<input type="checkbox"/>	65	<input type="checkbox"/>	<input type="checkbox"/>	<input type="checkbox"/>	<input type="checkbox"/>	<input type="checkbox"/>	<input type="checkbox"/>	<input type="checkbox"/>	97
<input type="checkbox"/>	<input type="checkbox"/>	<input type="checkbox"/>	<input type="checkbox"/>	<input type="checkbox"/>	<input type="checkbox"/>	<input type="checkbox"/>	<input type="checkbox"/>	2	<input type="checkbox"/>	<input type="checkbox"/>	<input type="checkbox"/>	<input type="checkbox"/>	<input type="checkbox"/>	<input type="checkbox"/>	<input type="checkbox"/>	<input type="checkbox"/>	<input type="checkbox"/>	34	<input type="checkbox"/>	<input type="checkbox"/>	<input type="checkbox"/>	<input type="checkbox"/>	<input type="checkbox"/>	<input type="checkbox"/>	<input type="checkbox"/>	<input type="checkbox"/>	<input type="checkbox"/>	<input type="checkbox"/>	<input type="checkbox"/>	<input type="checkbox"/>	66	<input type="checkbox"/>	<input type="checkbox"/>	<input type="checkbox"/>	<input type="checkbox"/>	<input type="checkbox"/>	<input type="checkbox"/>	<input type="checkbox"/>	98
<input checked="" type="checkbox"/>	<input checked="" type="checkbox"/>	<input type="checkbox"/>	<input type="checkbox"/>	<input type="checkbox"/>	<input type="checkbox"/>	<input type="checkbox"/>	<input type="checkbox"/>	3	<input type="checkbox"/>	<input type="checkbox"/>	<input type="checkbox"/>	<input type="checkbox"/>	<input type="checkbox"/>	<input type="checkbox"/>	<input type="checkbox"/>	<input type="checkbox"/>	<input type="checkbox"/>	35	<input type="checkbox"/>	<input type="checkbox"/>	<input type="checkbox"/>	<input type="checkbox"/>	<input type="checkbox"/>	<input type="checkbox"/>	<input type="checkbox"/>	<input type="checkbox"/>	<input type="checkbox"/>	<input type="checkbox"/>	<input type="checkbox"/>	<input type="checkbox"/>	67	<input type="checkbox"/>	<input type="checkbox"/>	<input type="checkbox"/>	<input type="checkbox"/>	<input type="checkbox"/>	<input type="checkbox"/>	<input type="checkbox"/>	99
<input type="checkbox"/>	<input type="checkbox"/>	<input type="checkbox"/>	<input type="checkbox"/>	<input type="checkbox"/>	<input type="checkbox"/>	<input type="checkbox"/>	<input type="checkbox"/>	4	<input type="checkbox"/>	<input type="checkbox"/>	<input type="checkbox"/>	<input type="checkbox"/>	<input type="checkbox"/>	<input type="checkbox"/>	<input type="checkbox"/>	<input type="checkbox"/>	<input type="checkbox"/>	36	<input type="checkbox"/>	<input type="checkbox"/>	<input type="checkbox"/>	<input type="checkbox"/>	<input type="checkbox"/>	<input type="checkbox"/>	<input type="checkbox"/>	<input type="checkbox"/>	<input type="checkbox"/>	<input type="checkbox"/>	<input type="checkbox"/>	<input type="checkbox"/>	68	<input type="checkbox"/>	<input type="checkbox"/>	<input type="checkbox"/>	<input type="checkbox"/>	<input type="checkbox"/>	<input type="checkbox"/>	<input type="checkbox"/>	100
<input checked="" type="checkbox"/>	<input type="checkbox"/>	<input type="checkbox"/>	<input type="checkbox"/>	<input type="checkbox"/>	<input type="checkbox"/>	<input type="checkbox"/>	<input type="checkbox"/>	5	<input type="checkbox"/>	<input type="checkbox"/>	<input type="checkbox"/>	<input type="checkbox"/>	<input type="checkbox"/>	<input type="checkbox"/>	<input type="checkbox"/>	<input type="checkbox"/>	<input type="checkbox"/>	37	<input type="checkbox"/>	<input type="checkbox"/>	<input type="checkbox"/>	<input type="checkbox"/>	<input type="checkbox"/>	<input type="checkbox"/>	<input type="checkbox"/>	<input type="checkbox"/>	<input type="checkbox"/>	<input type="checkbox"/>	<input type="checkbox"/>	<input type="checkbox"/>	69	<input type="checkbox"/>	<input type="checkbox"/>	<input type="checkbox"/>	<input type="checkbox"/>	<input type="checkbox"/>	<input type="checkbox"/>	<input type="checkbox"/>	101
<input type="checkbox"/>	<input type="checkbox"/>	<input type="checkbox"/>	<input type="checkbox"/>	<input type="checkbox"/>	<input type="checkbox"/>	<input type="checkbox"/>	<input type="checkbox"/>	6	<input type="checkbox"/>	<input type="checkbox"/>	<input type="checkbox"/>	<input type="checkbox"/>	<input type="checkbox"/>	<input type="checkbox"/>	<input type="checkbox"/>	<input type="checkbox"/>	<input type="checkbox"/>	38	<input type="checkbox"/>	<input type="checkbox"/>	<input type="checkbox"/>	<input type="checkbox"/>	<input type="checkbox"/>	<input type="checkbox"/>	<input type="checkbox"/>	<input type="checkbox"/>	<input type="checkbox"/>	<input type="checkbox"/>	<input type="checkbox"/>	<input type="checkbox"/>	70	<input type="checkbox"/>	<input type="checkbox"/>	<input type="checkbox"/>	<input type="checkbox"/>	<input type="checkbox"/>	<input type="checkbox"/>	<input type="checkbox"/>	102
<input checked="" type="checkbox"/>	<input checked="" type="checkbox"/>	<input type="checkbox"/>	<input type="checkbox"/>	<input type="checkbox"/>	<input type="checkbox"/>	<input type="checkbox"/>	<input type="checkbox"/>	7	<input type="checkbox"/>	<input type="checkbox"/>	<input type="checkbox"/>	<input type="checkbox"/>	<input type="checkbox"/>	<input type="checkbox"/>	<input type="checkbox"/>	<input type="checkbox"/>	<input type="checkbox"/>	39	<input type="checkbox"/>	<input type="checkbox"/>	<input type="checkbox"/>	<input type="checkbox"/>	<input type="checkbox"/>	<input type="checkbox"/>	<input type="checkbox"/>	<input type="checkbox"/>	<input type="checkbox"/>	<input type="checkbox"/>	<input type="checkbox"/>	<input type="checkbox"/>	71	<input type="checkbox"/>	<input type="checkbox"/>	<input type="checkbox"/>	<input type="checkbox"/>	<input type="checkbox"/>	<input type="checkbox"/>	<input type="checkbox"/>	103
<input type="checkbox"/>	<input type="checkbox"/>	<input type="checkbox"/>	<input type="checkbox"/>	<input type="checkbox"/>	<input type="checkbox"/>	<input type="checkbox"/>	<input type="checkbox"/>	8	<input type="checkbox"/>	<input type="checkbox"/>	<input type="checkbox"/>	<input type="checkbox"/>	<input type="checkbox"/>	<input type="checkbox"/>	<input type="checkbox"/>	<input type="checkbox"/>	<input type="checkbox"/>	40	<input type="checkbox"/>	<input type="checkbox"/>	<input type="checkbox"/>	<input type="checkbox"/>	<input type="checkbox"/>	<input type="checkbox"/>	<input type="checkbox"/>	<input type="checkbox"/>	<input type="checkbox"/>	<input type="checkbox"/>	<input type="checkbox"/>	<input type="checkbox"/>	72	<input type="checkbox"/>	<input type="checkbox"/>	<input type="checkbox"/>	<input type="checkbox"/>	<input type="checkbox"/>	<input type="checkbox"/>	<input type="checkbox"/>	104
<input checked="" type="checkbox"/>	<input type="checkbox"/>	<input type="checkbox"/>	<input type="checkbox"/>	<input type="checkbox"/>	<input type="checkbox"/>	<input type="checkbox"/>	<input type="checkbox"/>	9	<input type="checkbox"/>	<input type="checkbox"/>	<input type="checkbox"/>	<input type="checkbox"/>	<input type="checkbox"/>	<input type="checkbox"/>	<input type="checkbox"/>	<input type="checkbox"/>	<input type="checkbox"/>	41	<input type="checkbox"/>	<input type="checkbox"/>	<input type="checkbox"/>	<input type="checkbox"/>	<input type="checkbox"/>	<input type="checkbox"/>	<input type="checkbox"/>	<input type="checkbox"/>	<input type="checkbox"/>	<input type="checkbox"/>	<input type="checkbox"/>	<input type="checkbox"/>	73	<input type="checkbox"/>	<input type="checkbox"/>	<input type="checkbox"/>	<input type="checkbox"/>	<input type="checkbox"/>	<input type="checkbox"/>	<input type="checkbox"/>	105
<input type="checkbox"/>	<input type="checkbox"/>	<input type="checkbox"/>	<input type="checkbox"/>	<input type="checkbox"/>	<input type="checkbox"/>	<input type="checkbox"/>	<input type="checkbox"/>	10	<input type="checkbox"/>	<input type="checkbox"/>	<input type="checkbox"/>	<input type="checkbox"/>	<input type="checkbox"/>	<input type="checkbox"/>	<input type="checkbox"/>	<input type="checkbox"/>	<input type="checkbox"/>	42	<input type="checkbox"/>	<input type="checkbox"/>	<input type="checkbox"/>	<input type="checkbox"/>	<input type="checkbox"/>	<input type="checkbox"/>	<input type="checkbox"/>	<input type="checkbox"/>	<input type="checkbox"/>	<input type="checkbox"/>	<input type="checkbox"/>	<input type="checkbox"/>	74	<input type="checkbox"/>	<input type="checkbox"/>	<input type="checkbox"/>	<input type="checkbox"/>	<input type="checkbox"/>	<input type="checkbox"/>	<input type="checkbox"/>	106
<input checked="" type="checkbox"/>	<input checked="" type="checkbox"/>	<input type="checkbox"/>	<input type="checkbox"/>	<input type="checkbox"/>	<input type="checkbox"/>	<input type="checkbox"/>	<input type="checkbox"/>	11	<input type="checkbox"/>	<input type="checkbox"/>	<input type="checkbox"/>	<input type="checkbox"/>	<input type="checkbox"/>	<input type="checkbox"/>	<input type="checkbox"/>	<input type="checkbox"/>	<input type="checkbox"/>	43	<input type="checkbox"/>	<input type="checkbox"/>	<input type="checkbox"/>	<input type="checkbox"/>	<input type="checkbox"/>	<input type="checkbox"/>	<input type="checkbox"/>	<input type="checkbox"/>	<input type="checkbox"/>	<input type="checkbox"/>	<input type="checkbox"/>	<input type="checkbox"/>	75	<input type="checkbox"/>	<input type="checkbox"/>	<input type="checkbox"/>	<input type="checkbox"/>	<input type="checkbox"/>	<input type="checkbox"/>	<input type="checkbox"/>	107
<input type="checkbox"/>	<input type="checkbox"/>	<input type="checkbox"/>	<input type="checkbox"/>	<input type="checkbox"/>	<input type="checkbox"/>	<input type="checkbox"/>	<input type="checkbox"/>	12	<input type="checkbox"/>	<input type="checkbox"/>	<input type="checkbox"/>	<input type="checkbox"/>	<input type="checkbox"/>	<input type="checkbox"/>	<input type="checkbox"/>	<input type="checkbox"/>	<input type="checkbox"/>	44	<input type="checkbox"/>	<input type="checkbox"/>	<input type="checkbox"/>	<input type="checkbox"/>	<input type="checkbox"/>	<input type="checkbox"/>	<input type="checkbox"/>	<input type="checkbox"/>	<input type="checkbox"/>	<input type="checkbox"/>	<input type="checkbox"/>	<input type="checkbox"/>	76	<input type="checkbox"/>	<input type="checkbox"/>	<input type="checkbox"/>	<input type="checkbox"/>	<input type="checkbox"/>	<input type="checkbox"/>	<input type="checkbox"/>	108
<input checked="" type="checkbox"/>	<input type="checkbox"/>	<input type="checkbox"/>	<input type="checkbox"/>	<input type="checkbox"/>	<input type="checkbox"/>	<input type="checkbox"/>	<input type="checkbox"/>	13	<input type="checkbox"/>	<input type="checkbox"/>	<input type="checkbox"/>	<input type="checkbox"/>	<input type="checkbox"/>	<input type="checkbox"/>	<input type="checkbox"/>	<input type="checkbox"/>	<input type="checkbox"/>	45	<input type="checkbox"/>	<input type="checkbox"/>	<input type="checkbox"/>	<input type="checkbox"/>	<input type="checkbox"/>	<input type="checkbox"/>	<input type="checkbox"/>	<input type="checkbox"/>	<input type="checkbox"/>	<input type="checkbox"/>	<input type="checkbox"/>	<input type="checkbox"/>	77	<input type="checkbox"/>	<input type="checkbox"/>	<input type="checkbox"/>	<input type="checkbox"/>	<input type="checkbox"/>	<input type="checkbox"/>	<input type="checkbox"/>	109
<input type="checkbox"/>	<input type="checkbox"/>	<input type="checkbox"/>	<input type="checkbox"/>	<input type="checkbox"/>	<input type="checkbox"/>	<input type="checkbox"/>	<input type="checkbox"/>	14	<input type="checkbox"/>	<input type="checkbox"/>	<input type="checkbox"/>	<input type="checkbox"/>	<input type="checkbox"/>	<input type="checkbox"/>	<input type="checkbox"/>	<input type="checkbox"/>	<input type="checkbox"/>	46	<input type="checkbox"/>	<input type="checkbox"/>	<input type="checkbox"/>	<input type="checkbox"/>	<input type="checkbox"/>	<input type="checkbox"/>	<input type="checkbox"/>	<input type="checkbox"/>	<input type="checkbox"/>	<input type="checkbox"/>	<input type="checkbox"/>	<input type="checkbox"/>	78	<input type="checkbox"/>	<input type="checkbox"/>	<input type="checkbox"/>	<input type="checkbox"/>	<input type="checkbox"/>	<input type="checkbox"/>	<input type="checkbox"/>	110
<input checked="" type="checkbox"/>	<input checked="" type="checkbox"/>	<input type="checkbox"/>	<input type="checkbox"/>	<input type="checkbox"/>	<input type="checkbox"/>	<input type="checkbox"/>	<input type="checkbox"/>	15	<input type="checkbox"/>	<input type="checkbox"/>	<input type="checkbox"/>	<input type="checkbox"/>	<input type="checkbox"/>	<input type="checkbox"/>	<input type="checkbox"/>	<input type="checkbox"/>	<input type="checkbox"/>	47	<input type="checkbox"/>	<input type="checkbox"/>	<input type="checkbox"/>	<input type="checkbox"/>	<input type="checkbox"/>	<input type="checkbox"/>	<input type="checkbox"/>	<input type="checkbox"/>	<input type="checkbox"/>	<input type="checkbox"/>	<input type="checkbox"/>	<input type="checkbox"/>	79	<input type="checkbox"/>	<input type="checkbox"/>	<input type="checkbox"/>	<input type="checkbox"/>	<input type="checkbox"/>	<input type="checkbox"/>	<input type="checkbox"/>	111
<input type="checkbox"/>	<input type="checkbox"/>	<input type="checkbox"/>	<input type="checkbox"/>	<input type="checkbox"/>	<input type="checkbox"/>	<input type="checkbox"/>	<input type="checkbox"/>	16	<input type="checkbox"/>	<input type="checkbox"/>	<input type="checkbox"/>	<input type="checkbox"/>	<input type="checkbox"/>	<input type="checkbox"/>	<input type="checkbox"/>	<input type="checkbox"/>	<input type="checkbox"/>	48	<input type="checkbox"/>	<input type="checkbox"/>	<input type="checkbox"/>	<input type="checkbox"/>	<input type="checkbox"/>	<input type="checkbox"/>	<input type="checkbox"/>	<input type="checkbox"/>	<input type="checkbox"/>	<input type="checkbox"/>	<input type="checkbox"/>	<input type="checkbox"/>	80	<input type="checkbox"/>	<input type="checkbox"/>	<input type="checkbox"/>	<input type="checkbox"/>	<input type="checkbox"/>	<input type="checkbox"/>	<input type="checkbox"/>	112
<input checked="" type="checkbox"/>	<input type="checkbox"/>	<input type="checkbox"/>	<input type="checkbox"/>	<input type="checkbox"/>	<input type="checkbox"/>	<input type="checkbox"/>	<input type="checkbox"/>	17	<input type="checkbox"/>	<input type="checkbox"/>	<input type="checkbox"/>	<input type="checkbox"/>	<input type="checkbox"/>	<input type="checkbox"/>	<input type="checkbox"/>	<input type="checkbox"/>	<input type="checkbox"/>	49	<input type="checkbox"/>	<input type="checkbox"/>	<input type="checkbox"/>	<input type="checkbox"/>	<input type="checkbox"/>	<input type="checkbox"/>	<input type="checkbox"/>	<input type="checkbox"/>	<input type="checkbox"/>	<input type="checkbox"/>	<input type="checkbox"/>	<input type="checkbox"/>	81	<input type="checkbox"/>	<input type="checkbox"/>	<input type="checkbox"/>	<input type="checkbox"/>	<input type="checkbox"/>	<input type="checkbox"/>	<input type="checkbox"/>	113
<input type="checkbox"/>	<input type="checkbox"/>	<input type="checkbox"/>	<input type="checkbox"/>	<input type="checkbox"/>	<input type="checkbox"/>	<input type="checkbox"/>	<input type="checkbox"/>	18	<input type="checkbox"/>	<input type="checkbox"/>	<input type="checkbox"/>	<input type="checkbox"/>	<input type="checkbox"/>	<input type="checkbox"/>	<input type="checkbox"/>	<input type="checkbox"/>	<input type="checkbox"/>	50	<input type="checkbox"/>	<input type="checkbox"/>	<input type="checkbox"/>	<input type="checkbox"/>	<input type="checkbox"/>	<input type="checkbox"/>	<input type="checkbox"/>	<input type="checkbox"/>	<input type="checkbox"/>	<input type="checkbox"/>	<input type="checkbox"/>	<input type="checkbox"/>	82	<input type="checkbox"/>	<input type="checkbox"/>	<input type="checkbox"/>	<input type="checkbox"/>	<input type="checkbox"/>	<input type="checkbox"/>	<input type="checkbox"/>	114
<input checked="" type="checkbox"/>	<input checked="" type="checkbox"/>	<input type="checkbox"/>	<input type="checkbox"/>	<input type="checkbox"/>	<input type="checkbox"/>	<input type="checkbox"/>	<input type="checkbox"/>	19	<input type="checkbox"/>	<input type="checkbox"/>	<input type="checkbox"/>	<input type="checkbox"/>	<input type="checkbox"/>	<input type="checkbox"/>	<input type="checkbox"/>	<input type="checkbox"/>	<input type="checkbox"/>	51	<input type="checkbox"/>	<input type="checkbox"/>	<input type="checkbox"/>	<input type="checkbox"/>	<input type="checkbox"/>	<input type="checkbox"/>	<input type="checkbox"/>	<input type="checkbox"/>	<input type="checkbox"/>	<input type="checkbox"/>	<input type="checkbox"/>	<input type="checkbox"/>	83	<input type="checkbox"/>	<input type="checkbox"/>	<input type="checkbox"/>	<input type="checkbox"/>	<input type="checkbox"/>	<input type="checkbox"/>	<input type="checkbox"/>	115
<input type="checkbox"/>	<input type="checkbox"/>	<input type="checkbox"/>	<input type="checkbox"/>	<input type="checkbox"/>	<input type="checkbox"/>	<input type="checkbox"/>	<input type="checkbox"/>	20	<input type="checkbox"/>	<input type="checkbox"/>	<input type="checkbox"/>	<input type="checkbox"/>	<input type="checkbox"/>	<input type="checkbox"/>	<input type="checkbox"/>	<input type="checkbox"/>	<input type="checkbox"/>	52	<input type="checkbox"/>	<input type="checkbox"/>	<input type="checkbox"/>	<input type="checkbox"/>	<input type="checkbox"/>	<input type="checkbox"/>	<input type="checkbox"/>	<input type="checkbox"/>	<input type="checkbox"/>	<input type="checkbox"/>	<input type="checkbox"/>	<input type="checkbox"/>	84	<input type="checkbox"/>	<input type="checkbox"/>	<input type="checkbox"/>	<input type="checkbox"/>	<input type="checkbox"/>	<input type="checkbox"/>	<input type="checkbox"/>	116
<input checked="" type="checkbox"/>	<input type="checkbox"/>	<input type="checkbox"/>	<input type="checkbox"/>	<input type="checkbox"/>	<input type="checkbox"/>	<input type="checkbox"/>	<input type="checkbox"/>	21	<input type="checkbox"/>	<input type="checkbox"/>	<input type="checkbox"/>	<input type="checkbox"/>	<input type="checkbox"/>	<input type="checkbox"/>	<input type="checkbox"/>	<input type="checkbox"/>	<input type="checkbox"/>	53	<input type="checkbox"/>	<input type="checkbox"/>	<input type="checkbox"/>	<input type="checkbox"/>	<input type="checkbox"/>	<input type="checkbox"/>	<input type="checkbox"/>	<input type="checkbox"/>	<input type="checkbox"/>	<input type="checkbox"/>	<input type="checkbox"/>	<input type="checkbox"/>	85	<input type="checkbox"/>	<input type="checkbox"/>	<input type="checkbox"/>	<input type="checkbox"/>	<input type="checkbox"/>	<input type="checkbox"/>	<input type="checkbox"/>	117
<input type="checkbox"/>	<input type="checkbox"/>	<input type="checkbox"/>	<input type="checkbox"/>	<input type="checkbox"/>	<input type="checkbox"/>	<input type="checkbox"/>	<input type="checkbox"/>	22	<input type="checkbox"/>	<input type="checkbox"/>	<input type="checkbox"/>	<input type="checkbox"/>	<input type="checkbox"/>	<input type="checkbox"/>	<input type="checkbox"/>	<input type="checkbox"/>	<input type="checkbox"/>	54	<input type="checkbox"/>	<input type="checkbox"/>	<input type="checkbox"/>	<input type="checkbox"/>	<input type="checkbox"/>	<input type="checkbox"/>	<input type="checkbox"/>	<input type="checkbox"/>	<input type="checkbox"/>	<input type="checkbox"/>	<input type="checkbox"/>	<input type="checkbox"/>	86	<input type="checkbox"/>	<input type="checkbox"/>	<input type="checkbox"/>	<input type="checkbox"/>	<input type="checkbox"/>	<input type="checkbox"/>	<input type="checkbox"/>	118
<input checked="" type="checkbox"/>	<input checked="" type="checkbox"/>	<input type="checkbox"/>	<input type="checkbox"/>	<input type="checkbox"/>	<input type="checkbox"/>	<input type="checkbox"/>	<input type="checkbox"/>	23	<input type="checkbox"/>	<input type="checkbox"/>	<input type="checkbox"/>	<input type="checkbox"/>	<input type="checkbox"/>	<input type="checkbox"/>	<input type="checkbox"/>	<input type="checkbox"/>	<input type="checkbox"/>	55	<input type="checkbox"/>	<input type="checkbox"/>	<input type="checkbox"/>	<input type="checkbox"/>	<input type="checkbox"/>	<input type="checkbox"/>	<input type="checkbox"/>	<input type="checkbox"/>	<input type="checkbox"/>	<input type="checkbox"/>	<input type="checkbox"/>	<input type="checkbox"/>	87	<input type="checkbox"/>	<input type="checkbox"/>	<input type="checkbox"/>	<input type="checkbox"/>	<input type="checkbox"/>	<input type="checkbox"/>	<input type="checkbox"/>	119
<input type="checkbox"/>	<input type="checkbox"/>	<input type="checkbox"/>	<input type="checkbox"/>	<input type="checkbox"/>	<input type="checkbox"/>	<input type="checkbox"/>	<input type="checkbox"/>	24	<input type="checkbox"/>	<input type="checkbox"/>	<input type="checkbox"/>	<input type="checkbox"/>	<input type="checkbox"/>	<input type="checkbox"/>	<input type="checkbox"/>	<input type="checkbox"/>	<input type="checkbox"/>	56	<input type="checkbox"/>	<input type="checkbox"/>	<input type="checkbox"/>	<input type="checkbox"/>	<input type="checkbox"/>	<input type="checkbox"/>	<input type="checkbox"/>	<input type="checkbox"/>	<input type="checkbox"/>	<input type="checkbox"/>	<input type="checkbox"/>	<input type="checkbox"/>	88	<input type="checkbox"/>	<input type="checkbox"/>	<input type="checkbox"/>	<input type="checkbox"/>	<input type="checkbox"/>	<input type="checkbox"/>	<input type="checkbox"/>	120
<input checked="" type="checkbox"/>	<input type="checkbox"/>	<input type="checkbox"/>	<input type="checkbox"/>	<input type="checkbox"/>	<input type="checkbox"/>	<input type="checkbox"/>	<input type="checkbox"/>	25	<input type="checkbox"/>	<input type="checkbox"/>	<input type="checkbox"/>	<input type="checkbox"/>	<input type="checkbox"/>	<input type="checkbox"/>	<input type="checkbox"/>	<input type="checkbox"/>	<input type="checkbox"/>	57	<input type="checkbox"/>	<input type="checkbox"/>	<input type="checkbox"/>	<input type="checkbox"/>	<input type="checkbox"/>	<input type="checkbox"/>	<input type="checkbox"/>	<input type="checkbox"/>	<input type="checkbox"/>	<input type="checkbox"/>	<input type="checkbox"/>	<input type="checkbox"/>	89	<input type="checkbox"/>	<input type="checkbox"/>	<input type="checkbox"/>	<input type="checkbox"/>	<input type="checkbox"/>	<input type="checkbox"/>	<input type="checkbox"/>	121
<input type="checkbox"/>	<input type="checkbox"/>	<input type="checkbox"/>	<input type="checkbox"/>	<input type="checkbox"/>	<input type="checkbox"/>	<input type="checkbox"/>	<input type="checkbox"/>	26	<input type="checkbox"/>	<input type="checkbox"/>	<input type="checkbox"/>	<input type="checkbox"/>	<input type="checkbox"/>	<input type="checkbox"/>	<input type="checkbox"/>	<input type="checkbox"/>	<input type="checkbox"/>	58	<input type="checkbox"/>	<input type="checkbox"/>	<input type="checkbox"/>	<input type="checkbox"/>	<input type="checkbox"/>	<input type="checkbox"/>	<input type="checkbox"/>	<input type="checkbox"/>	<input type="checkbox"/>	<input type="checkbox"/>	<input type="checkbox"/>	<input type="checkbox"/>	90	<input type="checkbox"/>	<input type="checkbox"/>	<input type="checkbox"/>	<input type="checkbox"/>	<input type="checkbox"/>	<input type="checkbox"/>	<input type="checkbox"/>	122
<input checked="" type="checkbox"/>	<input checked="" type="checkbox"/>	<input type="checkbox"/>	<input type="checkbox"/>	<input type="checkbox"/>	<input type="checkbox"/>	<input type="checkbox"/>	<input type="checkbox"/>	27	<input type="checkbox"/>	<input type="checkbox"/>	<input type="checkbox"/>	<input type="checkbox"/>	<input type="checkbox"/>	<input type="checkbox"/>	<input type="checkbox"/>	<input type="checkbox"/>	<input type="checkbox"/>	59	<input type="checkbox"/>	<input type="checkbox"/>	<input type="checkbox"/>	<input type="checkbox"/>	<input type="checkbox"/>	<input type="checkbox"/>	<input type="checkbox"/>	<input type="checkbox"/>	<input type="checkbox"/>	<input type="checkbox"/>	<input type="checkbox"/>	<input type="checkbox"/>	91	<input type="checkbox"/>	<input type="checkbox"/>	<input type="checkbox"/>	<input type="checkbox"/>	<input type="checkbox"/>	<input type="checkbox"/>	<input type="checkbox"/>	123
<input type="checkbox"/>	<input type="checkbox"/>	<input type="checkbox"/>	<input type="checkbox"/>	<input type="checkbox"/>	<input type="checkbox"/>	<input type="checkbox"/>	<input type="checkbox"/>	28	<input type="checkbox"/>	<input type="checkbox"/>	<input type="checkbox"/>	<input type="checkbox"/>	<input type="checkbox"/>	<input type="checkbox"/>	<input type="checkbox"/>	<input type="checkbox"/>	<input type="checkbox"/>	60	<input type="checkbox"/>	<input type="checkbox"/>	<input type="checkbox"/>	<input type="checkbox"/>	<input type="checkbox"/>	<input type="checkbox"/>	<input type="checkbox"/>	<input type="checkbox"/>	<input type="checkbox"/>	<input type="checkbox"/>	<input type="checkbox"/>	<input type="checkbox"/>	92	<input type="checkbox"/>	<input type="checkbox"/>	<input type="checkbox"/>	<input type="checkbox"/>	<input type="checkbox"/>	<input type="checkbox"/>	<input type="checkbox"/>	124
<input checked="" type="checkbox"/>	<input type="checkbox"/>	<input type="checkbox"/>	<input type="checkbox"/>	<input type="checkbox"/>	<input type="checkbox"/>	<input type="checkbox"/>	<input type="checkbox"/>	29	<input type="checkbox"/>	<input type="checkbox"/>	<input type="checkbox"/>	<input type="checkbox"/>	<input type="checkbox"/>	<input type="checkbox"/>	<input type="checkbox"/>	<input type="checkbox"/>	<input type="checkbox"/>	61	<input type="checkbox"/>	<input type="checkbox"/>	<input type="checkbox"/>	<input type="checkbox"/>	<input type="checkbox"/>	<input type="checkbox"/>	<input type="checkbox"/>	<input type="checkbox"/>	<input type="checkbox"/>	<input type="checkbox"/>	<input type="checkbox"/>	<input type="checkbox"/>	93	<input type="checkbox"/>	<input type="checkbox"/>	<input type="checkbox"/>	<input type="checkbox"/>	<input type="checkbox"/>	<input type="checkbox"/>	<input type="checkbox"/>	125
<input type="checkbox"/>	<input type="checkbox"/>	<input type="checkbox"/>	<input type="checkbox"/>	<input type="checkbox"/>	<input type="checkbox"/>	<input type="checkbox"/>	<input type="checkbox"/>	30	<input type="checkbox"/>	<input type="checkbox"/>	<input type="checkbox"/>	<input type="checkbox"/>	<input type="checkbox"/>	<input type="checkbox"/>	<input type="checkbox"/>	<input type="checkbox"/>	<input type="checkbox"/>	62	<input type="checkbox"/>	<input type="checkbox"/>	<input type="checkbox"/>	<input type="checkbox"/>	<input type="checkbox"/>	<input type="checkbox"/>	<input type="checkbox"/>	<input type="checkbox"/>	<input type="checkbox"/>	<input type="checkbox"/>	<input type="checkbox"/>	<input type="checkbox"/>	94	<input type="checkbox"/>	<input type="checkbox"/>	<input type="checkbox"/>	<input type="checkbox"/>	<input type="checkbox"/>	<input type="checkbox"/>	<input type="checkbox"/>	126
<input checked="" type="checkbox"/>	<input checked="" type="checkbox"/>	<input type="checkbox"/>	<input type="checkbox"/>	<input type="checkbox"/>	<input type="checkbox"/>	<input type="checkbox"/>	<input type="checkbox"/>	31	<input type="checkbox"/>	<input type="checkbox"/>	<input type="checkbox"/>	<input type="checkbox"/>	<input type="checkbox"/>	<input type="checkbox"/>	<input type="checkbox"/>	<input type="checkbox"/>	<input type="checkbox"/>	63	<input type="checkbox"/>	<input type="checkbox"/>	<input type="checkbox"/>	<input type="checkbox"/>	<input type="checkbox"/>	<input type="checkbox"/>	<input type="checkbox"/>	<input type="checkbox"/>	<input type="checkbox"/>	<input type="checkbox"/>	<input type="checkbox"/>	<input type="checkbox"/>	95	<input type="checkbox"/>	<input type="checkbox"/>	<input type="checkbox"/>	<input type="checkbox"/>	<input type="checkbox"/>	<input type="checkbox"/>	<input type="checkbox"/>	127

Figure 5-15 SLC Device Addressing Using Dipswitches

Section 6

Programming Overview

This section of the manual is intended to give you an overview of the programming process. Please read this section of the manual carefully, especially if you are programming the control panel for the first time.

The JumpStart feature automates many programming tasks and selects default options for the system. You will run JumpStart at least once when you are installing the system. See Section 6.1 for details. After you run JumpStart, you may need to do some additional programming depending on your installation. Section 7 of this manual cover manual programmable options in detail.

Programming the panel can be thought of as a three part process. You must program:

- System options. These are options that affect general operation of the panel (see Section 7.5 for details).
- Options for input points and zones. These are primarily options that control detection behavior of devices (see Section 7.4 for details).
- Options for output points and groups. This includes selecting characteristics for output groups and mapping output circuits to output groups (see Section 7.4 for details).

6.1 JumpStart Autoprogramming

The JumpStart feature allows for faster system setup. When you run JumpStart (immediately after addressing SLC devices), the system scans devices on all SLC loops and determines device type (for example, ionization smoke detector or heat sensor) and selects some system options based on the device type. This saves the installer from having to program options for each device. Depending on the application, the installer may need to make some changes after JumpStart completes.

See Section 6.1.3 for complete details about running JumpStart.

IMPORTANT

JumpStart is intended to be run one time only, immediately after SLC devices have been addressed and connected. JumpStart will reset manually all programmed options to default settings. Do not run JumpStart after you have configured the system.

6.1.1 Input Points

JumpStart will determine the number and type of input points (detectors or contact monitor modules) on each SLC loop. JumpStart assigns the correct detector type (heat, ionization or photoelectric), so the installer does not need to edit device type for detectors. Any contact monitor modules on the system will be assigned type "Manual Pull." The installer will need to manually change the switch type if manual pull is not correct.

JumpStart creates one zone (Zone 1) and assigns all input points to Zone 1. Zone 1 is mapped to Output Group 1. After JumpStart completes, you can re-map to configure a multiple zone/output group system (see Section 7.2.1.3). For a general explanation of mapping, see Section 6.2.

6.1.2 Output Points

JumpStart creates three output groups and assigns output circuits as follows:

Circuits 1-6:

Configured as Notification and assigned to Group 1. JumpStart automatically programs Zone 1 to activate Group 1 using constant on output.

Circuit 7 (Relay 1):

Assigned to Group 249. JumpStart automatically programs Zone 1 to activate Group 249 using constant on output when a supervisory condition occurs.

Circuit 8 (Relay 2):

Assigned to Group 250. JumpStart automatically programs Zone 1 to activate Group 250 using constant on output when an alarm occurs.

Addressable output points (Relay modules):

All addressable relay devices will be configured as "Output Pt" (general purpose output point) and assigned to Group 1.


Note: Relay output is constant even if the zone activating the relay is programmed with an output pattern.

6.1.3 Running JumpStart

Run JumpStart immediately after you have addressed and connected all input devices (detectors, pull stations, and so on) and output devices (notification appliances, relays, and so on).

Note: If you need to install a few devices after you have run JumpStart, you can install them manually. Follow instructions in Section 8 for configuration.

To run JumpStart, follow these steps.

1. You must be in the Installer Menu to run JumpStart. If you are not, enter the Installer Code.
2. Press  to enable the keypad.

3. Select **7** for Program Menu.
4. From the next menu, select **6** for JumpStart.
5. The message "WARNING Will reset all system options" displays on the LCD. Select Yes to continue. A series of messages displays for the next several seconds. JumpStart scans the SLC loops for devices. This can take several minutes, depending on the number of devices attached.
6. When the message "Configure System Done" displays on the LCD, press any key to continue.
7. Select one of the following options from the menu that displays.

1 - Review System	Press 1 if you need to review the JumpStart configuration.
2 - Repeat JumpStart	Press 2 if you need to rerun JumpStart for any reason.
3 - Accept Configuration	<ol style="list-style-type: none"> 1. If you are ready to make the JumpStart configuration permanent, select 3. 2. The system will ask you if the installation contains duct detectors. If there are none, select 2 for No and skip to Step 8. If the system contains duct detectors, select 1 for Yes and continue with Step 3. 3. From the list that displays, select the 5815XL device that contains the duct detectors. 4. The first photoelectric or ionization detector on the system will display. Select 1 for DUCT and 2 for NonDUCT. 5. Press ▲ to select the next detector. Select 1 for DUCT and 2 for NonDUCT. Continue until all duct detectors have been selected. (Note: You can move backwards through the list with ▼.) 6. When you reach the last detector on this device, press ◀. 7. The system will ask you if there are more duct detectors in the system. If there are, select 1 for Yes and repeat from Step 3. If there are no more duct detectors, select 2 for No and continue with Step 8. 8. The system will restart in 10 seconds. You can press 1 to restart immediately. Do not select 2 for System Diagnostics. (This feature is for use in testing at the factory.) 9. After the system resets, it will use the new JumpStart configuration.

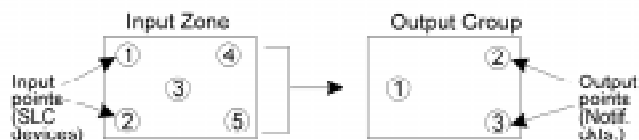
6.2 Mapping Overview

This section of the manual is an overview of mapping. Details about how to select mapping options appear in the appropriate subsections in Section 7.

Mapping is an important concept with the control panel. In general terms, mapping is assigning or linking events to outputs that should activate when events occur. You do this by assigning input points to input zones, output points to output groups and then linking or mapping zones and output groups.

Figure 6-1 is a brief overview of the concept of mapping. The next several pages of the manual show these subjects in detail.

In its simplest application, mapping is determining which outputs are activated by which inputs.



Because the Control Panel programming is so flexible, there are a number of uses for mapping, as shown in the diagram below.

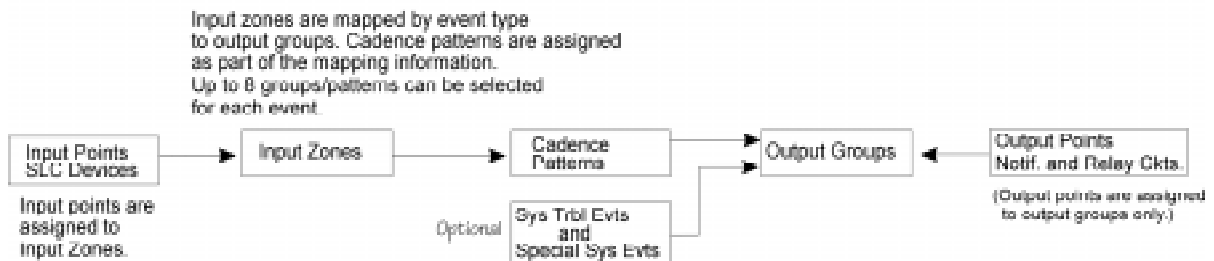


Figure 6-1 Mapping Overview

6.2.1 Input Point Mapping

Input points are assigned to input zones. Any input point can be assigned to any input zone. (Input points can be assigned to one zone only. An input point can be designated as "Unused," which means it has not been assigned to a zone.)

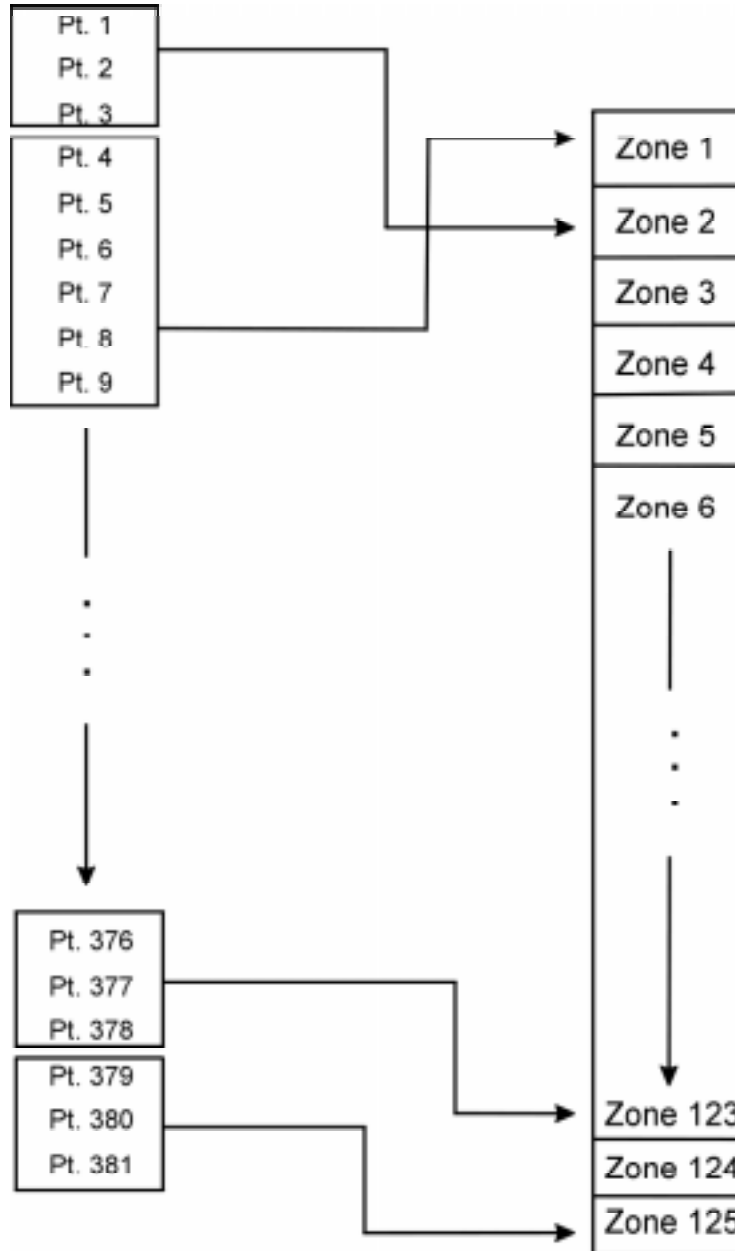


Figure 6-2 Input Point Assignment Example

6.2.2 Output Circuit Mapping

Figure 6-3 is a simple example showing how to assign notification and relay output circuits to groups. For an example of a simple floor above/floor below application, see Figure 6-5.

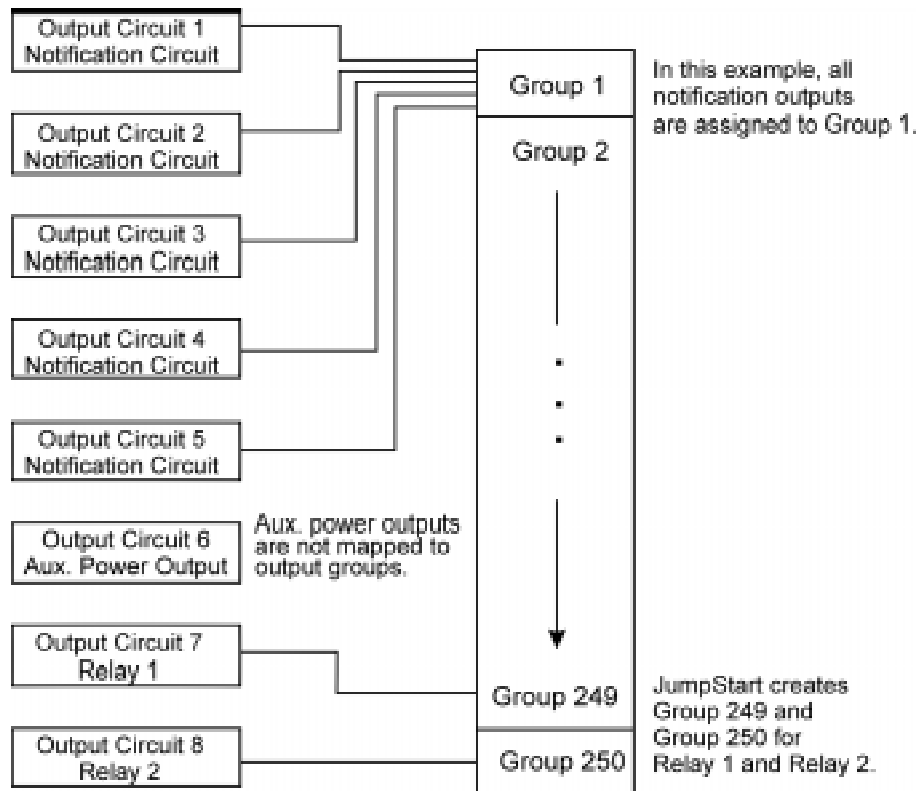


Figure 6-3 Assigning Output Circuits to Groups (Example)

6.2.3 Zone Event Mapping

There are 8 types of events that can occur in zones (see below). For each event type, you can activate up to 8 output groups and patterns. If it is necessary to map to more than 8 output groups, an output group template may be used (see Section 7.3.5 for information on output group templates). Event types are:

- Manual Pull Alarm
- Water Flow Alarm
- Detector Alarm (heat or smoke detectors)
- Aux 1 and Aux 2 Alarm (user-specified alarm types)
- Pre-alarm
- Supervisory
- Trouble

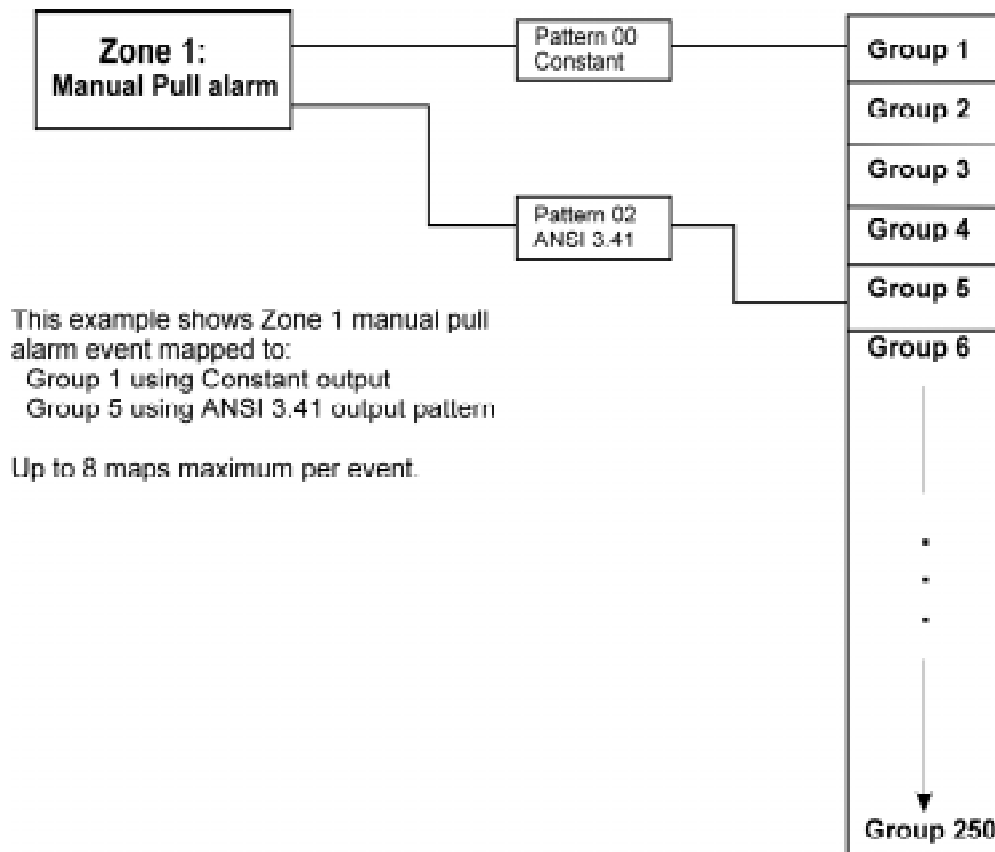


Figure 6-4 Example of Zone Events Mapped to Output Groups and Patterns

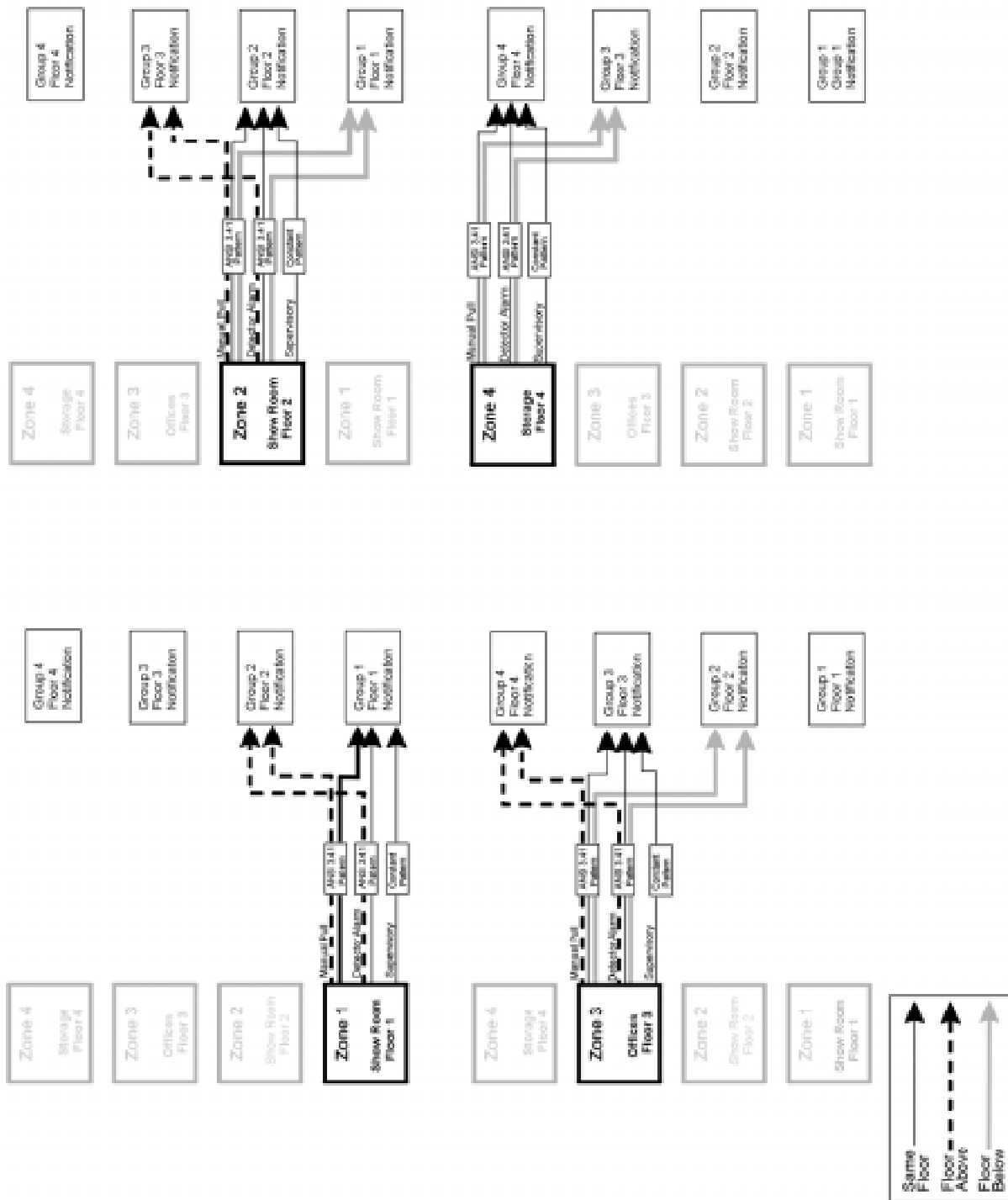


Figure 6-5 Example of Zone Events Mapped to Output Groups and Patterns

6.2.4 Mapping LED Points

Figure 6-6 is a simple example showing how LED points are mapped to zones and output groups. Typically you would create two output groups for each zone, one for alarms and one for troubles. (LED points are available when Models 5865-3/4 and/or 5880 are used with the system.)

Mapping LEDs to Zones and Output Groups

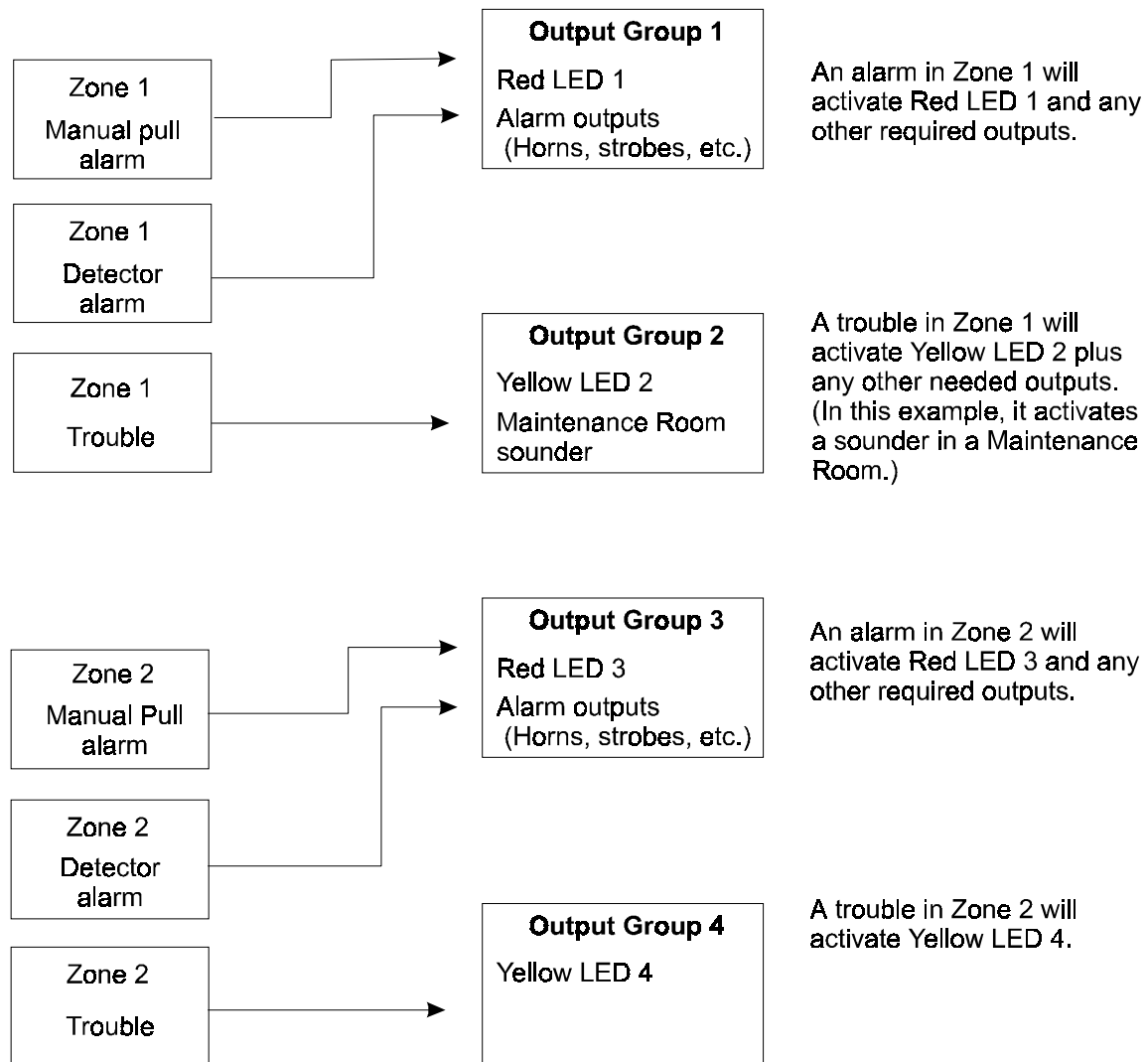


Figure 6-6 Example of LED Points Mapped to Output Groups (applies to Models 5865-3/4 and 5880)

6.3 SK Analog Fire System Editor 5590

There are two ways to program the control panel. One way is to program directly from an annunciator, either the on-board annunciator or a Model 5860 Remote Annunciator. Annunciator programming is explained in Section 6.4.

The other method for programming is through the SK Analog Fire System Editor 5590. The 5590 is an optional software package that allows you to easily program the control panel using a Windows-based computer and a *modem (not sold by Silent Knight). The software works in the following way. First you use the software to program options for the panel, saving the options in a file. You can then download the file to the panel. The software includes an on-line help system and a manual. See the manual (P/N 151004) for more information.

* See Section 1.3 for a list of modems that have been tested for compatibility with the control panel and the SK Analog Fire System Editor 5590.

6.4 Annunciator Programming



There are two ways to program a control panel. One way is through the SK Analog Fire System Editor 5590 (see Section 6.3).

The other method is to program directly from an annunciator, using either the on-board annunciator or a Model 5860 Remote Annunciator.

The following subsections describe programming basics, including a description of editing keys available for programming and how to move through programming menus. Section 7 contain specific information about individual programming options.

6.4.1 Entering / Exiting the Program Menu

To enter the Program Mode:

1. Enter the Installer Code (factory programmed default code is 5820).
2. The display prompts you to press the  or  key to bring up the Installer Main Menu (see Figure 6-7).

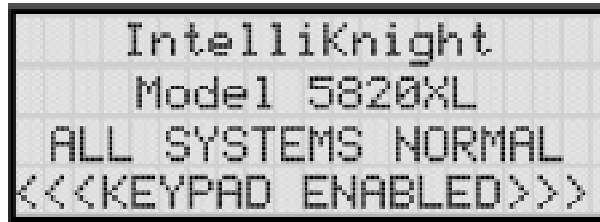




Figure 6-7 Keypad Enabled Screen

3. Then press . The menus described in Section 7 of this manual will display. Section 6.5 of this manual is a quick reference listing all programmable options and JumpStart defaults.

To Exit Program Mode:

When you have completed working with the menus, press  (left arrow) several times until you are exited from programming mode. Two prompts will display. The first prompt is to make sure you intended to leave the Program Menu (select Yes or No as appropriate). The second prompt is for accepting all changes. If you select No, any changes you have made since you entered the Program Menu will have no effect.

6.4.2 Moving through the Menu

Figure 6-8 shows how to move through Program Menu screens, using the System Options screen as an example.

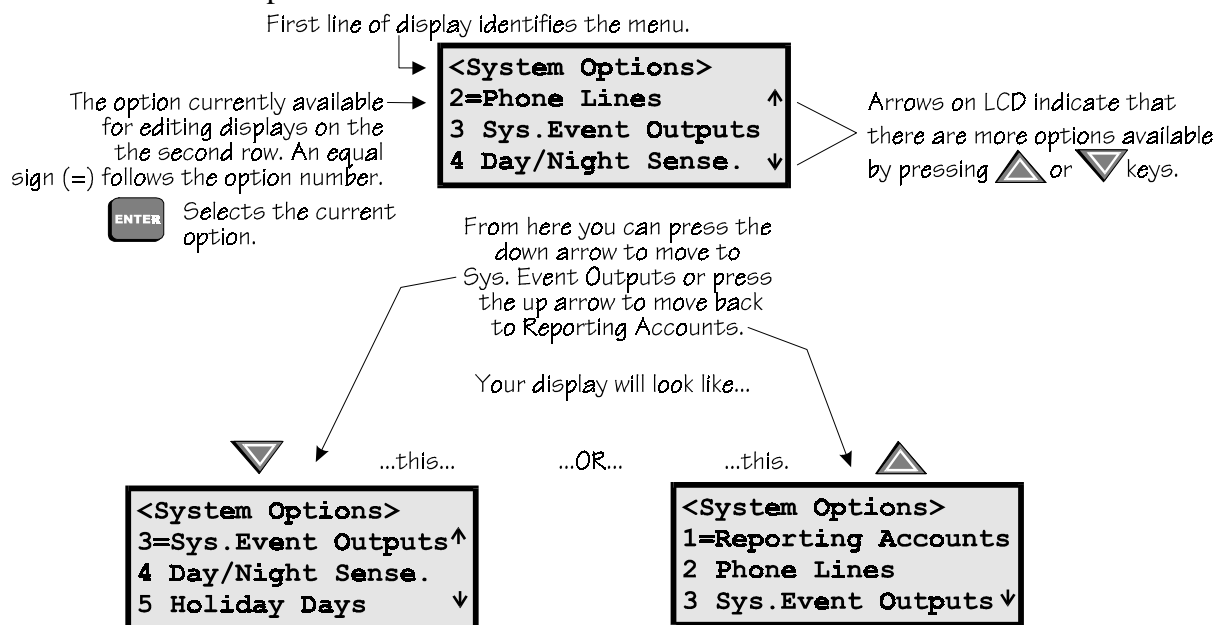


Figure 6-8 Moving through Program Menu (System Options Sub-Menu Used as an Example)

6.4.3 Selecting Options and Entering Data

There are several ways to make programming selections using the control panel depending on which screen you are currently using. The chart below is a generic explanation.

To	Press
Select from a menu.	Enter the number of the option.
Enter numeric data.	Press the appropriate number on the annunciator.
Enter text (alphanumeric data).	Enter each letter individually by pressing and holding any numeric key until the one you wish to select displays. Then press (right arrow) to select the letter. See Section 6.4 for complete information.
Select from a scrolling list.	Use (up arrow) and (down arrow) to move through a list of available options. When the option you want to select is displayed, press .

6.4.4 Editing Keys

The keys shown in Figure 6-9 are available for use when you are in the Program Menu.

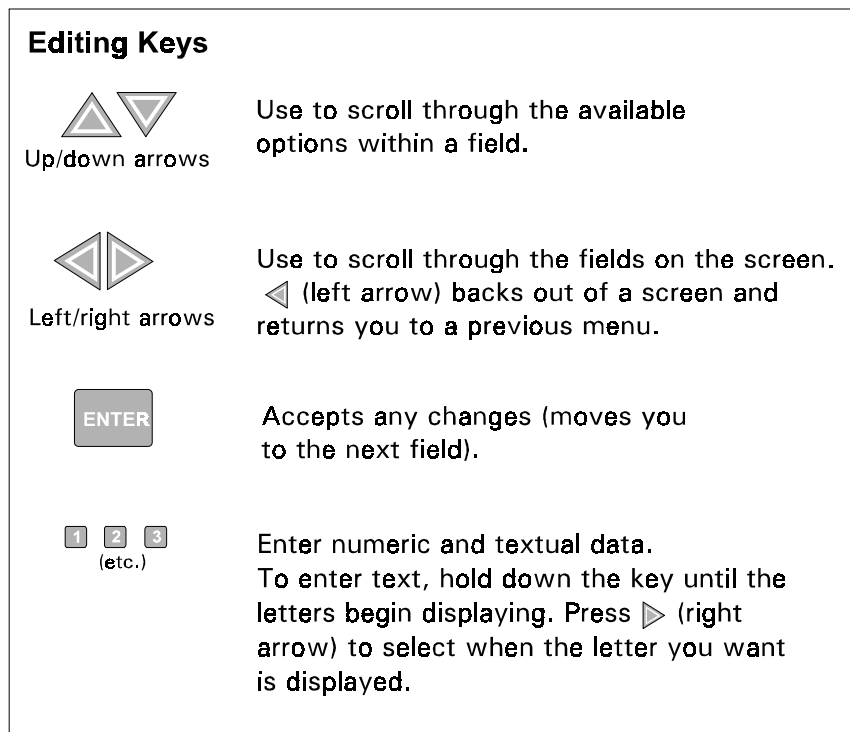


Figure 6-9 Editing Keys Available from Program Menu

6.5 Programming Menu Quick Reference

This section of the manual lists all Program Menu options in the order they appear on the sub-menus. Default settings are indicated in text or marked with an asterisk. The comments column provide quick information and a reference to a section (if applicable) which has more detailed information.

Menu	Options/Defaults				Comments
Module	Edit Module	Internal 5815	Enter Module Name	Select Class	See Section 4.10
		Internal Pwr	Enter Module Name	Select Class	
		Internal Annu	Enter Module Name		
		5897	Enter Module Name		
		5865	Enter Module Name		
		5880	Enter Module Name		
		5824	Enter Module Name		
		5860	Enter Module Name		
		5815XL	Enter Module Name		
	Add Module	5815XL-SLC			See Section 7.1.2
		5860-Keystation			
		5824-Ser/Par/IO			
		5895XL-io/Pwr Sup			
		5880-LED/IO Dev			
		5865-LED Annunc			
Delete Module	List of Modules			See Section 7.1.3	
View Module List	List of Modules				

Menu	Options/Defaults				Comments	
Zone	Edit Zone	Select Zone to Edit	Edit Zone Name	Enter Name1		
				Enter Number1		
				Enter Name2		
				Enter Number2		
			Zone Properties	Verification Type	*1 Count	
					2 Count	
					Alarm Ver.	
					PAS	
				Heat Sensitivity	135° to 150°F	
				Smoke Sensitivity	*Low	3.5% obscurity Sec 7.2.1.2
					Medium	2.5 obscurity Sec 7.2.1.2
			High		1.5% obscurity Sec 7.2.1.2	
			Zone Outputs	Manual Pull (MP)	(Groups 01 & 250, Pattern 00)	Sec. 7.2
				Water Flow (WF)		
				Detector Alarm		
				Aux 1	no group	
	Aux 2					
	Pre-alarm (PRE)					
	Supervisory (SUP)	(Group 249, Pattern 00)				
	Trouble (TRB)	no group				
Add Zone	Adds next available zone number.			Sec. 7.2.2		
Delete Zone	Select Zone to be Deleted			Sec. 7.2.3		
View Zone Points	List of all points in selected zone.			Sec. 7.2.4		

Menu	Options/Defaults				Comments		
Group	Edit Group	Select Group	Group Name	Enter Name1	See Section 7.3.1.1.	Sec. 7.3.1.1	
				Enter Number1			
				Enter Name2			
				Enter Number2			
			Group Properties		Latching Options	*Non-Latching	
						Latching	
					Silencing Options	*SILENCE	Silenceable
						NON-SIL	Non-Silenceable Sec. 7.3.1
						Auto Unsilence	Auto Un-silenced Sec. 7.3.1
						SIL-INHIB	Silence after inhib delay. Sec. 7.3.1
	SHUT-DOWN	Automatic Shutdown Sec. 7.3.1					
	Group Active With:				Group Activates for all Man. Pull	*No	
					Group Activates for Fire Drill	*Yes	
					Group Activates for Aux 1	*No	
			Group Activates for Aux 2	*No			
Ignore Global Cadence			*No				
Add Group							
Delete Group	Select Group to Delete				Sec. 7.3.3		
View Group Points	Select Group						
Edit OPG Template	Select Template Number	Select Group					
		Include in template	Yes				
			No				
Select Pattern	0-16		0 = Constant. Refer to Figure 7-5				

Menu	Options/Defaults			Comments		
Point	Internal and External 5815XL	Enter Pt	UNUSED			
			DETECTOR	PHOTO	Select zone	See Section 7.4.
				ION		
				HEAT		
				PHOT DUCT		
				ION DUCT		
			SWITCH	MAN_PULL		See Section 7.4.
				WATERFLOW	LATCH	
					NLATCH	
				SUPERVSY	LATCH	
					NLATCH	
				FIREDRILL		
				SILENCE		
				RESET		
				PAS_ACK		
				ZN_AUX1	LATCH	
					NLATCH	
				ZN_AUX2	LATCH	
					NLATCH	
			SYS_AUX1	LATCH		
				NLATCH		
			SYS_AUX2	LATCH		
				NLATCH		
			DETECT SW			
			TAMPER			
			NOTIF	OUTPUT PT	Select Group	See Section 7.4.
				AUX CONST		
				AUX RESET		
AUX DOOR						
RELAY	OUTPUT PT	Select Group	See Section 7.4.			
	AUX CONST					
	AUX RESET					
	AUX DOOR					

Menu	Options/Defaults				Comments		
Point (Cont.)	Internal Pwr and External Power	Enter Pt	Input Point Type (detector/switch)	Select Function		Per JumpStart	
		Select Type	UNUSED				
			B NOTIF	Select Group			
			A NOTIF				
			AUX PWR	CONSTANT			
				RESETABLE			
				DOOR			
			B SWITCH	MAN PULL	Select zone	Latch and Non-latch feature only appears for waterflow, supervisory, tamper, zone aux1, zone aux2, system aux1, and system aux2.	
				WATERFLOW	Select zone		
				SUPERVSY	Select zone		
				TAMPER	Select zone		
				FIREDRILL			
				SILENCE			
				RESET			
				PAS_ACK	Select zone		
				ZN_AUX1	Select zone		
			ZN_AUX2	Select zone			
			SYS_AUX1				
			SYS_AUX2				
		A SWITCH	Same as B SWITCH				
	B DETECTOR	2-WIRE SMK					
		4-WIRE SMK					
	A DETECTOR	2-WIRE SMK					
		4-WIRE SMK					
	Select Group or Zone Number				Group or Zone selection will appear depending on the type is selected		
	Edit Name	Enter Name1	See Section 7.4				
		Enter Number1					
		Enter Name2					
Enter Number2							
5880	Enter Point #	NOTIF					
		UNUSED					
	Select Group #						
	Edit Name	Enter Name1					
		Enter Number1					
		Enter Name2					
Enter Number2							
5865	Enter Point #	NOTIF					
		UNUSED					
	Select Group #						
	Edit Name	Enter Name1		See 7.4			
		Enter Number1					
		Enter Name2					
Enter Number2							

Menu	Options/Defaults			Comments		
System Options	Reporting Accounts	Edit Acct.	For each account (1-4), select:			
			Edit Account #		*123456	Account # (6-digit number, identifies account to central station) Sec. 7.5.1
			Edit Format		*Contact ID	Reporting Format (SIA, S20, Contact ID) Sec. 7.5.1
			Report Alarms	Y (Yes)	*No	Sec. 7.5.1
				N (No)		
				M (Must)		
			Rep. Alarm Restore	Y (Yes)		
				N (No)		
				M (Must)		
			Report Troubles	Y (Yes)		
				N (No)		
				M (Must)		
			Report Ena/Disable	Y (Yes)		
				N (No)		
				M (Must)		
			Report Test	Y (Yes)		
				N (No)		
		M (Must)				
		Report Resets	Y (Yes)			
			N (No)			
M (Must)						
Switch attempts	1 - 15	*5	Sec. 7.5.2			
Fail attempts	1 - 15	*10	Sec. 7.5.2			
Primary Phone Line	1 or 2	*Line 1	Sec. 7.5.2			
Secondary Phone Line	1 or 2	*Line 2	Sec. 7.5.2			
Edit Phone #1	up to 40 digits	blank	Sec. 7.5.2			
Auto Test Time	Set the Hour		*02:00 AM	Sec. 7.5.1.2		
	Set the Minutes					
	Select AM/PM					

Menu	Options/Defaults			Comments		
System Option (cont.)	Phone Lines	Select Phone Line	For each phone line (1 & 2), select:			
			Dialing Prefix	Up to 9 digits	none	Sec. 7.5.2.1
			# of Answer Rings	Range: 00-15	06	Number of rings before panel answers a call from a computer Sec. 7.5.2.2
			Select Dialing Option	TT	TouchTone	Touch Tone
				TT/PL		TouchTone alternating with pulse see Section 7.5.2.3
				PULSE		Pulse dialing
			Rotary Pulse Format	U = 60/40	*U	Sec. 7.5.2.4
				E = 66/34		
			Line Monitor	Yes	*No	Sec. 7.5.2.5
				No		
			Enable Ground Start	Yes = enabled	*N = Disabled	Sec. 7.5.2.6
				No = disabled		
			Answering Machine Bypass	Yes = enabled	*Y = Enabled	Sec. 7.5.2.7
				No = disabled		
	System Event Outputs	Trouble Events	System Trouble	Select Group	None selected	Sec. 7.5.3.1
				Select Cadence	None selected	Sec. 7.5.3.1
			Alarm Silence	Select Group	None selected	
				Select Cadence	None selected	
			Trbl Silence	Select Group	None selected	
				Select Cadence	None selected	
			User Selected	Group Tr	Select Group	
				SBUS Com		
				SBUS Pwr		
				SLC Loop		
				AC Loss		
				Battery		
			Sys Alarm Cadence	Gnd Flt	Select Cadence	
				Phone Ln		
Account						
Printer						
Aux Pwr						
Sys Sw						
Fire Drill	Select Cadence	Constant				
System Aux1			Sec.7.5.3.2			
System Aux2						

Menu	Options/Defaults				Comments
System Option (cont.)	Day/Night Sensitivity	Enable Day/Night Sensitivity	Y (Enabled)	*Disabled	Sec.7.5.4
			N (Disabled)		
		Day Start	Select Hour	*06:00 AM	Select Time Day Begins
			Select Minutes		
	Select AM/PM				
	Night Start	Select Hour	*06:00 PM	Select Time Night Begins	
		Select Minutes			
		Select AM/PM			
	Holiday Days	Holidays 1 to 9	*Jan 1, July 4, Dec 24, Dec 25	Select Days of Week for Day/ Night Sensitivity	
		Holidays 10 to 18	None		
	Misc. Options	Water Flow Delay	0 - 90 Seconds	*30 sec	Water Flow delay is the number of sec before water flow alarm is generated. Sec. 7.5.6.1
		Low AC Delay	6 - 30 hours	*6 hrs	Low AC Report Delay. Sec. 7.5.6.2
		DST	Y (Enabled)	*Enabled	Automatic daylight Savings enable or disable. Sec. 7.5.6.3
			N (Disabled)		
		CLK	AM/PM	*AM/PM	System Clock Format (AM/PM or military). Sec. 7.5.6.4
			MIL		
	AC Freq:	50 Hz			
		60 Hz			
		Neither			
	Edit Library Name	Select Word Number	120 to 255		This option is for adding words to the library. Sec. 7.5.7
Edit Word				This option is for changing the normal mode display on the system LCD. See Sec. 7.5.7	
Edit Banner	Internal Message			See Section 7.5.8	
	Custom Message	Edit Line 1			
		Edit Line 2			
JumpStart AutoPrg	No			See Section 7.6	
	Yes				
Computer Account	Computer Account #	*5820		See also Section 7.7	
	Computer Access Code	*0			
	Computer Phone #	Up to 40 digits			
Access Codes	User Code	*1111	4 to 7 digits	See Section 8.4.11.	
	Installer Code	*5820			

Section 7

Programming

This section of the manual manually program the control panel. Each subsection discusses these menu options in detail. All options described in this section can be performed using the SK Analog Fire System Editor 5590.

Important!

Before any customized programming is done, JumpStart should be run first. After JumpStart is run, thoroughly test the system. The reason the system should be tested after JumpStart is because Jumpstart automatically programs the system, searching for and configuring all SLC and SBUS devices it finds. JumpStart allows you to confirm the integrity of the installation prior to performing any custom programming. After determining that the hardware is properly installed, custom programming can be performed. Refer to Section 6.




7.1 Modules

This section lists the options available under the module option in the program menu. The types of modules available for the control panel are, 5815XL (SLC), 5860 (Keystation), 5824 (Serial/Parallel input/output), 5895XL (Input/output Power Supply), 5880 (LED Input/Output module), and a 5865 (LED Annunciator).





7.1.1 Edit Modules

The features that can be edited when this option is selected are, module name, and class of wiring (Class A or Class B).

To edit an existing module, follow these steps:

1. Enter the installer code.
2. Press  or  to display the installer menu.
3. Select  for Program Menu.

```
Display reads:      Initializing
                   Please wait . . .
```

4. Press  to enter module menu.
5. Press  to edit a module.
6. Use the  or  arrow to select the module you wish to edit.

- From the next screen, select the number that corresponds to the type of module you are adding from the <New Module Type> screen.

The screen will display “Adding module [#]...” for a few moments. You will be returned to the <Module Programming> screen where you can select a name for the module if desired (see Section 7.1.1.1).




You must save changes when you exit the Program Menu or the new module will not be added.

Note: If you Add a Module that has not been physically connected, the panel will go into trouble after it reinitializes (when you exit the Program Menu). When the new module is attached, the trouble will correct itself automatically the next time you power up the system.



7.1.3 Deleting a Module

If you ever need to delete a module, follow these steps.

You must be in the Installer Menu to perform this task. If necessary, enter the Installer Code.

- Enter the installer code.
- Press  or  to display the installer menu.
- Select  for Program Menu.

```
Display reads:      Initializing
                   Please wait . . .
```

- Press  to enter module menu.
- Press  to delete a module.
- A warning screen will display. If you want to proceed with deleting the module, select Yes. To cancel, select No.




7.2 Zone

Through the zone option in the program menu you can edit, add, delete, and view zone points. Selections made here affect all detectors and switches in the zone. Up to 125 zones can be used in the system.




7.2.1 Edit Zone

Features that can be edited through the edit zone option are, edit zone name, zone properties (which includes, zone type, and detector sensitivity), and zone output mapping.

To edit a zone, follow these steps:

1. Enter the installer code.
2. Press  or  to display the installer menu.
3. Select  for Program Menu.

```
Display reads:      Initializing
                   Please wait . . .
```

4. Press  to enter zone menu.
5. Press  to edit a zone.
6. Enter the zone number, then press .

7.2.1.1 Edit Zone Name

- Press **1** to edit the selected zone's name.

A screen similar to the one shown in Figure 7-2 displays. Select a one- or two-word descriptive name as shown in the diagram.

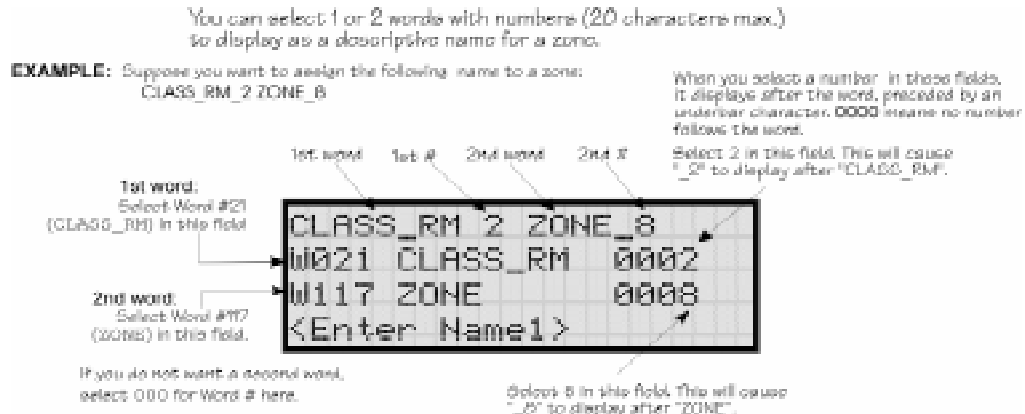


Figure 7-2 Selecting a Name for a Zone

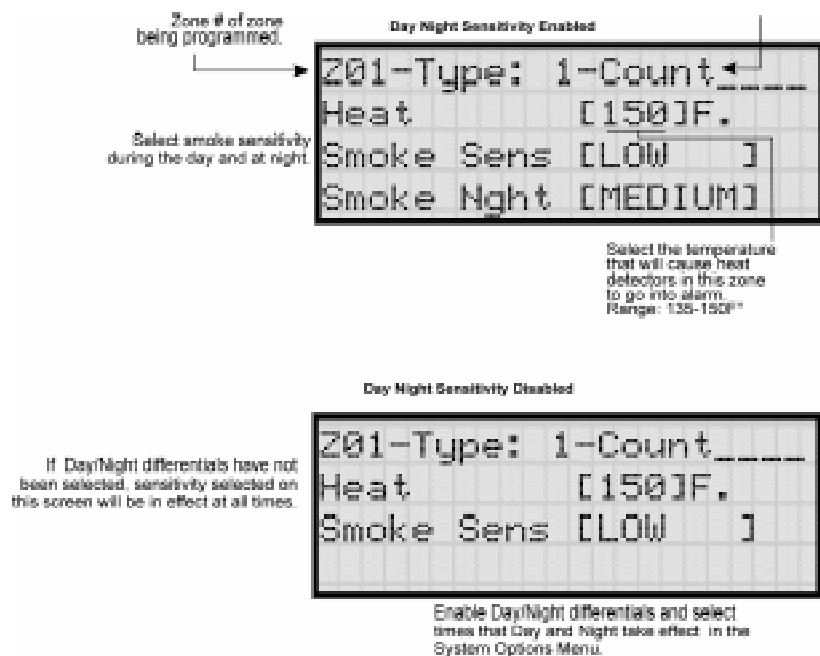
See Appendix B Table B-1 of this manual for a list of available words. If you want to use a word not in the list, you can add the word to the "library" (or list) of words that is available to be used with the control panel.

7.2.1.2 Edit Zone Properties

Zone properties consist of, alarm delay characteristics, heat detector sensitivity, and smoke detector sensitivity.

- Do steps 1 through 6 of Section 7.2.1.
- Press **2** to edit the properties of the selected zone.

Detection type also selected from this screen (see Table 7-1).



Alarm Delay Characteristics

- Select the alarm delay characteristics by pressing the  or  arrow.

Table 7-1 list the delay choices and a description of each.

Table 7-1: Alarm Delay Characteristics

Type of Delay	Description
1-Count	One Count (No Delay). When this option is enabled, an alarm occurs immediately when a single device of any of the following types goes into alarm: detector, manual pull, water flow, Aux1 or Aux2. This is considered the most typical operation and is the default for all zones.
2-Count	<p>When this type of alarm delay is used, two or more detectors within the zone must go into alarm in order for the zone to report an alarm. Switches of type manual pull, water flow, Aux1 and Aux2 are an exception; they will cause an alarm when only one switch is in alarm.</p> <p>When a single detector is in alarm in a 2-Count zone, the system enters a prealarm condition. In a prealarm condition, the touchpad PZT beeps and the annunciator display indicates that a prealarm has occurred. If the zone has been mapped to an output group for the prealarm event, the output group will activate. The prealarm will not be reported to the central station.</p>
Alarm Ver.	Alarm verification is an optional false alarm prevention feature that verifies an alarm condition by resetting the smoke detector. If the alarm condition still exists by the time the reset cycle has completed, the detector will go into alarm. If the detector is no longer in alarm, no report will go to the central station. The alarm verification sequence is ignored if the zone is already in alarm.
PAS	<p>This option is intended to be used with an acknowledge switch. An alarm is delayed for 15 seconds, giving on-site personnel a chance to investigate the alarm. If the acknowledge switch is not activated within 15 seconds, an alarm occurs automatically.</p> <p>If this option is enabled for a zone, the zone will respond to an alarm condition as follows:</p> <ul style="list-style-type: none"> • The zone will not go into alarm for 15 seconds to allow an on-site operator to activate the acknowledge switch. • If the operator does not press the acknowledge switch within 15 seconds, the zone will go into alarm. • If the operator presses the acknowledge switch within 15 seconds, a 180-second time-frame will begin counting down. This time-frame allows the operator to investigate the cause of the alarm. <p>If the operator performs a reset within 180 seconds, the alarm will not occur.</p> <p>If the operator does not perform a reset within 180 seconds, an alarm will occur automatically.</p>

- Press .

Heat Detector Sensitivity

Use this feature to set the temperature that heat detectors will respond. The range is 135° to 150° F. All detectors in the zone will respond in the same way.

The Model SD505-AHS Heat Detector is an absolute temperature device. This means that it responds to an alarm immediately if the temperature in the zone goes above the programmed temperature.

5. Enter the temperature that the heat detector will respond.

Or

Use the ▼ or ▲ keys to scroll through the range or enter directly from the number keys on the annunciator.

Then press .

Smoke Detector Sensitivity

IMPORTANT!

Drift compensation is automatic for all smoke detectors (photoelectric and ionization). The feature is always in effect, no programming is required. See Section 8.4.10 for information about how to check if a detector is in UL compliance.


All detectors in the zone will respond as programmed in this menu location.

Table 7-2: Detector Sensitivity Choices

Type of Smoke Detector	Choices	Comments
Photoelectric Smoke Detector	Low (3.5% obscurity)	If the day/night sensitivity option is selected, you can have different sensitivity settings during the day and at night. You can determine the days of the week that Day/Night Sensitivity will automatically adjust. You can also designate specific days as Holidays. Holiday and weekend days will use night sensitivity for the entire day
	Medium (2.5% obscurity)	
	High (1.5% obscurity)	
Photoelectric duct Detector	See Note.	Low, Medium and High settings have no effect for photoelectric duct detectors. Photoelectric duct detector sensitivity is always 1.1% per foot. Day and night settings also have no effect on these detectors.
Ionization Smoke Detector	See Note.	Sensitivity for ionization detectors is always 64 MIC (1.1% obscurity per foot) regardless of Low, Medium or High setting. Day and night settings also have no effect on these detectors.
Ionization Duct Detector	See Note.	Low, Medium, or High settings have no effect for ionization duct detectors. Ionization duct detector sensitivity is always 75 MIC (0.8%) regardless of Low, Medium or High setting. Day and night settings also have no effect on these detectors.

Note: Automatic drift compensation is always in effect for all detectors. See Section 8.4.10 for information about how to check if a detector is in compliance.

6. Use the ▼ or ▲ keys to scroll through the range or enter directly from the number keys on the annunciator.

7. Then press .

7.2.1.3 Zone Outputs

Output groups and cadence patterns are mapped to events. They can be programmed to output when an event occurs in a zone. Some system trouble events can be mapped for the entire system. Section 6.2 of this manual contains a general explanation of mapping. The following sections explain how to select mapping options.

Mapping to Zone Events

Eight types of events can occur in zones. For each event type, you can activate up to 8 output groups or output group template, specifying a pattern for each.

Event types are:

- Manual Pull Alarm
- Water Flow Alarm
- Detector Alarm (heat or smoke detectors)
- Aux 1 and Aux 2 Alarm (user-specified alarm types)
- Pre-alarm
- Supervisory
- Trouble

To map zone events to outputs, follow these steps:

1. From the Installer Main Menu, select **7** for Program Menu.
2. From the Program Menu, select **2** for Zone.
3. From the next menu, select **1** for Edit Zone.
4. Enter the zone number you wish to edit.
5. From the next menu, select **3** for Zone Outputs.
6. From the next screen, a list of 8 event types will display. Select the event type you want to program. A screen similar to the one shown in Figure 7-3 will display. Press **ENTER**.
7. Press the **▽** or **△** key to toggle the the group letter to either G = Group or T = output group template depending on what you need for this zone. Press **ENTER**.
8. Select options for each event that could occur in this zone. Figure 7-3 is a complete example of how you might map a zone.

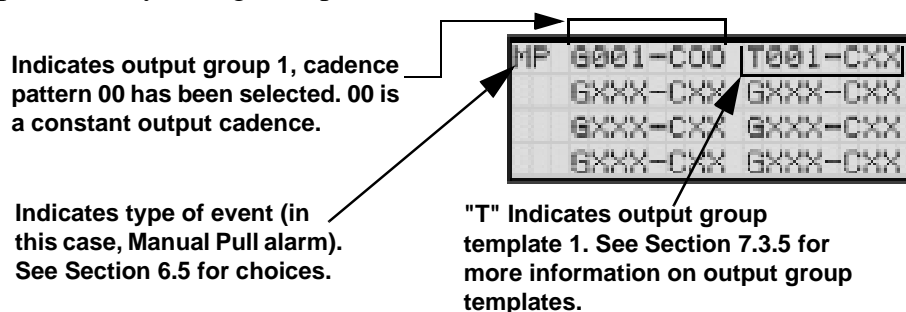


Figure 7-3 Selecting Output Groups/templates and Cadence Patterns for a Zone Event

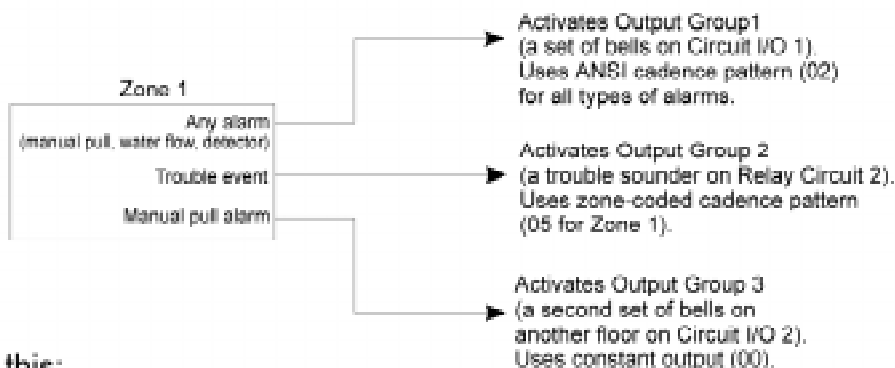
Example or Zone Mapping:

Suppose you want to program Zone 1 so that:

- Any alarm (detector, water flow or manual pull) would activate Output Group 1 using the ANSI cadence pattern.
- Manual pull alarm would activate Output Group 3 using constant output.
- Troubles would activate Output Group 2 using the zone-coded cadence pattern.

To accomplish this you need to access the screen for each event and then select your output groups. Figure 7-4 shows how you would program this application.

For this application:



Program like this:

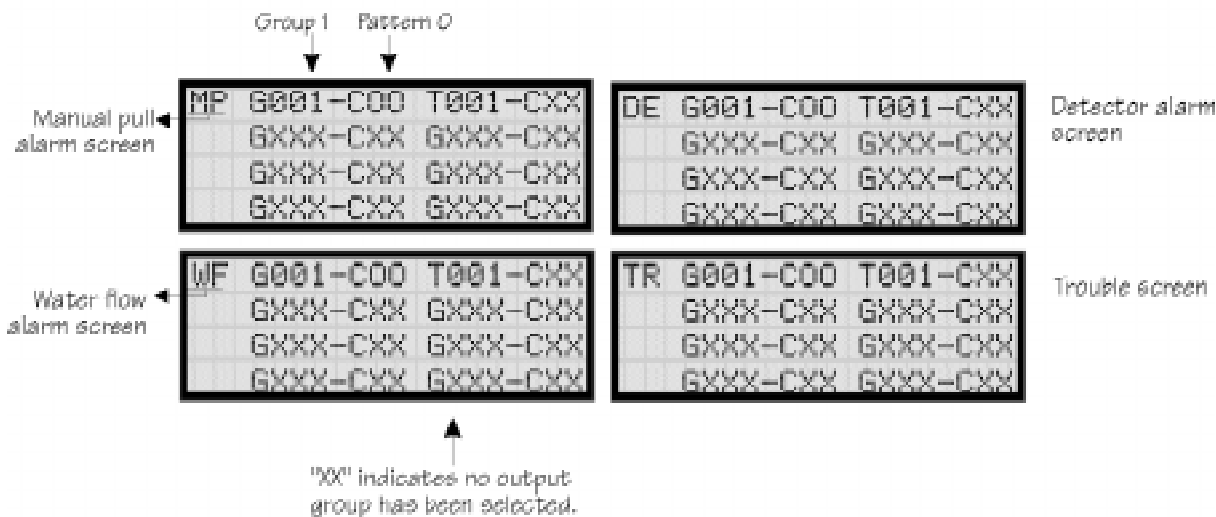


Figure 7-4 Zone Mapping Example

7.2.1.4 Cadence Patterns

The cadence patterns shown in Figure 7-5 are available for use with the control panel.

Cadence patterns can be selected by event type for each zone or for the entire system. Special cadence patterns can be selected for fire drills and any auxiliary system switches used with the system..


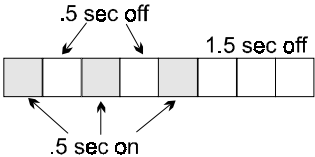
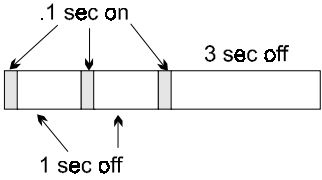


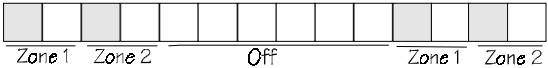
#	Name	Pattern Description																		
00	Constant	Continuous sound Note: This is the only pattern that can be used for relay circuits. The system will override any other choice.																		
01	March Code	 .5 sec on .5 sec off																		
02	ANSI 3.41																			
03	Single Stroke																			
04	California																			
05 ⋮ 12	Zone Coded <table border="1" style="width: 100%; border-collapse: collapse;"> <thead> <tr> <th>Pattern #</th> <th>Zone</th> </tr> </thead> <tbody> <tr><td>5</td><td>Zone 1</td></tr> <tr><td>6</td><td>Zone 2</td></tr> <tr><td>7</td><td>Zone 3</td></tr> <tr><td>8</td><td>Zone 4</td></tr> <tr><td>9</td><td>Zone 5</td></tr> <tr><td>10</td><td>Zone 6</td></tr> <tr><td>11</td><td>Zone 7</td></tr> <tr><td>12</td><td>Zone 8</td></tr> </tbody> </table>	Pattern #	Zone	5	Zone 1	6	Zone 2	7	Zone 3	8	Zone 4	9	Zone 5	10	Zone 6	11	Zone 7	12	Zone 8	 .5 sec on .5 sec off <p style="text-align: right;">This pattern multiplied by # of zone in alarm, followed by 3 seconds off.</p> <p style="text-align: center;">EXAMPLE: Pattern 06, Zone 2 coded</p> 
Pattern #	Zone																			
5	Zone 1																			
6	Zone 2																			
7	Zone 3																			
8	Zone 4																			
9	Zone 5																			
10	Zone 6																			
11	Zone 7																			
12	Zone 8																			

Figure 7-5 Cadence Patterns Available with the Control Panel

Example of Group Name:

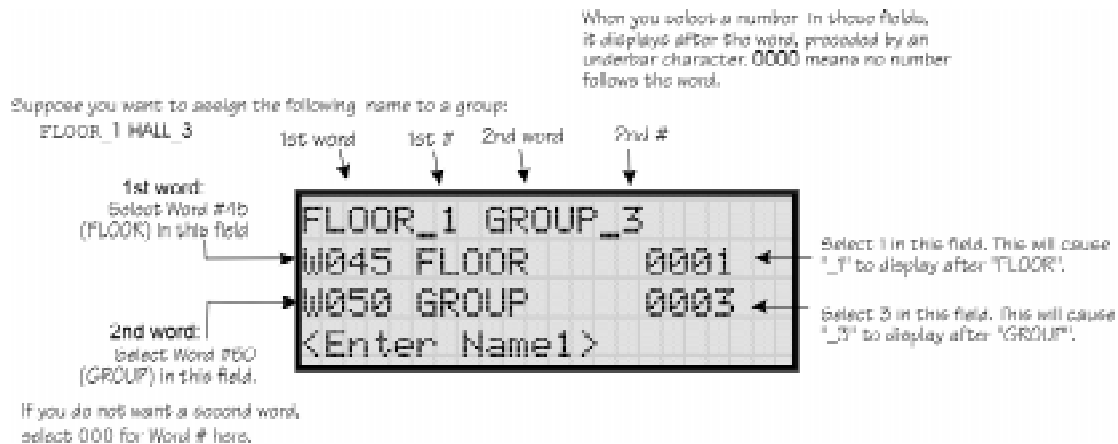


Figure 7-7 Editing Group Name Example

7.3.1.2 Edit Group Properties

The Edit Group Menu allows you to select options for each group for the following items:

- Latching or non-latching outputs.
- Silencing operation.
- Operation with system switches.

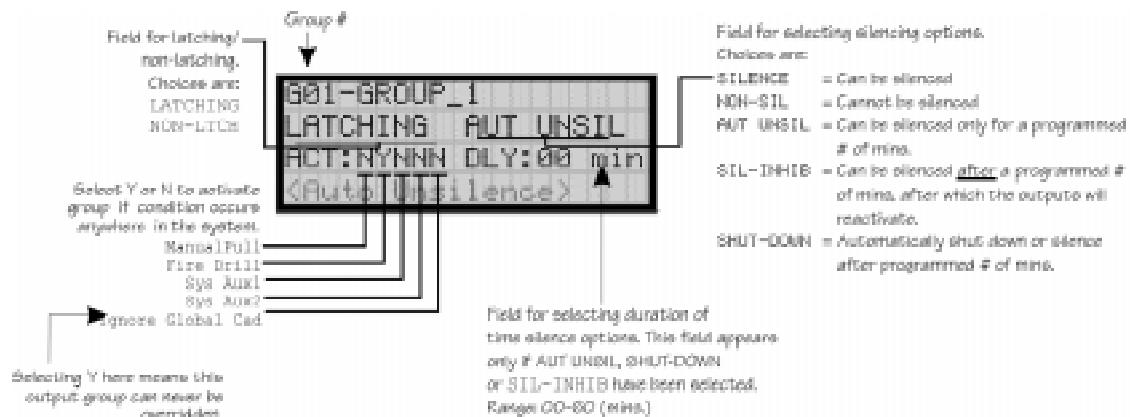


Figure 7-8 Group Properties Screen Programming Options

Latching / Non-latching Outputs

Outputs that are programmed as Latching remain active until the system has been manually reset. Non-latching outputs stop activating automatically when the condition clears.

Silencing Options

The following silencing options are available for each output group.

Table 7-3: Silencing Options

Option	Description
SILENCE	Silenceable. The output group can be silenced through the SILENCE key.
NON-SIL	Not silenceable. The output group cannot be silenced. Activation of the SILENCE key will be ignored for this output group.
AUT UNSIL	Auto Unsilenced. If this option is selected, the output group can be silenced for a programmed time-frame. If the condition that caused the output to activate has not cleared during the time-frame, the output reactivates. If you select this option, select the time-frame in the DLY: field. Range is 00-60 minutes. (See Figure 7-8 for location of field.)
SIL-INHIB	Timed Silence after Inhibit. If this option is selected, the output group must be audible for a programmed number of minutes before it can be silenced. If the condition that caused the output to activate has not cleared during the time-frame, the output can be silenced. If you select this option, select the timeframe in the DLY: field. Range is 00-60 minutes. (See Figure 7-8 for location of field.)
SHUT-DOWN	If this option is selected, the output group will automatically silence (shut down) after the programmed time period. If you select this option, select the timeframe in the DLY: field. Range is 00-60 minutes. (See Figure 7-8 for location of field.)

Response with System-Wide Conditions

You can select whether an output group will respond to various system-wide occurrences. (See Figure 7-8 for location of this field.)

Table 7-4: Output Group Response Choices

Option	Description
ManPull	Manual Pull Activation. Select Yes if you want this group to activate for all manual pull alarms that occur in the system. <i>Note: Even though manual pull switches are assigned to zones, activation selected here for manual pull will override zone-programmed activation.</i>
Fire Drill	Fire Drill Activation. Select Yes if you want this group to activate for fire drills.
Sys Aux1 and Sys Aux2	Select Yes if you want this output group to activate for system-wide Aux1 and Aux2 alarms. (Aux 1 and Aux 2 alarm types are for auxiliary alarm conditions. For example, you might want to use Aux 1 to provide a unique alarm type and sound for a severe weather condition like a tornado.)
Ignore Global Cad	Ignore Global Cadence. If you want to create an output group that can never be overridden, you can select Yes for this option. Selecting No means that system-wide events that have been assigned an output pattern could override the pattern for the output group. For example, suppose you had assigned a set of strobes to Output Group 3. You would never want these strobes to output in a pattern under any circumstances. To make sure this happens, select Yes for Ignore Global Cadence for Output Group 3.

8. To get to this menu item repeat steps 1 through 6 of section 7.3.1.
9. To edit group properties, press **2**.

7.3.5 Edit Output Group Templates

Some installations may require that zones be mapped to more than 8 output groups. With output group templates you can combine one or all output groups into one template, which can be used when the same combination of outputs are used for several zones.

For example, lets say an installation has five zones (See Table 7-5). The check mark indicates what output groups are mapped to each zone. You will notice that every zone is mapped to outputs 1 and 2. As an alternative you can create a template that combines output group 1 and 2 as one choice.

Table 7-5: Zone Group Example

Zone	Group Number							
	1	2	3	4	5	6	7	8
1st Floor Smoke Detectors	✓	✓			✓			
2nd Floor Smoke Detectors	✓	✓			✓			
3rd Floor smoke Detectors	✓	✓			✓			
Manual Fire Pull Stations	✓	✓					✓	
Water Flow Switches	✓	✓						✓

This can be done by creating a template which includes output groups 1 and 2. Then you can map all the zones to the template you created. This will free up output group assignments that are common to several zones. This is very useful when you need to map zones to more than eight output groups.

To create Output Group Templates:

1. From the Installer Main Menu, select [7] for Program Menu.
2. From the Program Menu, select [3] for Group.
3. At the next screen, select [5] for Edit OPG Template.
4. Select the template number (01 - 08).
5. Select output group number. See Figure 7-9.

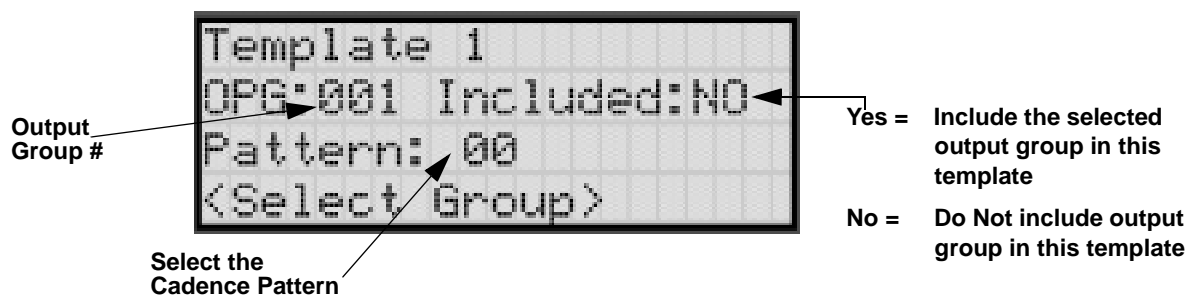





Figure 7-9 Output Group Template Programming Screen

7.4 Point






You may need to change characteristics of individual input points (detectors and switches) even after using JumpStart. This section explains how to change options for: type of input point; latching/non-latching status (switches); and name and zone assignment of a point.

7.4.1 Point Programming For 5815XL Module

To program for an 5815XL Module points, follow these steps:

1. Enter the installer code.
2. Press  or  to display the installer menu.
3. Select  for Program Menu.

```
Display reads:           Initializing
                    Please wait . . .
```

4. Press  to enter point menu.
5. Press the  or  arrows to select the desired module. refer to Section 6.5 Quick Reference Table for available choices.
6. Press .
7. Enter the number of the point you wish to edit.
8. Press .

9. Select the type of device by pressing the ▼ or ▲ arrows. Refer to Table 7-6 under column heading "Type Selection" for a list of choices.


Table 7-6: Point Programming Options for 5815XL Modules

Module Type	Type Selection	Function	Latching Option	Comments	
Internal and External 5815XL	UNUSED				
	DETECTOR	PHOTO			
		ION			
		HEAT			
		PHOT DUCT			
		ION DUCT			
	SWITCH	MAN_PULL			Use this switch type for manual pull stations. This input is always latched. The switch can clear only when an alarm is reset. This switch type has the highest priority; it overrides any other type of alarm.
		WATERFLOW	Latching		Use this switch type for monitoring water flow in a sprinkler system. Switch closure will cause a sprinkler alarm. Water flow switches can be programmed as latching or non-latching. You can program a delay of up to 90 seconds to be used with a water flow switch. The delay allows for normal, brief changes in sprinkler system water pressure. The water flow alarm will not activate unless the switch is active for the programmed delay time.
			Non Latching		If a delay is used, the system begins counting down when the switch closes. If the switch opens (restores) before the timer expires, a water flow alarm is not generated. If the water flow switch remains closed after the timer expires, a water flow alarm will be generated.
		SUPERVISY	Latching		Use this switch type for tamper monitoring of sprinklers and other fire protection devices. If a contact closes, a sprinkler supervisory event will be generated. Supervisory switches can be latching or non-latching.
			Non Latching		
		FIREDRILL			System-level, non latching switch. This switch is an alternative way of causing a fire drill. It has the same operation as the fire drill option available from the annunciator. When the switch is activated, a fire drill begins; when the switch is de-activated, the fire drill ends.
		SILENCE			This system-level switch is an alternative way to silence the system. It has the same effect as pressing the SILENCE key.
	RESET			This system-level switch is an alternative way to reset the system. It has the same effect as pressing the RESET key.	

Table 7-6: Point Programming Options for 5815XL Modules

Module Type	Type Selection	Function	Latching Option	Comments
Internal and External 5815XL (Continued)	SWITCH (Continued)	PAS_ACK		Positive acknowledge switch. This switch must be used in zones programmed as Positive Alarm Sequence (see Table 7-2). If an acknowledge switch closes when an alarm or trouble condition is not already in progress, a trouble will occur. You must use a UL listed normally open, momentary switch type. The switch must be rated at 5V, 100 mA (minimum) and be used with an EOL resistor for supervision.
		ZN_AUX1	Latching	Use these switch types if you want to monitor special zone-level conditions (such as operation of a fan or damper).
			Non Latching	
		ZN_AUX2	Latching	
			Non Latching	
		SYS_AUX1	Latching	Use these switch types if you want to monitor special system-wide conditions (such as operation of a fan or damper).
			Non Latching	
		SYS_AUX2	Latching	
			Non Latching	
		DETECT SW		Used to monitor conventional 4-wire detectors, a contact closure will generate a detector alarm event.
	TAMPER	Latching	Performs identically to a supervisory switch, but will be indicated as a tamper switch on the LCD annunciator.	
		Non Latching		
	NOTIF	OUTPUT PT	Select Group	Output Point, a general use notification type. Use for driving standard notification appliances.
		AUX CONST	Select Group	Use constant power for applications that require a constant auxiliary power source. Power is always present at Constant circuits.
		AUX RESET	Select Group	Use for auxiliary power, resettable applications. See Section 4.12.5.3 for a description of how this option operates.
		AUX DOOR	Select Group	Use for auxiliary power, door holder applications. For example, if you were using an auxiliary power supply for door holders, you would use this option. See Section 4.12.5.1 for a description of how this option operates.
	RELAY	OUTPUT PT	Select Group	Output Point, a general use relay type. Use for applications requiring a relay, such as fan shutdown, elevator recall, and so on.
		AUX RESET	Select Group	Use for auxiliary power, resettable applications. See Section 4.12.5.3 for a description of how this option operates.
AUX DOOR		Select Group	Use for auxiliary power, door holder applications. For example, if you were using an auxiliary power supply for door holders, you would use this option. See Section 4.12.5.1 for a description of how this option operates.	

13. Select the zone by pressing the ▼ or ▲ arrows.

14. Press .

15. Edit point name. See Section 7.4.3.1.

Or

Press ► to skip point name edit.

16. Repeat Steps 1 through 15 for all circuits.














Table 7-7: Menu choices for Internal/External Power Module

Choices	Type Selections	Function Selections for each Type	Comments
Enter Point or Circuit			
Select Type	UNUSED		
	B NOTIF		
	A NOTIF		
	AUX PWR	CONSTANT	Constant auxiliary power.
		RESETTABLE	Resettable auxiliary power.
		DOOR	Door holder auxiliary power.
	B SWITCH	MAN PULL	Refer to comments column of Table 7-6 for description of these options. Latch or Non-latching feature only appears for waterflow, supervisory, tamper, zone aux1, zone aux2, system aux1, and system aux2.
		WATERFLOW	
		SUPERVSY	
		TAMPER	
		FIREDRILL	
		SILENCE	
		RESET	
		PAS_ACK	
		ZN_AUX1	
		ZN_AUX2	
		SYS_AUX1	
	SYS_AUX2		
	A SWITCH	Same as B SWITCH	Used for
	B DETECTOR	2-WIRE SMK	Used for Class B, 2-wire detectors.
		4-WIRE SMK	Used for Class B, 4-wire detectors.
	A DETECTOR	2-WIRE SMK	Used for Class A, 2-wire detectors.
		4-WIRE SMK	Used for Class A, 4-wire detectors.
UNUSED			
B NOTIF			
A NOTIF			
Select Zone/Group			Group or Zone selection will appear depending on the type selected.
Edit Name			See Section 7.1.1.1.

7.4.3.1 Assigning a Name to a Points

You can assign a name to a point to make it easier to recognize on a display.

If you wish to edit the name of a point, follow these instructions:

1. When the Display is flashing on the Edit Name field press .
2. Enter the number for the Name1 or press the  or  arrow to select Name1. Refer to Appendix B Table B-1.
3. Press .
4. Enter Number1 or press the  or  arrow to select Number1.
5. Press .
6. Enter the number for the Name2 or press the  or  arrow to select Name2. Refer to Appendix B Table B-1.
7. Press .
8. Enter Number2 or press the  or  arrow to select Number2.
9. Press .

If you wish to bypass the Edit Name field press .

7.5.1.1 Edit Accounts

6. From the next menu, select for Edit Account.

A screen similar to one shown in Figure 7-11 will display. The following subsections describe the options on each field.

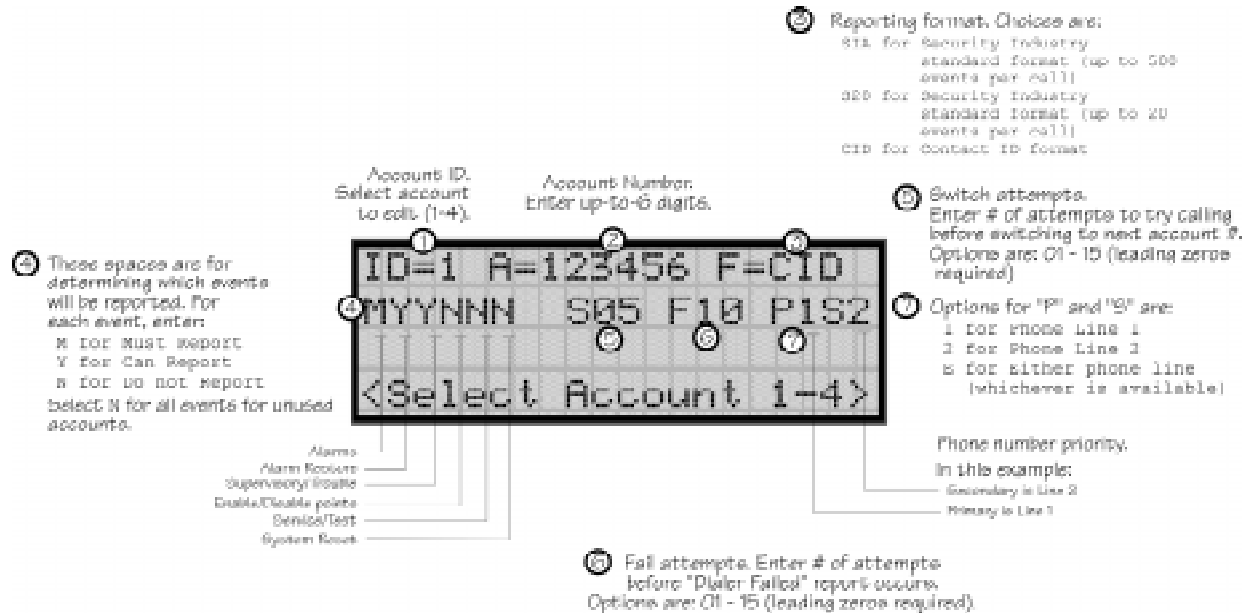


Figure 7-11 Reporting Account Editing Screen

Select Account (ID)

The control panel provides up to 4 reporting accounts. The priority of an account is based on its account ID. Account 1 is highest priority; Account 4 is lowest. Use Account 1 to report the highest priority events.

7. Press the or arrow to select account ID number, then press .

Edit Account Number




Enter an up-to-6-digit number for each account to identify the account to the central station. See Figure 7-11 for location of this option on the screen. The account number should be compatible with the reporting format used. For example, the Contact ID format transmits up to four digits only.

8. Enter the desired account number (up to 6-digits), then press .

Select Reporting Format

Select a reporting format for each account. Options are:




SIA	SIA format. 500 events per call.
CID	Ademco's Contact ID format
S20	Same as SIA but limits events reported to 20 events per phone call.

9. Press the  or  arrow to select the reporting format, then press .

Events to Report

The next six options select which types of events (or event families) will be reported to this account. (See Figure 7-11 for location of these options on the screen.) Events are reported by zone.

Event Family	Events Included in this Family
Alarms	All alarms (Water Flow, Manual Pull, Detectors, Auxiliary Switches)
Alarm Restore	All alarm restores.
Supervisory/Trouble	All trouble and supervisory conditions and trouble and supervisory restores.
Enable/Disable Point	Enabling and disabling of input and output points.
Service/Test	Fire drill, walk test, dialer test, automatic test, all programming sessions.
System Reset	All system resets.

10. Press the  or  arrow to select Must, Yes, or No (see Table below), then press .




11. Repeat step 10 for all six event report options.

For each event family, select M, Y, or N.

M(ust)	Must Report. Selecting "M" makes this a primary reporting account for this family of events. The dialer MUST report events in this family to this account. Selecting Must makes an account a primary reporting account. The dialer will try to report the event to the primary account until it exceeds the "Switch Attempts" value. When the dialer has exceeded the Switch Attempt retry limit, it will switch to a backup account (a "Can Report" or "Yes" account, see below). If the dialer cannot report the event to any of the backup accounts, it will return to the primary account and repeat the process until it exceeds the "Fail Attempts" value. If the Fail Attempts limit is exceeded, an Account Trouble condition is generated and a local trouble will sound.
Y(es)	Can Report. Selecting Y makes this a backup account for this event family. The dialer will report to this account only if it was previously unable to report the event to a Must account.
N(o)	No events in this family will ever be reported to this account.


Switch Attempts

Specify the number of times the dialer should attempt to report to this account before switching to the next account. Range is 01-15.

12. Enter the number of switch attempts (or press the  or  arrow), then press .


Fail Attempts

This feature specifies the number of times the dialer should attempt to perform the dial/switch sequence before issuing an account trouble condition. Range is 01 - 15 (Default = 10).

13. Enter the number of fail attempts (or press the ▲ or ▼ arrow), then press .

Selecting Primary and Secondary Phone Lines

For each account, select which phone line (Line 1 or Line 2) is primary. See Figure 7-11 for an example of how to make this selection.

14. Press the ▲ or ▼ arrow to select line 1 or 2 as primary phone line, then press .

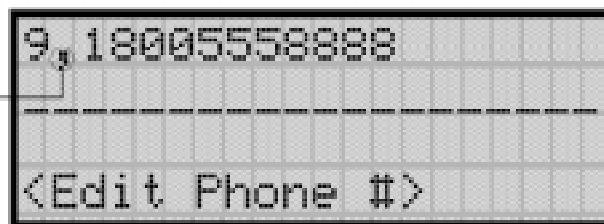
15. Repeat step 14 for the secondary phone line.

Telephone Number

Enter up to 40 characters for phone number for this account.

Enter up to 40
characters for the
phone of the account.

Comma adds a 2
second pause.



The following special characters are available:

Table 7-8: Special Character for Dialing

#	Pound (or number) key on the telephone
*	Star key on the telephone
,	Comma (character for 2-second pause)

Use the number buttons on the annunciator or the up- and down-arrow keys to select special characters. Characters begin displaying after "9". See Figure 7-11 for an example.

6. Select the phone line to be edited (1 or 2) by pressing the \blacktriangle or \blacktriangledown arrow, then press

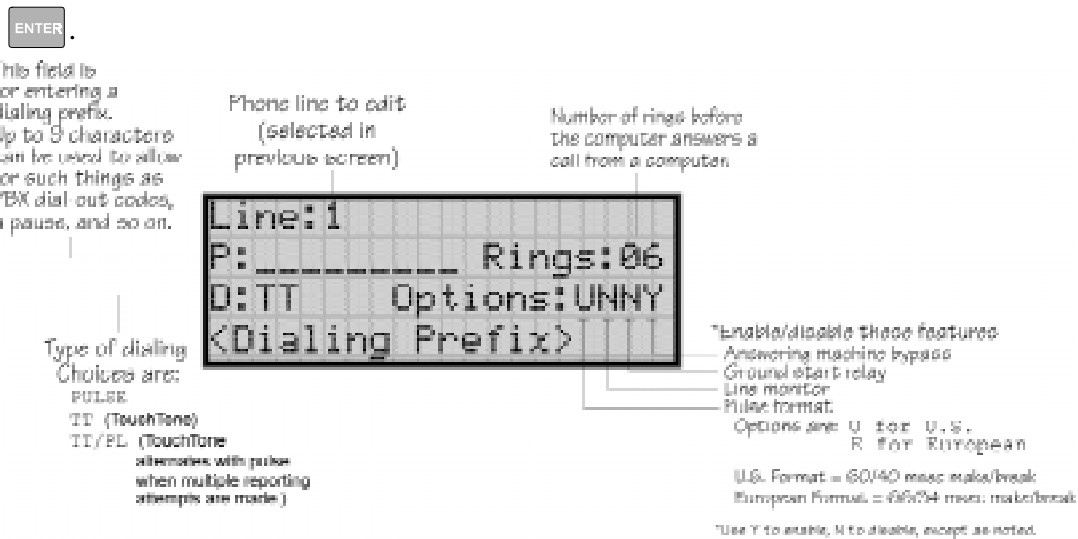


Figure 7-12 Phone Lines Editing Screen

7.5.2.1 Dialing Prefix

Enter up to 8 characters to be used for such things as PBX dial-out codes, a pause, and so on. The following special characters are available:

- # Pound (or number) key on the telephone
- * Star key on the telephone
- , Comma (character for 2-second pause)

Use the number buttons on the annunciator or the up- and down-arrow keys to select special characters. Characters begin displaying after "9". See Figure 7-12 for an example.

7. Enter a dialing prefix (if needed), then press .

Or

Press \blacktriangleleft to bypass the dialing prefix option.

7.5.2.2 Number of Answer Rings

This option is used in conjunction with the SK Analog Fire System Editor 5590. Use the option to determine the number of rings before the panel answers a call from the computer. Range is 00-15 rings. This option is factory-programmed as 06 rings, which should be compatible for most installations where the answering machine bypass feature is used. You may need to adjust it depending on the installation's telephone system.

The selection made here must match the programming for this option in the Communication Configuration dialog box of the 5590 software. See the manual for the software (p/n 151004) if you need more information.




8. Enter the desired number of answer rings, then press .

7.5.2.3 Dial Option (TouchTone or Pulse)

9. Press the  or  arrow to select the dial option, then press .

Dial Option	Description
PULSE	If this option is selected, only pulse dialing will be used for this phone line.
TT	TouchTone dialing. If this option is selected, only TouchTone dialing will be used for this phone line.
TT/PL	TouchTone alternating with pulse. If this option is selected, the dialer will first attempt to use TouchTone. It will switch to pulse if TouchTone is not successful on the first attempt. It will continue to alternate between TT and pulse for additional attempts.

7.5.2.4 Rotary Format

10. Press the  or  arrow to select the pulse ratio for rotary dialing option, then press .

Options are:

- U U.S. standard format. Uses the 60 msec / 40 msec make/break ratio.
- E European format. Uses the 66 msec / 34 msec make/break ratio.

7.5.2.5 Line Monitor




Enable the line monitor for each phone line that will be used. See Figure 7-12 for location of this field on the phone lines screen. When the phone line monitor has been enabled for a phone line, a trouble condition will occur if the line is not connected. If a phone line will not be used, it must be disabled.

11. Select Y (monitor line) or N (don't monitor line) by pressing the  or  arrow, then press .

7.5.2.6 Ground Start Relay

If the ground start relay (Model 5211) is used, use this option to enable it. See Figure 7-12 for location of this field on the phone lines screen. This option is disabled by default.

Note: Ground start cannot be used in UL installations.

12. Select Y (ground start used) or N (ground start not used) by pressing the  or  arrow, then press .

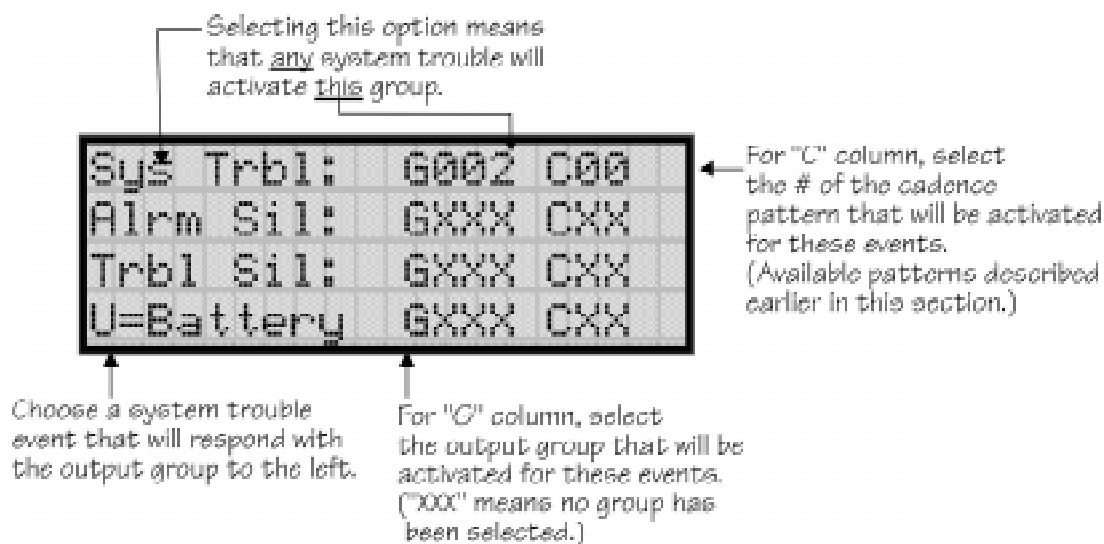


Figure 7-13 System Trouble Event Mapping Example

7.5.3.2 System Alarm Cadence

Fire drill and system auxiliary alarm events can have special cadence patterns to distinguish them from other types of alarms. See Section 7.2.1.4 for available cadence patterns.

A typical use of the System Aux1 and Aux2 patterns is to distinguish fire emergencies from other types of emergencies (such as a tornado or other weather condition). For example, you could use one pattern for fire drills and a different pattern for a tornado condition. The System Aux1 and Aux2 alarms would be triggered by a system-wide switch.

To access the screen for selecting output groups and cadence patterns for system trouble events:

1. Enter the installer code.
2. Press **▶** or **ENTER** to display the installer menu.
3. Select **7** for Program Menu.
 Display reads: Initializing
 Please wait . . .
4. From the Program Menu, select **5** for System Options.
5. From the System Options Menu, select **3** for Sys. Event Outputs.

- Press **2** for System Alarm Cadence.

A screen similar to the one in Figure 7-14 will display. Select a cadence pattern for these special events if required for your application.

```

Fire Drill Cad =00
System Aux1 Cad=00
System Aux2 Cad=00
<FireDrill Cadence>

```

Figure 7-14 Special Cadence Patterns for Fire Drill and Auxiliary Alarm Events

7.5.4 Day/Night Sensitivity Time

If you need to change the time that sensitivity levels take effect (that is, the time that "Day" and "Night" begin), follow these steps.

- Enter the installer code.
- Press **▶** or **ENTER** to display the installer menu.
- Select **7** for Program Menu.
Display reads: Initializing
 Please wait . . .
- From the Program Menu, select **5** for System Options.
- From the System Options Menu, select **4** for Day/Night Sense.

A screen similar to the one shown in Figure 7-15 will display.

```

Enable Day/Night: YES
Day Start: 06:00AM
Night Start: 06:00PM
Days of week: -MTWTF-

```

Enable Day / Night.
If disabled, *day sensitivity
is in effect at all times.

Day start time

Night start time

*Sensitivity levels are
programmed in Zones Menu.

In this example, Day time sensitivity levels will be observed between 6:00 AM and 6:00 PM Monday through Friday. Night time sensitivity levels will be observed between 6:00 PM and 6:00 AM Monday through Friday and all day on Saturday and Sunday.

Figure 7-15 Changing Day/Night Sensitivity Time

7.5.6.2 Low AC Report Delay

Note: You must select 6-12 hours in UL central station installations or 15-30 in UL remote signaling installations.

You can adjust the number of hours before a Low AC report will be sent to the central station.

To program low AC report delay, follow these steps:

Note: Steps continued from step 6 of Section 7.5.6.1.



Figure 7-19 Low AC Report Delay Programming Screen

7. Enter the number of hours before a low AC report will be sent to the central station, then press . Refer to Figure 7-19.

7.5.6.3 Automatic Daylight Savings Adjustment

The control panel has an automatic DST (daylight savings time) adjustment feature. If this feature is enabled, the system clock will switch to DST on the first Sunday in April at 2:00 a.m. The system clock will revert to standard time on the last Sunday in October at 2:00 a.m.

To enable or disable DST adjustment continue programming from step 7 above:

8. Select Y (enabled) or N (disabled) by pressing the or arrow, then press .

7.5.6.4 Clock Display Format (AM/PM or Military)

To change the system clock display format, continue programming from step 8 above:


9. Select AMPM (for AM/Pm display format) or MIL (for military or 24 hr display format) by pressing the or arrow, then press .

7.5.8 Edit Banner Message

The banner is the message that displays on the panel LCD when the system is normal, that is, when no alarms or troubles exist and no one is currently using system menus. You can create a customized message, which can be up to 40 characters, two lines of 20 characters each.

If you do not create a customized message, the system will use the internal banner. You cannot change the internal banner.

To customizing the banner display message:

1. Enter the installer code.
2. Press \blacktriangleright or  to display the installer menu.
3. Select $\boxed{7}$ for Program Menu.


Display reads: Initializing
 Please wait . . .

4. Select $\boxed{5}$ for System Options.
5. Select $\boxed{8}$ for Miscellaneous Options.

A screen similar to the one shown in Figure 7-21 will display.



Figure 7-21 Internal Banner Message

6. Press the \blacktriangle or \blacktriangledown arrow to select "Custom", then press .

A screen similar to the one shown in Figure 7-22 will display.

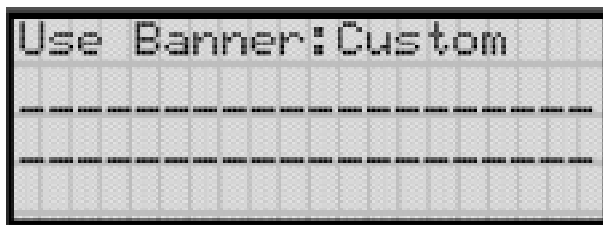



Figure 7-22 Custom Banner Edit Screen

7. Select each character of a word by pressing the \blacktriangle or \blacktriangledown arrow, then press \blacktriangleright to move to the next character.
8. When word or sentence is complete press  to move to line two of the custom banner. Repeat step 7 and 8.




7.7 Computer Account

An installer at the panel site can initiate communications between the panel and a computer running the SK Analog Fire System Editor 5590 (see also Section 8.4.16). In order for this communication to function properly both the computer (running the software) and the control panel must have matching computer account numbers and computer access codes.





Before you program in this location you should know how your control panel will communicate with the downloading computer, either through direct connect (RS232) or via the phone lines (Internal Modem).

If the computer initiates the call to a downloading computer, a phone number must be programmed in the computer accounts area. If the computer initiates the call then answering machine bypass (see Section 7.5.2.7) may need to be selected.

To program computer account information:

1. Enter the installer code.
2. Press  or  to display the installer menu.
3. Select  for Program Menu.

```
Display reads:      Initializing
                  Please wait . . .
```

4. Select  for System Options.
5. Enter the computer account number, then press .
6. Enter the computer code (up to 7-digits), then press .
7. Enter the phone number the panel will dial to connect to a downloading computer (up to 40-digits), then press . See Table 7-8 for special dialing characters.

Section 8

System Operation

Operation of the control panel is simple. Menus guide you step-by-step through operations. This section of the manual is an overview of the operation menus. Please read this entire section carefully before operating the panel.

User Menu (basic operation) access: Rotate the key on the annunciator or enter the User Code (factory-programmed as 1111).

Installer Menu (access to menu that allows for programming and all operations), enter the Installer Code (factory-programmed as 5820).

8.1 Annunciator Description

Figure 10-1 shows the annunciator that is part of the control panel board assembly.

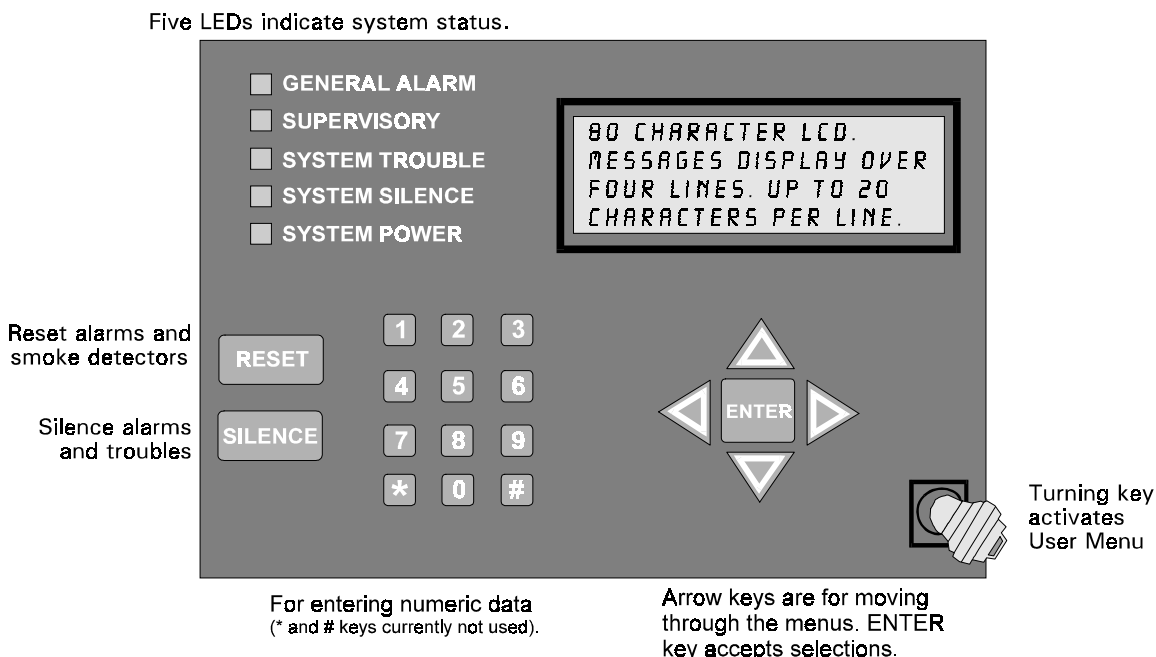


Figure 8-1 Control Panel Annunciator

8.1.1 LCD Displays

The control panel LCD displays system messages, annunciates alarms, supervisories and troubles; provides status information; and prompts for input. These messages can be up to 80 characters, displaying over four lines of 20 characters each. Annunciator keys beep when they are pressed.

8.1.2 Banner

The banner is the message that displays on the control panel when the system is in normal mode (no alarm or trouble condition exists and menus are not in use). You can create a customized message that will display instead of the internal (default) message. See Section 7.5.8 for information on customizing the banner.



Figure 8-2 Banner Display Examples

8.2 Key Operation

The key on the control panel board assembly is for accessing the User Menu for basic system operation. The key is activated when it is turned once to the right (clockwise). If the key has been used to activate the menu, it must be turned counter-clockwise to exit the menu.

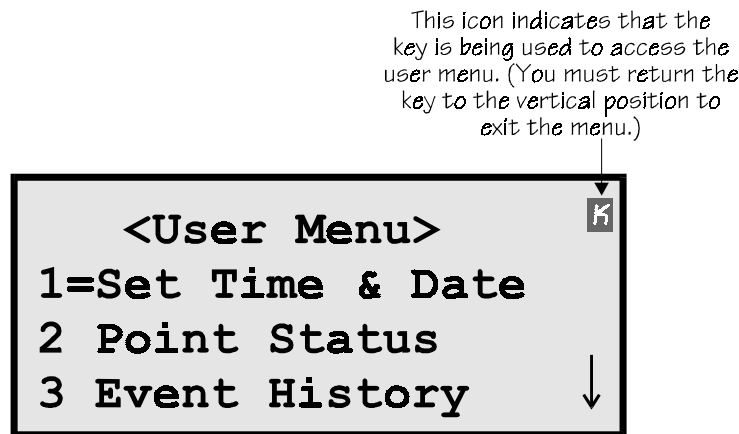


Figure 8-3 Using a Key to Access the User Menu

8.3 Menu System

The control panel is easy to operate from menus that display when you activate the key or enter an access code. The available options will be different depending on how you access the system. If you use the key on the annunciator or the User Code, the User Main Menu will display. If you use the Installer Code, the Installer Main Menu will display.

8.3.1 User Menu

The User Menu is actually a set of menus for basic system operation. It allows you to perform such operations as setting the date and time, disabling points, and silencing and resetting alarms. This menu displays whenever the User Code is entered or the key is activated. (The User Code is factory-programmed as 1111.)

8.3.2 Installer Menu

The Installer Menu is a set of menus for performing all system operation, maintenance, troubleshooting and programming. It includes all functions of the User Menu and many others. This menu displays whenever the Installer Code is entered. (The Installer Code is factory-programmed as 5820.)

8.3.3 Main Menu Overview (User and Installer)

The chart below is a brief overview of the User and Installer Main Menus. These options are described in greater detail throughout this section of the manual.

User Menu	Installer Menu	Description
1 System Tests	1 System Tests	From here both menus can access Fire Drill and Indicator Test. The Installer Menu can access all system tests.
2 Point Functions	2 Point Functions	From here both menus can enable / disable points. The Installer Menu can access the menu for setting SLC device addresses.
3 Event History	3 Event History	Display event history on the LCD. See Section 8.4.3 for more information.
4 Set Time and Date	4 Set Time and Date	Set time and date for the system.
	5 Printer Options	Options for controlling a printer if attached to the system. If a printer is used, the Model 5824 Serial/Parallel Interface must be used.
	6 Reset Dialer	Cancel any attempt to call the central station. Any calls awaiting additional attempts will be aborted.
	7 Program Menu	Brings up a set of menus for programming the panel, including changing access codes. These options are described in detail in Section 7.
	8 System Info	View system information, including model and serial numbers and revision number and date.
	9 Up/Download	Initiate communication from the panel site between the panel and a computer running the SK Analog Fire System Editor 5590.

8.3.4 Using the Menus

To move through the menus:	Use ▼ and ▲ to move through the options in a menu. Use ← to move to a previous menu.
To select an option:	Enter the number of the option. -OR- Press ENTER (Enter key) if the option appears at the top of the menu (= symbol displays after the option number in this case).

8.4 Basic Operation

8.4.1 Setting Time and Date

1. From the User or Installer Main Menu, select **4** for Set Date and Time.
2. Make changes in the fields on the screen. Use ► (right arrow) to move through the fields. Use the ▼ and ▲ to select options in the fields.
3. When the date and time are correct, press **ENTER**.

8.4.2 Disable / Enable a Point

1. From the User or Installer Main Menu, select **2** for Point Functions.
2. Select **1** for Disable/Enable Point. A list of modules displays.
3. Use ▼ and ▲ to move through the list. Press **ENTER** to select the module where the point you want to disable/enable is located. A description of the point should display. The fourth line of the screen should show "NORMAL" (meaning that the point is currently enabled) or "DISABLED" (the point is currently disabled). Press ← to toggle between NORMAL and DISABLE.

8.4.3 View Event History

Use the View Event History feature to display events on LCD. From the User or Installer Menu, press **4** to select Event History. Events will begin displaying with most recent events first.

The panel can store up to 1000 events. When it reaches its 1000-event capacity, it begins deleting, starting with the oldest events.

If a printer is attached to the system (via a Module 5824 Serial/Parallel Interface), you can print event history (see Section 8.4.17).

The SK Analog Fire System Editor 5590 or IntelliView Software can be used to retain more than 1000 events and to create event history reports.

8.4.4 Conduct a Fire Drill

1. From the User or Installer Menu, press **[1]** for System Tests.
2. Press **[1]** for Fire Drill. You will be prompted to press **[ENTER]**.
3. The drill will begin immediately after you press **[ENTER]**.
4. Press any key to end the drill. (If you do not press any key to end the fire drill manually, it will time out automatically after one hour.)

If a fire drill switch has been installed, activating the switch one time will begin the drill; activating a second time will end the drill.

8.4.5 Conduct an Indicator Test

The indicator test checks the annunciator LEDs, PZT, and LCD display.

1. From the Installer Main Menu, press **[1]** for System Tests.
2. Press **[2]** for Indicator Test. The system turns on each LED several times, beeping the PZT as it does so. At the same time it scrolls each available character across the LCD. A problem is indicated if any of the following occurs:
 - An LED does not turn on;
 - You do not hear a beep;
 - All four lines of the LCD are not full.

This test takes approximately 15 seconds to complete. You can press any key to end manually while the test is still in progress. When the test ends, you will be returned to the <Test Menu>.

8.4.6 Conduct a Walk Test

1. From the Installer Main Menu, press **[1]** for System Tests.

IMPORTANT!

If any alarm verification zones are being used, the user will be asked if they wish to disable alarm verification during walk test. This occurs for either walk test option.

2. Select **[3]** for Walk Test-No Rpt. The LCD will display "WALK TEST STOPPED" on Line 1 and "ENTER = start test" on Line 2. If you select this option, central station reporting will be disabled while the test is in progress.

Select **[4]** for Walk Test-with Rpt. The LCD will display "WALK TEST STOPPED" on Line 1 and "ENTER = start test" on Line 2. If you select this option, central station reporting will occur as normal during the walk test.

The panel generates a TEST report to the central station when the walk test begins. During a walk test, the panel's normal fire alarm function is completely disabled, placing the panel in a local trouble condition. All zones respond as 1-Count zones (respond when a single detector is in alarm) during a walk test. Each alarm initiated during the walk test will be reported and stored in the event history buffer.

3. Press **[ENTER]** to end the walk test. The system will reset. The panel will send a "TEST RESTORE" report to the central station.

If you do not end the walk test manually within 60 minutes, it will end automatically.

If an alarm or pre-alarm condition is occurring in the system, you will not be able to enter the walk test.

Note: the panel does not do a full 30 second reset on resettable power outputs. As soon as the device is back to normal, the panel is ready to go to the next device.

8.4.7 Conduct a Dialer Test

1. From the Installer Main Menu, press **[1]** for System Tests.
2. Select **[5]** for Dialer Test. The screen will display "Manual dialer test started". When the test is completed, you will be returned to the <Test Menu>.

8.4.8 Silence alarms or troubles

Press **[SILENCE]** and enter your code or rotate the key at the prompt. If an external silence switch has been installed, activating the switch will silence alarms or troubles. If you are already using system menus when you press **[SILENCE]**, you will not need to enter your code or rotate the key.

8.4.9 Reset alarms

Press **RESET** and enter your code or rotate the key at the prompt. If an external reset switch has been installed, activating the switch will reset alarms. If you are already using system menus when you press **RESET**, you will not need to enter your code or rotate the key.

8.4.10 Check Detector Sensitivity Through Point Status

The control panel constantly monitors smoke detectors to ensure that sensitivity levels are in compliance with NFPA 72.

If sensitivity for a detector is not in compliance, the panel goes into trouble, generating a CAL TRBLE condition. A detector enters a CAL MAINT state to indicate that it is approaching an out of compliance condition (but is currently still in compliance).

When a CAL TRBLE condition occurs, the central station receives a detector trouble report (“373” + Zone # for Contact ID format; “FT” + Zone # in SIA format).

To check sensitivity for an individual detector, follow the steps below. Section 8.4.17 provides instructions for printing the status of all detectors in the system.

1. From the User or Installer Menu, press **2** for Point Functions.
2. Press **2** for Point Status.
3. Select the module where the point you want to check is located.
4. Enter the number of the point you want to check and press **ENTER**.
5. A screen similar to those shown in Figure 8-4 will display.

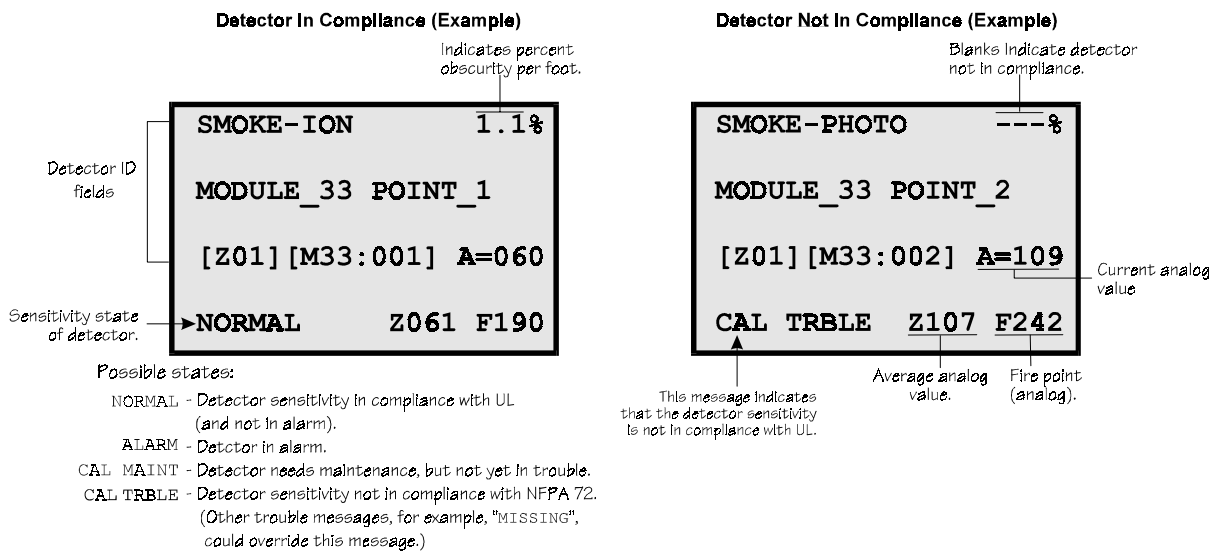


Figure 8-4 Checking Detector Sensitivity Compliance

If a printer is attached to the system (via a Module 5824 Serial/Parallel Interface), you can print detector status (see Section 8.4.17).

8.4.11 Change User or Installer Code

You must be in the Program Menu to perform this step.

1. From the Installer Main Menu, press **[7]** to enter the Program Menu.
2. From the Program Menu, press **[8]** for Access Codes.
3. At the prompt, press **[1]** to change the User Code or **[2]** to change the Installer Code.
4. At the next prompt, enter a 4-to-7-digit number for the new code and press **[ENTER]**.
5. At the <Verify> prompt, enter the code a second time.
6. You will be prompted to save your changes before moving to a new menu. Use the **▼** or **▲** to select Yes or No, if needed, then press **[ENTER]**.

8.4.12 View Status of a Point

1. From the User or Installer Main Menu, select **[2]** for Point Status.
2. From the list that displays, press **[ENTER]** to select the module where this point is located. The screen that displays will show you if the point has a trouble and will provide sensitivity compliance information. (See Section 8.4.10 for complete information about detector sensitivity compliance.)

8.4.13 View Alarms or Troubles

When the system is in alarm or trouble, you can press **▼** to view the location of an alarm or trouble. See Section 8.4.13 for more information.

8.4.14 View System Information

Press **[8]** from the Installer Main Menu to view the panel model and serial number and system version number and date. The information displays for several seconds then returns to the main menu.

8.4.15 Reset dialer

From the Installer Main Menu, select **[6]**. The LCD will display “Dialer reset in progress...” You will be returned to the Installer Main Menu when the reset is completed.

8.4.16 Communicating with a Remote Computer

An installer at the panel site can initiate communications between the panel and a computer running the SK Analog Fire System Editor 5590. You can use this feature to upload a panel configuration. For example, if you have made programming changes to an installation on site using an annunciator, you can send your changes to the computer, so that the central station will have the latest data about the installation. Refer to the 5590 manual (P/N 151004) for complete details about communication hardware set-up. To initiate communication, follow the steps below.

Important!

To ensure proper downloading, make sure that the SK Analog Fire System Editor's revision is equal to or greater than the software revision of the control panel. See Section 8.4.14.

1. From the Installer Main Menu, select **9** for Up/Download.
2. From the next screen that displays, select the communication device. Options are:

1 = Internal Modem	If you select this option, you will use the panel's built-in modem to call the panel.
2 = RS232 connection	If you select this option, the panel and a computer are both on-site connected via a 9-pin straight-through serial cable.
3. If you are using the panel's internal modem to communicate, you will be prompted to enter a phone number. If you are communicating via the RS232 connection, a phone number is not needed and this step will be skipped.

If the phone number you will be calling is already displayed, press **ENTER**. Continue with Step 4.

If the phone number you will be calling is not already displayed, enter the number and press **ENTER**. The number you enter will become the default phone number. A phone number can be up to 40 digits long and can contain the following special characters.

#	Pound (or number) key on the telephone
*	Star key on the telephone
,	Comma (character for 2-second pause)

Use the number buttons on the annunciator or the up- and down-arrow keys to select special characters. Characters begin displaying after "9".

4. You will be prompted to enter an account number. If the account number you want to use is already displayed, just press **ENTER** to begin communication.

If the account number displayed is not the correct one, enter the account number and press **ENTER** to begin communication. The number you enter will become the default account number.
5. The panel will attempt to communicate with the computer. If communication was established, the upload task you created will be placed on the 5590 job queue, awaiting processing. When processing is completed, an "Unsolicited Upload" task will appear in the queue.

8.4.17 Working with a Printer

If you are using the Model 5824 Serial/Parallel Interface, several printing options are available. See Section 4.7 for information about installing the 5824.

1. From the Installer Main Menu, select **[5]** Printer Options.
2. From the next screen, select the 5824 module where the printer is connected.
3. If the printer is not currently busy printing another report, a screen with the following options will be available. If the printer is busy, a message will display. You can press **[1]** to cancel the current print job. These options will then display.

[1] = Event Logging

Enables event logging, which causes the printer to continuously print events as they occur. The date/time will print in 24-hour military format. Once event logging is enabled, it will remain enabled until canceled by the installer. If you need to disable event logging, return to this option and press **[1]** to disable.

Sample Event Log

```

EVENT LOG:                                     STARTED: 02/17/97 02:23
02/17/97 11:23 Event: System Silenced
02/17/97 11:24 Event: System Reset
02/17/97 14:30 Event: Local Programming Begin
02/17/97 15:01 Event: Local Programming Ended Successfully

EVENT LOG:                                     STOPPED: 02/17/97 15:02
    
```

[2] = Print Event History

Prints the up-to-1000 events currently stored in the panel's event history buffer. Events print starting with the newest. The date and time printed will be when the event actually occurred and will print in 24-hour military format.

Sample Event History Print-Out

```

EVENT HISTORY:                                PRINTED: 02/28/97 13:35
02/20/97 09:02 Event 3 of 10: System Silenced
02/20/97 09:05 Event 2 of 10: System Reset
02/22/97 08:47 Event 4 of 10: Printer Off Line 4
02/22/97 08:52 Event 4 of 10: Printer On Line 4
02/25/97 15:54 Event 5 of 10: Local Programming Begin
02/25/97 16:10 Event 5 of 10: Local Programming Ended Successfully
02/28/97 12:50 Event 6 of 10: Walk Test Begin
02/28/97 13:31 Event 2 of 10: Walk Test End
:
:
:
    
```

[3] = Print Detector Status

Prints the current status of all detectors in the system. This is a method for finding out if any detectors are out of NFPA compliance or any detectors need maintenance (are approaching an out of compliance condition).

Sample Detector Status Print-Out

```

DETECTOR STATUS:                             PRINTED: 02/28/97 13:45
NFPA% COMPLIANCE:
PANEL RESET ALARM:
PANEL LIGHT BLINK:
CURRENT PRIORITY BLACK:
SIGNAL ALARM:
TROUBLE THRESHOLD:
Maintenance Threshold:
ALARM THRESHOLD LEVEL:
RECHARGING STATUS OF BATT:
DOOR PULLER:

ID NAME          TYPE  IN  SEND  STL  ROL  RT  TT  CAR  IN  PCA  RA  SORTS
-----
001 MODEL_01     POINT 1 --- 248 141 03 94 148 1141 0 000 000 0
002 MODEL_02     POINT 1 --- 128 128 0 000 000 0 000 000 0
003 MODEL_03     POINT 1 --- 128 128 0 000 000 0 000 000 0
004 MODEL_04     POINT 1 --- 128 128 0 000 000 0 000 000 0
005 MODEL_05     POINT 1 --- 128 128 0 000 000 0 000 000 0
    
```

Note: Detector status can also be viewed and printed using the 5590 SK Analog Fire System Editor or IntelliView Software.

8.5 Operation Mode Behavior

The control panel can be in one of seven conditions at any given moment: Normal, Alarm, Prealarm, Supervisory, Trouble, Silenced, and Reset. Table 10-1 describes the behavior of the panel in each of these modes.

Table 8-1: Operation Mode Behavior



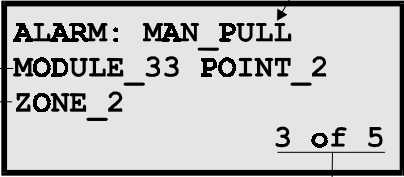
Operation Mode	Occurs When	System Behavior	In This Mode You Can
Normal	No alarm or trouble condition exists and menus are not in use.	<p>SYSTEM POWER LED is on.</p> <p>The All Systems Normal display indicates that the system is in normal mode.</p>  <p>The current date and time display on the last line of the LCD.</p>	Enter the appropriate code to activate the User or Installer Menu, or rotate the key to activate the User Menu.
Alarm	A smoke detector goes into alarm or a pull station is activated.	<p>The dialer seizes control of the phone line and calls the central station.</p> <p>The on-board annunciator sounds a loud, steady beep (any notification devices attached to the system will also sound).</p> <p>GENERAL ALARM LED flashes.</p> <p>The LCD displays a screen similar to this one.</p> <p>Count of alarms in the system In this example there are 5.</p>  <p>Press the down arrow to view the type and location of alarm. (Message alternates with the date/time display.)</p>	<p>Press the down arrow to view the alarm. A screen similar to this one displays.</p>  <p>Module and Point name Device type</p> <p>Zone name</p> <p>Shows which event is currently being displayed. In this example, there are 5 alarms, the third is being displayed.</p> <p>Press SILENCE and enter an access code (or activate the key) to silence the annunciator (and any notification devices attached to the system).</p> <p>When the alarm condition clears, press RESET and enter a code (or activate the key) to restore the panel to normal.</p>

Table 8-1: Operation Mode Behavior

Operation Mode	Occurs When	System Behavior	In This Mode You Can
Supervisory	The system detects a supervisory condition.	<p>The dialer seizes control of the phone line and calls the central station.</p> <p>The on-board annunciator sounds a loud, pulsing beep in the sequence one second on, one second off.</p> <p>SUPERVISORY LED flashes.</p> <p>The LCD displays a screen similar to this one.</p> <p>Count of supervisories in the system In this example there is 1.</p> <div data-bbox="522 661 911 831" style="border: 1px solid black; padding: 5px; text-align: center;"> <p>SUPERVSY cnt[1]</p> <p>Press ↓ for status</p> </div> <p>Press the down arrow to view the type and location of alarm. (Message alternates with the date/time display.)</p>	<p>Press ▼ (down arrow) to view the supervisory condition. A screen similar to this one displays.</p> <div data-bbox="966 394 1430 653" style="border: 1px solid black; padding: 5px;"> <p>Module and Point name Device type</p> <p>SUPERVSY: MAN_PULL</p> <p>MODULE_33 POINT_2</p> <p>ZONE_2</p> <p style="text-align: right;">1 of 1</p> </div> <p>Zone name Shows which event is currently being displayed.</p> <p>Press SILENCE and enter an access code (or activate the key) to silence the annunciator.</p> <p>Once the supervisory condition has been corrected, the system will restore itself automatically.</p>
Trouble	A system trouble condition occurs.	<p>The dialer seizes control of the phone line and calls the central station.</p> <p>The on-board annunciator sounds a loud, pulsing beep in the sequence one second on, nine seconds off.</p> <p>SYSTEM TROUBLE LED flashes.</p> <p>The LCD displays a screen similar to this one.</p> <p>Count of troubles in the system In this example there are 3.</p> <div data-bbox="534 1247 891 1398" style="border: 1px solid black; padding: 5px; text-align: center;"> <p>TROUBLE cnt[3]</p> <p>Press ↓ for status</p> </div> <p>Press the down arrow to view the type and location of trouble condition. (This message alternates with the date / time display.)</p>	<p>Press ▼ (down arrow) to view the trouble. A screen similar to this one displays.</p> <div data-bbox="959 1016 1443 1325" style="border: 1px solid black; padding: 5px;"> <p>TROUBLE SMOKE-PHOTO Device type</p> <p>Module and Point name MODULE_33 POINT_1</p> <p>Zone # [Z02] [M33:001] Module # Point #</p> <p>MISSING 1 of 3</p> </div> <p>Type of trouble. In this example, the panel does not see a detector that should be on the loop. Shows which event is currently being displayed. In this example, there are 3 troubles, 1 is being displayed.</p> <p>Press SILENCE and enter an access code (or activate the key) to silence the annunciator.</p> <p>Once the trouble condition has been fixed, the system will restore itself automatically.</p>

Table 8-1: Operation Mode Behavior

Operation Mode	Occurs When	System Behavior	In This Mode You Can
<p>Prealarm</p>	<p>A single detector trips in a 2-Count zone. (2-Count means two detectors must trip before an alarm is reported.)</p>	<p>Touchpad PZT beeps. The LCD displays a screen similar to this one.</p> <p>Count of alarms in the system In this example there is 1.</p> <div data-bbox="521 499 911 667" style="border: 1px solid black; padding: 5px; text-align: center;"> <p>PREALARM cnt[1]</p> <p>Press ↓ for status</p> </div> <p>Press the down arrow to view the type and location of prealarm. (Message alternates with the date/time display.)</p>	<p>Press ▼ (down arrow) to view the prealarm. A screen similar to this one displays.</p> <p>Module and Point name Device type</p> <div data-bbox="987 426 1398 604" style="border: 1px solid black; padding: 5px;"> <p>PREALARM: SMOKE- PHOTO MODULE_33 POINT_2 ZONE_2</p> <p style="text-align: right;">1 of 1</p> </div> <p>Zone name Shows which event is currently being displayed.</p> <p>All system operations are available in this mode.</p>
<p>Reset</p>	<p>The RESET button is pressed followed by a valid code or rotation of the key.</p>	<p>All LEDs are on briefly then the LCD displays "ALARM RESET IN PROGRESS". If the reset process completes normally, the date and time normal mode screen displays.</p>	<p>Menus are not available during the reset process.</p>
<p>Silenced</p>	<p>An alarm or trouble condition has been silenced but still exists. To silence alarms and troubles, press SILENCE followed by the Installer or User Code or rotate the key.</p>	<p>SYSTEM SILENCE LED is on. SYSTEM TROUBLE, SUPERVISORY or GENERAL ALARM LED (depending on condition) is on. The annunciator (and any notification devices attached to the system) will be silenced.</p>	<p>Press ▼ (down arrow) to view the location of the alarm or trouble. When the condition no longer exists, the SYSTEM SILENCED and SYSTEM TROUBLE LED, SUPERVISORY or GENERAL ALARM LEDs turn off.</p>

Section 9

Reporting

This section lists receivers that are compatible with this control panel, and the reporting codes sent by the control panel for SIA and Contact ID formats.

9.1 Receivers Compatible with the Control Panel

Table 11-1 shows receivers compatible with the control panel.

Table 9-1: Receivers Compatible with the Control Panel

Manufacturer	Model	Format
Silent Knight	Model 9800	SIA and Contact ID
	Model 9000 (SIA formats)	SIA
Ademco	Model 685 (Contact ID)	Contact ID
Sur-Gard	SG-MLR2-DG (V. 1.64 or higher)	SIA and Contact ID
Osborne Hoffman	Quickalert	SIA and Contact ID

9.2 Ademco Contact ID Dialer Output

Table 9-2: Ademco Contact ID Output

Event Description	Event Family	Event Qualifier 1=New, 3= Restore	Event Code	Group #	Zone / Contact ID #
Detector alarm.	Alarm	1	110	00	Zone
Detector alarm restore	Restore/Reset	3	110	00	Zone
Water flow switch alarm.	Alarm	1	113	00	Zone
Water flow switch alarm restore	Restore/Reset	3	113	00	Zone
Manual pull switch alarm.	Alarm	1	115	00	Zone
Manual pull switch alarm restore	Restore/Reset	3	115	00	Zone
Zone based, AUX1 switch alarm	Alarm	1	140	01	Zone
Zone based, AUX2 switch alarm	Alarm	1	140	02	Zone
Zone based, AUX1 switch alarm restore	Restore/Reset	3	140	01	Zone
Zone based, AUX2 switch alarm restore	Restore/Reset	3	140	02	Zone
System-based AUX1 switch alarm.	Alarm	1	140	01	000
System-based AUX2 switch alarm.	Alarm	1	140	02	000
System-based AUX1 switch alarm restore	Restore/Reset	3	140	01	000
System-based AUX2 switch alarm restore	Restore/Reset	3	140	02	000
Supervisory condition	Trouble	1	203	00	Zone
Supervisory restore	Trouble	3	203	00	Zone
Checksum error.	Trouble	1	300	00	000
AC power lost	Trouble	1	301	00	000
AC power restore	Trouble	3	301	00	000
Battery voltage low	Trouble	1	302	Exp ID	000
Battery voltage restore	Trouble	3	302	Exp ID	000
Initial Power Up.	Trouble	1	305	00	000
Ground fault condition detected	Trouble	1	310	Exp ID	000
Ground fault condition restore	Trouble	3	310	Exp ID	000
Aux Power Trouble	Trouble	1	320	00	000
Aux Power Trouble Restore	Trouble	3	320	00	000
Notification output trouble	Trouble	1	320	00	Group #
Notification output trouble restore	Trouble	3	320	00	Group #
SLC Class A supervision lost	Trouble	1	331	Exp ID	000
SLC Class A supervision restored	Trouble	3	331	Exp ID	000
Short detected on SLC communication loop	Trouble	1	332	Exp ID	000
Short removed from SLC communication loop	Trouble	3	332	Exp ID	000
SBUS expander trouble	Trouble	1	333	Exp ID	000
SBUS expander trouble restore	Trouble	3	333	Exp ID	000
SBUS Class A supervision lost	Trouble	1	333	Exp ID	000

Table 9-2: Ademco Contact ID Output

Event Description	Event Family	Event Qualifier 1=New, 3= Restore	Event Code	Group #	Zone / Contact ID #
SBUS Class A supervision restore	Trouble	3	333	Exp ID	000
Printer is out of paper.	Trouble	1	335	Exp ID	000
Printer paper restored.	Trouble	3	335	Exp ID	000
Printer offline.	Trouble	1	336	Exp ID	000
Printer back online.	Trouble	3	336	Exp ID	000
Auto Dialer Test Communication Trouble	Trouble	1	350	0	Line #
Auto Dialer Test Communication Trouble Restore	Trouble	3	350	0	Line #
Phone line 1 trouble detected	Trouble	1	351	00	000
Phone line 1 trouble restore	Trouble	3	351	00	000
Phone line 2 trouble detected	Trouble	1	352	00	000
Phone line 2 trouble restore	Trouble	3	352	00	000
Unable to report to an account	Trouble	1	354	Acct #	Acct #
Report to an account successful	Trouble	3	354	Acct #	Acct #
Water flow switch trouble	Trouble	1	373	00	Zone
Manual pull switch trouble	Trouble	1	373	00	Zone
Detector trouble	Trouble	1	373	00	Zone
Zone-based Aux 1 switch trouble	Trouble	1	373	01	Zone
Zone-based Aux 2 switch trouble	Trouble	1	373	02	Zone
Supervisory switch trouble	Trouble	1	373	00	Zone
Water flow switch trouble restore	Trouble	3	373	00	Zone
Manual pull switch trouble restore	Trouble	3	373	00	Zone
Detector trouble restore	Trouble	3	373	00	Zone
Zone based, AUX 1 switch trouble restore	Trouble	3	373	01	Zone
Zone based, AUX 2 switch trouble restore	Trouble	3	373	02	Zone
Supervisory switch trouble restore	Trouble	3	373	00	Zone
System-based AUX1 switch trouble	Trouble	1	373	01	000
System based AUX 2 switch trouble	Trouble	1	373	02	000
External Reset/Silence/Fire Drill switch trouble	Trouble	1	373	00	000
System-based AUX1 switch trouble restore	Trouble	3	373	01	000
System-based AUX2 switch trouble restore	Trouble	3	373	02	000
External Reset/Silence Fire Drill trouble restore	Trouble	3	373	00	000
Positive Alarm Sequence acknowledge switch trouble	Trouble	1	373	00	Zone
Positive Alarm Sequence acknowledge switch trouble restore	Trouble	3	373	00	Zone
An unexpected SLC device has been detected.	Trouble	1	380	Exp ID	Pnt #
An unexpected SLC device has been removed.	Trouble	3	380	Exp ID	Pnt #
User initiated a system reset	Restore/Reset	1	401	00	000
Remote programming ended normally.	Trouble	1	412	00	000

Table 9-2: Ademco Contact ID Output

Event Description	Event Family	Event Qualifier 1=New, 3= Restore	Event Code	Group #	Zone / Contact ID #
Remote programming aborted or ended with errors.	Trouble	1	413	00	000
Notification output disabled	Disable	1	571	Exp ID	Pnt #
Manual pull switch disabled	Disable	1	571	Exp ID	Pnt #
Water flow switch disabled	Disable	1	571	Exp ID	Pnt #
Conventional detector input has been disabled	Disable	1	571	Exp ID	Pnt #
Addressable photoelectric detector has been disabled	Disable	1	571	Exp ID	Pnt #
Addressable heat detector has been disabled	Disable	1	571	Exp ID	Pnt #
Addressable ionization detector has been disabled	Disable	1	571	Exp ID	Pnt #
Addressable beam detector has been disabled	Disable	1	571	Exp ID	Pnt #
Supervisory switch input has been disabled	Disable	1	571	Exp ID	Pnt #
Tamper switch input has been disabled	Disable	1	571	Exp ID	Pnt #
Zone-based AUX1 switch input has been disabled	Disable	1	571	Exp ID	Pnt #
Zone-based AUX2 switch input has been disabled	Disable	1	571	Exp ID	Pnt #
Positive alarm sequence acknowledge switch has been disabled	Disable	1	571	Exp ID	Pnt #
Detection acknowledge switch has been disabled	Disable	1	571	Exp ID	Pnt #
Fire drill switch has been disabled	Disable	1	571	Exp ID	Pnt #
Silence switch has been disabled	Disable	1	571	Exp ID	Pnt #
Reset switch has been disabled	Disable	1	571	Exp ID	Pnt #
System based AUX 1 switch input disabled	Disable	1	571	Exp ID	Pnt #
System-based AUX2 switch input disabled	Disable	1	571	Exp ID	Pnt #
Constant ON Auxiliary power output has been disabled	Disable	1	571	Exp ID	Pnt #
Resettable auxiliary power output has been disabled	Disable	1	571	Exp ID	Pnt #
Door Holder auxiliary power output has been disabled	Disable	1	571	Exp ID	Pnt #
Notification output has been re-enabled	Disable	3	571	Exp ID	Pnt #
Manual pull switch has been re-enabled	Disable	3	571	Exp ID	Pnt #
Water flow switch has been re-enabled.	Disable	3	571	Exp ID	Pnt #
Conventional detector input has been re-enabled	Disable	3	571	Exp ID	Pnt #
Addressable photoelectric detector has been re-enabled.	Disable	3	571	Exp ID	Pnt #
Addressable heat detector has been re-enabled	Disable	3	571	Exp ID	Pnt #
Addressable ionization detector has been re-enabled	Disable	3	571	Exp ID	Pnt #
Addressable beam detector has been re-enabled.	Disable	3	571	Exp ID	Pnt #
Supervisory switch input has been re-enabled.	Disable	3	571	Exp ID	Pnt #

Table 9-2: Ademco Contact ID Output

Event Description	Event Family	Event Qualifier 1=New, 3= Restore	Event Code	Group #	Zone / Contact ID #
Tamper switch input has been re-enabled.	Disable	3	571	Exp ID	Pnt #
Zone-based AUX 1 switch input has been re-enabled.	Disable	3	571	Exp ID	Pnt #
Zone-based AUX 2 switch input has been re-enabled.	Disable	3	571	Exp ID	Pnt #
Positive alarm sequence acknowledge switch has been re-enabled.	Disable	3	571	Exp ID	Pnt #
A detection acknowledge switch has been re-enabled.	Disable	3	571	Exp ID	Pnt #
A fire drill switch has been re-enabled.	Disable	3	571	Exp ID	Pnt #
A silence switch has been re-enabled.	Disable	3	571	Exp ID	Pnt #
A reset switch has been re-enabled	Disable	3	571	Exp ID	Pnt #
A system-based AUX 1 switch input has been re-enabled.	Disable	3	571	Exp ID	Pnt #
A system-based AUX 2 switch input has been re-enabled.	Disable	3	571	Exp ID	Pnt #
A constant on auxiliary power output has been re-enabled.	Disable	3	571	Exp ID	Pnt #
A resettable auxiliary power output has been re-enabled.	Disable	3	571	Exp ID	Pnt #
A door holder auxiliary power output has been re-enabled.	Disable	3	571	Exp ID	Pnt #
User has initiated dialer test.	Test	1	601	00	Channel #
Periodic test event.	Test	1	602	00	Channel #
Fire drill has begun.	Test	1	604	00	000
Fire drill has ended.	Test	3	604	00	000
Walk test begin.	Test	1	607	00	000
Walk test end.	Test	3	607	00	000
SLC address programming started; system has been shut down.	Test	1	607		
SLC address programming ended; system has been re-enabled.	Test	3	607		
Panel date has been changed.	Trouble	1	625	00	000
Panel time has been changed.	Trouble	1	625	00	000
Local programming begin.	Trouble	1	627	00	000
Remote programming begin.	Trouble	1	627	00	000
Local programming ended normally.	Trouble	1	628	00	000
Local programming aborted or ended with errors.	Trouble	1	628	00	000

9.3 SIA Dialer Output

Table 9-3: SIA Dialer Output

Event Description	Event Family	Module ID# (if any)	SIA Event Code	Parameter (if any)
AC power restore	Trouble		AR	
AC power lost	Trouble		AT	
SBUS expander trouble restore	Trouble		ER	Exp. ID
SBUS Class A supervision restore	Trouble		ER	Exp. ID
Short removed from SLC communication loop	Trouble		ER	Exp. ID
SLC Class A supervision restored	Trouble		ER	Exp. ID
SBUS expander trouble	Trouble		ET	Exp. ID
SBUS Class A supervision lost	Trouble		ET	Exp. ID
Short detected on SLC communication loop	Trouble		ET	Exp. ID
SLC Class A supervision lost	Trouble		ET	Exp. ID
Manual pull switch alarm.	Alarm		FA	Zone
Detector alarm.	Alarm		FA	Zone
Notification output disabled	Disable	pi Exp. ID	FB	Pnt #
Manual pull switch disabled	Disable	pi Exp. ID	FB	Pnt #
Conventional detector output has been disabled	Disable	pi Exp. ID	FB	Pnt #
Addressable photoelectric detector has been disabled	Disable	pi Exp. ID	FB	Pnt #
Addressable heat detector has been disabled	Disable	pi Exp. ID	FB	Pnt #
Addressable ionization detector has been disabled	Disable	pi Exp. ID	FB	Pnt #
Addressable beam detector has been disabled	Disable	pi Exp. ID	FB	Pnt #
Positive alarm sequence acknowledge switch disabled	Disable	pi Exp. ID	FB	Pnt #
Detection acknowledge switch has been disabled	Disable	pi Exp. ID	FB	Pnt #
Fire drill switch has been disabled	Disable	pi Exp. ID	FB	Pnt #
Silence switch has been disabled	Disable	pi Exp. ID	FB	Pnt #
Reset switch has been disabled	Disable	pi Exp. ID	FB	Pnt #
Constant ON Auxiliary power output has been disabled	Disable	pi Exp. ID	FB	Pnt #
Resettable auxiliary power output has been disabled	Disable	pi Exp. ID	FB	Pnt #
Door Holder auxiliary power output has been disabled	Disable	pi Exp. ID	FB	Pnt #
Manual pull switch alarm restore	Restore/Reset		FH	Zone
Detector alarm restore	Restore/Reset		FH	Zone
Fire drill has begun.	Test		FI	
Positive Alarm Sequence acknowledge switch trouble restore	Trouble		FJ	Zone
Manual pull switch trouble restore	Trouble		FJ	Zone
Detector trouble restore	Trouble		FJ	Zone
Fire drill has ended.	Test		FK	
Notification output trouble restore	Trouble		FR	1000+Grp
Aux Power Trouble Restore	Trouble		FR	0
Aux Power Trouble	Trouble		FT	0

Table 9-3: SIA Dialer Output

Event Description	Event Family	Module ID# (if any)	SIA Event Code	Parameter (if any)
Manual pull switch trouble	Trouble		FT	Zone
Detector trouble	Trouble		FT	Zone
Positive Alarm Sequence acknowledge switch trouble	Trouble		FT	Zone
Notification output trouble	Trouble		FT	1000+Grp
Notification output has been reenabled	Disable	pi Exp. ID	FU	Pnt #
Manual pull switch has been reenabled	Disable	pi Exp. ID	FU	Pnt #
Conventional detector input has been re-enabled	Disable	pi Exp. ID	FU	Pnt #
Addressable photoelectric detector has been re-enabled	Disable	pi Exp. ID	FU	Pnt #
Addressable heat detector has been re-enabled	Disable	pi Exp. ID	FU	Pnt #
Addressable ionization detector has been re-enabled	Disable	pi Exp. ID	FU	Pnt #
Addressable beam detector has been re-enabled.	Disable	pi Exp. ID	FU	Pnt #
Positive alarm sequence acknowledge switch has been re-enabled.	Disable	pi Exp. ID	FU	Pnt #
A detection acknowledge switch has been re-enabled.	Disable	pi Exp. ID	FU	Pnt #
A fire drill switch has been re-enabled.	Disable	pi Exp. ID	FU	Pnt #
A silence switch has been re-enabled.	Disable	pi Exp. ID	FU	Pnt #
A reset switch has been re-enabled	Disable	pi Exp. ID	FU	Pnt #
A constant on auxiliary power output has been re-enabled.	Disable	pi Exp. ID	FU	Pnt #
A resettable auxiliary power output has been re-enabled.	Disable	pi Exp. ID	FU	Pnt #
A door holder auxiliary power output has been re-enabled.	Disable	pi Exp. ID	FU	Pnt #
Panel date has been changed.	Trouble		JD	
Panel time has been changed.	Trouble		JT	
Local programming begin.	Trouble		LB	
Phone line trouble restore	Trouble		LR	Line #
Local programming ended normally.	Trouble		LS	
Phone line trouble detected	Trouble		LT	Line #
Local programming aborted or ended with errors.	Trouble		LU	
User initiated a system reset	Restore/Reset		OR	
Remote programming begin.	Trouble		RB	
Periodic test event.	Test		RP	Channel #
Initial Power Up.	Trouble		RR	
Remote programming ended normally.	Trouble		RS	
Unable to report to an account	Trouble		RT	Acct #
Remote programming aborted or ended with errors.	Trouble		RU	
User has initiated dialer test.	Test		RX	Channel #
Water flow switch alarm.	Alarm		SA	Zone
Water flow switch disabled	Disable	pi Exp. ID	SB	Pnt #
Supervisory/Tamper switch input has been disabled	Disable	pi Exp. ID	SB	Pnt #
Water flow switch alarm restore	Restore/Reset		SH	Zone
Supervisory/Tamper switch trouble restore	Trouble		SJ	Zone

Table 9-3: SIA Dialer Output

Event Description	Event Family	Module ID# (if any)	SIA Event Code	Parameter (if any)
Water flow switch trouble restore	Trouble		SJ	Zone
Supervisory restore	Trouble		SR	Zone
Supervisory condition	Trouble		SS	Zone
Supervisory/Tamper switch trouble	Trouble		ST	Zone
Water flow switch trouble	Trouble		ST	Zone
Water flow switch has been re-enabled.	Disable	pi Exp. ID	SU	Pnt #
Supervisory/Tamper switch input has been re-enabled.	Disable	pi Exp. ID	SU	Pnt #
Walk test end.	Test		TE	
SLC address programming ended; system has been re-enabled.	Test		TE	
Walk test begin.	Test		TS	
SLC address programming started; system has been shut down.	Test		TS	
Zone based, AUX1 switch alarm.	Alarm		UA	1000+Zone
Zone based, AUX2 switch alarm.	Alarm		UA	2000+Zone
System-based AUX1 switch alarm.	Alarm		UA	1000
System-based AUX2 switch alarm.	Alarm		UA	2000
Zone-based AUX1 switch input has been disabled	Disable	pi Exp. ID	UB	Pnt #
Zone-based AUX2 switch input has been disabled	Disable	pi Exp. ID	UB	Pnt #
System based AUX 1 switch input disabled	Disable	pi Exp. ID	UB	Pnt #
System-based AUX2 switch input disabled	Disable	pi Exp. ID	UB	Pnt #
Zone based, AUX1 switch alarm restore	Restore/Reset		UH	1000+Zone
Zone based, AUX2 switch alarm restore	Restore/Reset		UH	2000+Zone
System-based AUX1 switch alarm restore	Restore/Reset		UH	1000
System-based AUX2 switch alarm restore	Restore/Reset		UH	2000
Zone based, AUX 1 switch trouble restore	Trouble		UJ	1000+Zone
Zone based, AUX 2 switch trouble restore	Trouble		UJ	2000+Zone
System-based AUX1 switch trouble restore	Trouble		UJ	1000
System-based AUX2 switch trouble restore	Trouble		UJ	2000
External Reset/Silence Fire Drill trouble restore	Trouble		UJ	0
Zone-based Aux 1 switch trouble	Trouble		UT	1000+Zone
Zone-based Aux 2 switch trouble	Trouble		UT	2000+Zone
System-based AUX1 switch trouble	Trouble		UT	1000
System based AUX 2 switch trouble	Trouble		UT	2000
External Reset/Silence/Fire Drill switch trouble	Trouble		UT	0
Zone-based AUX 1 switch input has been re-enabled.	Disable	pi Exp. ID	UU	Pnt #
Zone-based AUX 2 switch input has been re-enabled.	Disable	pi Exp. ID	UU	Pnt #
A system-based AUX 1 switch input has been re-enabled.	Disable	pi Exp. ID	UU	Pnt #
A system-based AUX 2 switch input has been re-enabled.	Disable	pi Exp. ID	UU	Pnt #
Printer paper restored.	Trouble		VI	
Printer is out of paper.	Trouble		VO	
Printer back online.	Trouble		VY	

Table 9-3: SIA Dialer Output

Event Description	Event Family	Module ID# (if any)	SIA Event Code	Parameter (if any)
Printer offline.	Trouble		VZ	
An unexpected SLC device has been detected.	Trouble	pi Exp. ID	XE	Pnt #
An unexpected SLC device has been removed.	Trouble	pi Exp. ID	XI	Pnt #
Auto Dialer Test Communication Trouble	Trouble		YC	Line #
Checksum error.	Trouble		YF	
Auto dialer Test Communication Trouble Restore	Trouble		YK	Line #
Report to an account successful	Trouble		YK	Acct #
Ground fault condition detected	Trouble		YP	Exp. ID
Ground fault condition restore	Trouble		YQ	Exp. ID
Battery voltage restore	Trouble		YR	Exp. ID
Battery voltage low	Trouble		YT	Exp. ID

Section 10

Testing and Troubleshooting

10.1 Troubleshooting

This section of the manual offers suggestions for troubleshooting hardware problems. Please read this section if you encounter a problem when installing the control panel. If these suggestions do not solve your problem or if you encounter a problem that is not listed here, contact Silent Knight Technical Support at 800-328-0103 for assistance.

10.2 Common Problems

Problem	Possible Cause / Suggested Actions
Trouble message "DBL ADDR" (Double Address) displays on LCD.	An address has been assigned to more than one detector. Correct the address following the procedure described in Section 5.10.
Auxiliary power or notification circuits have incorrect polarity.	Correct polarity. For notification and auxiliary power circuits: When in alarm or powered, terminals labeled "X" are positive, terminals labeled "O" are negative.
SLC devices are not being recognized (trouble message "Missing" displays).	<p>Check hardware connections.</p> <p>If devices are physically connected, make sure wiring is correct (see Section 5.3). For the main panel, the positive side of device must be connected to terminal 34; the negative side must be connected to Terminal 33. For 5815XL devices, make sure the device connects to the 5815XL via the SLC OUT terminals.</p> <p>There can be only one SLC loop on the main panel and on each 5815XL module. Do not connect devices to terminals labeled SLC IN.</p>
	<p>Make sure SLC devices have been addressed properly following the procedure described in Section 5.10.</p> <p>For contact monitor modules, which are addressed using dipswitches, the dipswitch must be set to the correct address before power is applied to the SLC loop. If this procedure is not followed, the device will have an incorrect address.</p>
	<p>Make sure correct polarity has been observed for SLC device wiring. See Section 5.3.</p>

Problem	Possible Cause / Suggested Actions
<p>SLC devices are not being recognized (trouble message "Missing" displays on the annunciator).</p>	<p>Check that SLC loop impedance is within the required range. To measure impedance, use the following procedure.</p> <ol style="list-style-type: none"> 1. Disconnect both wires from the terminal block at the panel (SLC devices can remain connected). 2. Measure the impedance from positive to negative and from negative to positive. Both measurements should be greater than 500 K ohms. If the installation uses T-taps, test each T-tap individually. 3. Temporarily connect the positive wire to the negative wire of the SLC loop at the point farthest from the panel (SLC devices can remain connected). 4. Measure the impedance from positive to negative and from negative to positive. Both measurements must be less than 50 ohms.
<p>The panel indicates a ground fault trouble condition (trouble message "GROUND FAULT" displays).</p>	<p>An earth ground fault occurs when the panel senses an unexpected flow of current from one or more of its terminals to the earth connection (Terminal 2). Isolate the wiring that is causing the fault by removing wiring connections one at a time until the earth fault is no longer present. Pause at least five seconds after removing a wire before removing the next one. The panel will also go into ground fault if a computer is connected to the panel via a serial cable attached to the panel's 9-pin connector. This is a correct method for on-site communication between a panel and a computer. Ignore the ground fault message in this case. The trouble will clear automatically when you disconnect the computer from the cable</p>
<p>5815XL module that has been physically connected to the panel but is not being recognized.</p>	<p>Check the status of the 5815XL green LED. If it flashes in the pattern .5 sec on / .5 sec. off, it is likely that the 5815XL has not been added to the system through programming. JumpStart will add any 5815XLs connected to the panel. If you have already run JumpStart, 5815XLs can be added manually (see Section 4.10). Check that the correct ID for the 5815XL module has been set through the dipswitches. Assign ID#1 to the first 5815XL and ID#2 to the second 5815XL. See Section 4.10.1 for complete details. If the wiring between the 5815XL and the panel is correct, measure the voltage from 5815XL Terminal (+) to Terminal (-). Voltage should be in the range 27.2-27.4V when AC power is present. If the green LED is not flashing, the likely cause is incorrect wiring from between the 5815XL and the panel. See Section 4.6.1 for wiring details.</p>

10.2.1 Event History

The event history can be useful for tracking or recalling a trouble condition.

10.3 Built-in Troubleshooting and Testing Tools

The fire control panel has several built-in testing and troubleshooting tools that can be utilized to save time while testing and troubleshooting points and SLC devices.

10.3.1 SLC Device Locator

SLC device locator can be used to locate a device on a SLC loop.

Follow these steps to locate a particular SLC device:

1. Select 2 (Point Functions) from the Installer Menu.
2. Select 4 (SLC Dev Locator).

A message similar to the one shown in Figure 10-1 will display.

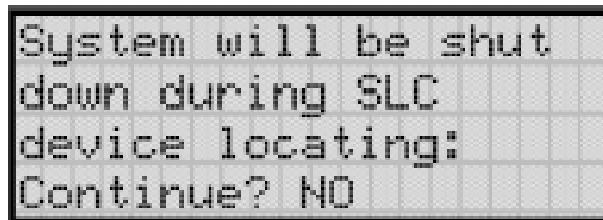


Figure 10-1 Shut Down Warning

3. Press the or arrow to toggle NO to YES then press .

If NO is chosen you will exit back to the Point Function menu.

If YES is chosen the system will cease normal operation leaving the premise unprotected.

4. Select the SLC loop.
5. Enter the SLC address of the device you wish to locate.

The LED on the selected device will start flashing.

6. Press any key to exit SLC device locator function.

Note: Once you exit the system will resume normal operation.

10.3.2 SLC Multi Locator

This feature is the same as SLC Device Locator, except you can locate up to 8 devices on a single search.

Follow these instructions to locate multiple SLC devices:

1. Select (Point Functions) from the Installer Menu.
2. Select (SLC Dev Locator).

A message similar to the one shown in Figure 10-1 will display.

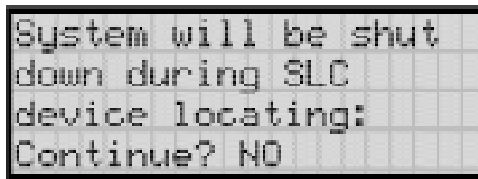


Figure 10-2 Shut Down Warning

3. Press the or arrow to toggle NO to YES then press .

If NO is chosen you will exit back to the Point Function menu.

If YES is chosen the system will cease normal operation leaving the premise unprotected.

4. Select the SLC loop.
5. Enter up to 8 SLC addresses for the devices you wish to locate.

The LEDs on the selected devices will start flashing.








6. Press the to exit SLC multi-locator function.

Note: Once you exit the system will resume normal operation.

10.3.3 I/O Point Control

This feature allows you to toggle any output on or off and trip any input device. This can be useful to test a point's output mapping.

Follow these steps to control a I/O point:

1. Select  (Point Functions) from the Installer Menu.
2. Select  (I/O Point Control).
3. Select the Module the point is on.
4. Enter the zone number , or press the  or  arrow to select the point you wish to test, then press .
5. Press  to generate an alarm for an input point or activate an output point.
6. To exit press .

Section 11

Installation Records

This section of the manual is for you to use if you wish to track of how points, zones, and groups have been programmed.

11.1 SLC Point Record

You can use the chart that begins below to keep track of SLC points.

Default addresses for ID: On-board: = 33
 5815-1: = 1
 5815-2: = 2

Table 11-1: Installation Record

Module	Addr	Zone / Group	Description	Module	Addr	Zone/ Group	Description
On-board	1			On-board	25		
On-board	2			On-board	26		
On-board	3			On-board	27		
On-board	4			On-board	28		
On-board	5			On-board	29		
On-board	6			On-board	30		
On-board	7			On-board	31		
On-board	8			On-board	32		
On-board	9			On-board	33		
On-board	10			On-board	34		
On-board	11			On-board	35		
On-board	12			On-board	36		
On-board	13			On-board	37		
On-board	14			On-board	38		
On-board	15			On-board	39		
On-board	16			On-board	40		
On-board	17			On-board	41		
On-board	18			On-board	42		
On-board	19			On-board	43		
On-board	20			On-board	44		
On-board	21			On-board	45		
On-board	22			On-board	46		
On-board	23			On-board	47		
On-board	24			On-board	48		

Table 11-1: Installation Record

Module	Addr	Zone / Group	Description	Module	Addr	Zone/ Group	Description
On-board	49			On-board	89		
On-board	50			On-board	90		
On-board	51			On-board	91		
On-board	52			On-board	92		
On-board	53			On-board	93		
On-board	54			On-board	94		
On-board	55			On-board	95		
On-board	56			On-board	96		
On-board	57			On-board	97		
On-board	58			On-board	98		
On-board	59			On-board	99		
On-board	60			On-board	100		
On-board	61			On-board	101		
On-board	62			On-board	102		
On-board	63			On-board	103		
On-board	64			On-board	104		
On-board	65			On-board	105		
On-board	66			On-board	106		
On-board	67			On-board	107		
On-board	68			On-board	108		
On-board	69			On-board	109		
On-board	70			On-board	110		
On-board	71			On-board	111		
On-board	72			On-board	112		
On-board	73			On-board	113		
On-board	74			On-board	114		
On-board	75			On-board	115		
On-board	76			On-board	116		
On-board	77			On-board	117		
On-board	78			On-board	118		
On-board	79			On-board	119		
On-board	80			On-board	120		
On-board	81			On-board	121		
On-board	82			On-board	122		
On-board	83			On-board	123		
On-board	84			On-board	124		
On-board	85			On-board	125		
On-board	86			On-board	126		
On-board	87			On-board	127		
On-board	88						

Table 11-1: Installation Record

Module	Addr	Zone / Group	Description	Module	Addr	Zone/ Group	Description
5815-1	1			5815-1	42		
5815-1	2			5815-1	43		
5815-1	3			5815-1	44		
5815-1	4			5815-1	45		
5815-1	5			5815-1	46		
5815-1	6			5815-1	47		
5815-1	7			5815-1	48		
5815-1	8			5815-1	49		
5815-1	9			5815-1	50		
5815-1	10			5815-1	51		
5815-1	11			5815-1	52		
5815-1	12			5815-1	53		
5815-1	13			5815-1	54		
5815-1	14			5815-1	55		
5815-1	15			5815-1	56		
5815-1	16			5815-1	57		
5815-1	17			5815-1	58		
5815-1	18			5815-1	59		
5815-1	19			5815-1	60		
5815-1	20			5815-1	61		
5815-1	21			5815-1	62		
5815-1	22			5815-1	63		
5815-1	23			5815-1	64		
5815-1	24			5815-1	65		
5815-1	25			5815-1	66		
5815-1	26			5815-1	67		
5815-1	27			5815-1	68		
5815-1	28			5815-1	69		
5815-1	29			5815-1	70		
5815-1	30			5815-1	71		
5815-1	31			5815-1	72		
5815-1	32			5815-1	73		
5815-1	33			5815-1	74		
5815-1	34			5815-1	75		
5815-1	35			5815-1	76		
5815-1	36			5815-1	77		
5815-1	37			5815-1	78		
5815-1	38			5815-1	79		
5815-1	39			5815-1	80		
5815-1	40			5815-1	81		
5815-1	41			5815-1	82		

Table 11-1: Installation Record

Module	Addr	Zone / Group	Description	Module	Addr	Zone/ Group	Description
5815-1	83			5815-1	123		
5815-1	84			5815-1	124		
5815-1	85			5815-1	125		
5815-1	86			5815-1	126		
5815-1	87			5815-1	127		
5815-1	88						
5815-1	89			5815-2	1		
5815-1	90			5815-2	2		
5815-1	91			5815-2	3		
5815-1	92			5815-2	4		
5815-1	93			5815-2	5		
5815-1	94			5815-2	6		
5815-1	95			5815-2	7		
5815-1	96			5815-2	8		
5815-1	97			5815-2	9		
5815-1	98			5815-2	10		
5815-1	99			5815-2	11		
5815-1	100			5815-2	12		
5815-1	101			5815-2	13		
5815-1	102			5815-2	14		
5815-1	103			5815-2	15		
5815-1	104			5815-2	16		
5815-1	105			5815-2	17		
5815-1	106			5815-2	18		
5815-1	107			5815-2	19		
5815-1	108			5815-2	20		
5815-1	109			5815-2	21		
5815-1	110			5815-2	22		
5815-1	111			5815-2	23		
5815-1	112			5815-2	24		
5815-1	113			5815-2	25		
5815-1	114			5815-2	26		
5815-1	115			5815-2	27		
5815-1	116			5815-2	28		
5815-1	117			5815-2	29		
5815-1	118			5815-2	30		
5815-1	119			5815-2	31		
5815-1	120			5815-2	32		
5815-1	121			5815-2	33		
5815-1	122			5815-2	34		

Table 11-1: Installation Record

Module	Addr	Zone / Group	Description	Module	Addr	Zone/ Group	Description
5815-2	35			5815-2	75		
5815-2	36			5815-2	76		
5815-2	37			5815-2	77		
5815-2	38			5815-2	78		
5815-2	39			5815-2	79		
5815-2	40			5815-2	80		
5815-2	41			5815-2	81		
5815-2	42			5815-2	82		
5815-2	43			5815-2	83		
5815-2	44			5815-2	84		
5815-2	45			5815-2	85		
5815-2	46			5815-2	86		
5815-2	47			5815-2	87		
5815-2	48			5815-2	88		
5815-2	49			5815-2	89		
5815-2	50			5815-2	90		
5815-2	51			5815-2	91		
5815-2	52			5815-2	92		
5815-2	53			5815-2	93		
5815-2	54			5815-2	94		
5815-2	55			5815-2	95		
5815-2	56			5815-2	96		
5815-2	57			5815-2	97		
5815-2	58			5815-2	98		
5815-2	59			5815-2	99		
5815-2	60			5815-2	100		
5815-2	61			5815-2	101		
5815-2	62			5815-2	102		
5815-2	63			5815-2	103		
5815-2	64			5815-2	104		
5815-2	65			5815-2	105		
5815-2	66			5815-2	106		
5815-2	67			5815-2	107		
5815-2	68			5815-2	108		
5815-2	69			5815-2	109		
5815-2	70			5815-2	110		
5815-2	71			5815-2	111		
5815-2	72			5815-2	112		
5815-2	73			5815-2	113		
5815-2	74			5815-2	114		

Table 11-1: Installation Record

Module	Addr	Zone / Group	Description	Module	Addr	Zone/ Group	Description
5815-2	115			5815-2	122		
5815-2	116			5815-2	123		
5815-2	117			5815-2	124		
5815-2	118			5815-2	125		
5815-2	119			5815-2	126		
5815-2	120			5815-2	127		
5815-2	121						

Copy these pages if you additional sheets.

11.2 Conventional Output Point Record

This chart can be used to keep track of how conventional output points (circuits) have been configured.

Point/Circuit	Group	Description
1		
2		
3		
4		
5		
6		
7		
8		

Appendix A

Compatible Devices

A.1 Two-Wire Smoke Detectors

The table below lists two-wire smoke detectors that are compatible with the fire control panel. The table is organized by manufacturer. The columns show the number of detectors per loop that can be used.

Table A-1: Compatible Two-Wire Smoke Detectors

Manufacturer	Model Name or Number (Base model name or number in parentheses.)	Compatibility ID		# per Loop
		Head	Base	
Apollo	55000-350 (45681-200)	55000-350	45681-200	24 / loop
	55000-250 (45681-200)	55000-250	45681-200	24 / loop
ESL	429C (S10A)	N/A	S10A	30 / loop
	429CRT (S11A)	N/A	S11A	30 / loop
	429CST (S11A)	N/A	S11A	30 / loop
	429CT (S10A)	N/A	S10A	30 / loop
	609U01-11	S10	S00	40 / loop
	609U02-11	S10	S00/S03	40 / loop
	611U (601U or 602U)	S10	S00/S03	40 / loop
	611UD (601U or 602U)	S10	S00/S03	40 / loop
	611UT (601U or 602U)	S10	S00/S03	40 / loop
	612U (601U or 602U)	S10	S00/S03	40 / loop
	612UD (601U or 602U)	S10	S00/S03	40 / loop
	711U (701E or 701U)	N/A	S10A	25 / loop
	712U (701E or 701U)	N/A	S10A	25 / loop
	713-5U (702E or 701U)	N/A	S10A	25 / loop
	713-6U (702E or 701U)	N/A	S10A	25 / loop
	721-U (S10A)	N/A	S10A	30 / loop
	721-UT (S10A)	N/A	S10A	30 / loop
Falcon	525	FDT1	N/A	17 / loop
	525T	FDT1	N/A	17 / loop
Hochiki	SIH-24F (HS-224D OR HSD-224)	HD-3	HB-5	25 / loop
	SLK-24F (HS-224D)	HD-3	HB-5	25 / loop
	SLK-24FH (HS-224D)	HD-3	HB-5	25 / loop

A.3 Notification Appliances

For proper operation, you must use polarized devices with a Model 7628 4.7k ohm EOL resistor on each loop. All supervised notification appliances used with the control panel must be polarized.

The chart below lists notification appliances compatible with the 5395.

Manufacturer	Model	Type
Faraday	446	Vibrating Bell
Faraday	476	Vibrating Bell
Faraday	477	Single Stroke Bell
Faraday	5333	Multi-Tone Horn)
Faraday	5336	Multi-Tone Horn/Strobe
Faraday	5337	Multi-Tone Horn/Strobe
Faraday	5338	Multi-Tone Horn/Strobe
Faraday	5343	Single Tone Horn/Strobe
Faraday	5346	Electronic Horn with Strobe
Faraday	5347	Electronic Horn with Strobe
Faraday	5348	Single Tone Horn/Strobe
Faraday	5373	8-Tone Horn/Strobe
Faraday	5376	8-Tone Horn/Strobe
Faraday	5377	8-Tone Horn/Strobe
Faraday	5378	8-Tone Horn/Strobe
Faraday	5383	8-Tone Horn/Strobe with Sync Strobe
Faraday	5386	8-Tone Horn/Strobe with Sync Strobe
Faraday	5387	8-Tone Horn/Strobe with Sync Strobe
Faraday	5388	8-Tone Horn/Strobe with Sync Strobe
Faraday	5405	Sync Control Unit
Faraday	5508	Single Gang Sync Strobe
Faraday	5509	Strobe
Faraday	5510	Strobe
Faraday	5511	Strobe
Faraday	5512	Strobe
Faraday	5516	Strobe
Faraday	5517	Strobe
Faraday	5518	Strobe
Faraday	5519	Strobe
Faraday	5521	4" Square Sync Strobe
Faraday	5522	4" Square Sync Strobe
Faraday	6120	Horn
Faraday	6140	Horn

Manufacturer	Model	Type
Faraday	6223	Horn
Faraday	6226	Horn/Strobe
Faraday	6227	Horn/Strobe
Faraday	6228	Horn/Strobe
Faraday	6243	Electron-Mechanical Horn
Faraday	6244	Electron-Mechanical Horn
Faraday	6245	Electron-Mechanical Horn
Faraday	6246	Electron-Mechanical Horn/Strobe
Faraday	6247	Electron-Mechanical Horn/Strobe
Faraday	6248	Electron-Mechanical Horn/Strobe
Faraday	6300	Mini-Horn
Faraday	6301	Mini-Horn
Faraday	6302	Mini-Horn
Faraday	6310	Mini-Horn/Strobe/Strobe
Faraday	6311	Mini-Horn/Strobe/Strobe
Faraday	6312	Mini-Horn/Strobe/Strobe
Faraday	6320	Sync Mini Horn/Strobe
Faraday	6321	Sync Mini Horn/Strobe
Faraday	6322	Mini Horn/Sync Strobe
Faraday	6380	8-Tone Electronic Signal
Federal Signal	450	Horn
Federal Signal	VALS	Horn/Strobe
Gentex	GOS-24-15-1WR	Multi-Tone Horn Strobe
Gentex	GOS-24-15-1WW	Multi-Tone Horn Strobe
Gentex	GOS-24-15-1PWR	Multi-Tone Horn Strobe
Gentex	GOS-24-15-1PWW	Multi-Tone Horn Strobe
Gentex	GOS-24-110-1WR	Multi-Tone Horn Strobe
Gentex	GOS-24-110-1WW	Multi-Tone Horn Strobe
Gentex	GOS-24-110-PWR	Multi-Tone Horn Strobe
Gentex	GOS-24-110-PWW	Multi-Tone Horn Strobe
Gentex	GOS-24-1575WR	Multi-Tone Horn Strobe
Gentex	GOS-24-1575WW	Multi-Tone Horn Strobe
Gentex	GOS-24-1575CR	Multi-Tone Horn Strobe
Gentex	GOS-24-1575CW	Multi-Tone Horn Strobe
Gentex	GOS-24-1575PWR	Multi-Tone Horn Strobe
Gentex	GOS-24-1575PWW	Multi-Tone Horn Strobe
Gentex	GOS-24-1575PCR	Multi-Tone Horn Strobe
Gentex	GOS-24-1575PCW	Multi-Tone Horn Strobe
Gentex	GOS-24-3075WR	Multi-Tone Horn Strobe

Manufacturer	Model	Type
Gentex	GOS-24-3075WW	Multi-Tone Horn Strobe
Gentex	GOS-24-3075PWR	Multi-Tone Horn Strobe
Gentex	GOS-24-3075PWW	Multi-Tone Horn Strobe
Gentex	GOT-24R	Multi-Tone Horn
Gentex	GOT-24W	Multi-Tone Horn
Gentex	GMH24R	Electro-Mechanical Horn
Gentex	GMS24-110-1WR	Electro-Mechanical Horn Strobe
Gentex	GMS24-110-PWR	Electro-Mechanical Horn Strobe
Gentex	GMS24-15-1WR	Electro-Mechanical Horn Strobe
Gentex	GMS24-1575WR	Electro-Mechanical Horn Strobe
Gentex	GMS24-1575CR	Electro-Mechanical Horn Strobe
Gentex	GMS24-1575PWR	Electro-Mechanical Horn Strobe
Gentex	GMS24-1575PCR	Electro-Mechanical Horn Strobe
Gentex	GX90-4R	Mini Horn
Gentex	GX90-4B	Mini Horn
Gentex	GX90S-4-15-1WR	Mini Horn w/Strobe
Gentex	GX90S-4-15-1WB	Mini Horn w/Strobe
Gentex	GX90S-4-15-1PWR	Mini Horn w/Strobe
Gentex	GX90S-4-15-1PWB	Mini Horn w/Strobe
Gentex	GX90S-4-110-1WR	Mini Horn w/Strobe
Gentex	GX90S-4-110-1WB	Mini Horn w/Strobe
Gentex	GX90S-4-110-1PWR	Mini Horn w/Strobe
Gentex	GX90S-4-110-1PWB	Mini Horn w/Strobe
Gentex	GX90S-4-1575-WR	Mini Horn w/Strobe
Gentex	GX90S-4-1575WB	Mini Horn w/Strobe
Gentex	GX90S-4-1575CR	Mini Horn w/Strobe
Gentex	GX90S-4-1575CB	Mini Horn w/Strobe
Gentex	GX90S-4-1575PWR	Mini Horn w/Strobe
Gentex	GX90S-4-1575-PWB	Mini Horn w/Strobe
Gentex	GXS-4-15-1WR	Visual Strobe
Gentex	GXS-4-15-1WB	Visual Strobe
Gentex	GXS-4-15-1PWR	Visual Strobe
Gentex	GXS-4-15-1PWB	Visual Strobe
Gentex	GXS-4-110-1WR	Visual Strobe
Gentex	GXS-4-110-1WB	Visual Strobe
Gentex	GXS-4-110-1PWR	Visual Strobe
Gentex	GXS-4-110-1PWB	Visual Strobe
Gentex	GXS-4-1575WR	Visual Strobe
Gentex	GXS-4-1575WB	Visual Strobe

Manufacturer	Model	Type
Gentex	GXS-4-1575CR	Visual Strobe
Gentex	GXS-4-1575CB	Visual Strobe
Gentex	GXS-4-1575PWR	Visual Strobe
Gentex	GXS-4-1575PWB	Visual Strobe
Gentex	HG124R	Mini Horn w/Strobe
Gentex	HG124B	Mini Horn w/Strobe
Gentex	SHG24-15-1WR	Mini Horn w/Strobe
Gentex	SHG24-15-1WB	Mini Horn w/Strobe
Gentex	SHG24-15-1PWR	Mini Horn w/Strobe
Gentex	SHG24-15-1PWB	Mini Horn w/Strobe
Gentex	SHG24-110-1WR	Mini Horn w/Strobe
Gentex	SHG24-110-1WB	Mini Horn w/Strobe
Gentex	SHG24-110-1PWR	Mini Horn w/Strobe
Gentex	SHG24-110-1PWB	Mini Horn w/Strobe
Gentex	SHG24-1575WR	Mini Horn w/Strobe
Gentex	SHG24-1575WB	Mini Horn w/Strobe
Gentex	SHG24-1575CR	Mini Horn w/Strobe
Gentex	SHG24-1575CB	Mini Horn w/Strobe
Gentex	SHG24-1575PWR	Mini Horn w/Strobe
Gentex	SHG24-1575PWB	Mini Horn w/Strobe
System Sensor	MASS241	Horn/Strobe
System Sensor	MASS24110ADA	Horn/Strobe
System Sensor	MASS2415ADA	Horn/Strobe
System Sensor	MASS2475ADA	Horn/Strobe
System Sensor	SS24110ADA	Strobe
System Sensor	SS2415ADA	Strobe
System Sensor	SS2475ADA	Strobe
System Sensor	PS2415ADA	Mini-Horn/Strobe
System Sensor	PS241575ADA	Mini-Horn/Strobe
System Sensor	PS24110ADA	Mini-Horn/Strobe
System Sensor	PS2475ADA	Mini-Horn/Strobe
Wheelock	46T-G4-24-R	Bell
Wheelock	46T-G6-24-R	Bell
Wheelock	46T-G10-24-R	Bell
Wheelock	46T-G6-24-WS-24-HF-R	Strobe/Bell
Wheelock	46T-G10-24-WS-24-HF-R	Strobe/Bell
Wheelock	46T-G6-24-WH-24-HF-R	Strobe/Bell
Wheelock	46T-G10-24-WH-24-HF-R	Strobe/Bell
Wheelock	700IT-12\24-W-FR	Strobe Horn

Manufacturer	Model	Type
Wheelock	7002T-12\24-W-FR	Strobe Horn
Wheelock	AES-DL1-R	Multitone Horn
Wheelock	AES-EL1-R	Multitone Horn
Wheelock	AES-DL1-WS-24-VF-R	Multitone Horn
Wheelock	AES-EL1-WS-24-VF-R	Multitone Horn
Wheelock	AES-DL1-WH-24-VF-R	Multitone Horn
Wheelock	AES-EL1-WH-24-VF-R	Multitone Horn
Wheelock	AES-DL1-WM-24-VF-R	Multitone Horn
Wheelock	AES-EL1-WM-24-VF-R	Multitone Horn
Wheelock	AH-24-R	Horn
Wheelock	AMT-12\24-R	Strobe Horn
Wheelock	AMT-24-LS-VFR	Strobe Horn
Wheelock	AMT-24-LSM-VFR	Strobe Horn
Wheelock	AMT-24-IS-VFR	Strobe Horn
Wheelock	AS-2415-VFR	Strobe Horn
Wheelock	AS-241575-VFR	Strobe Horn
Wheelock	AS-2430-VFR	Strobe Horn
Wheelock	AS-2475-VFR	Strobe Horn
Wheelock	AS-24110-HFR	Strobe Horn
Wheelock	SM-12\24-R	Strobe Horn Controller
Wheelock	DSM-12\24-R	Strobe Horn Controller
Wheelock	CF-BF1	Chime
Wheelock	CF-BF1-R	Chime
Wheelock	CH-CF1	Chime
Wheelock	CH-CF1-R	Chime
Wheelock	CH-CF1-W	Chime
Wheelock	CH-DF1	Chime
Wheelock	CH-DF1-R	Chime
Wheelock	CH-BF1-WS-24-HF-R	Strobe Chime
Wheelock	CH-CF1-LS-24	Strobe Chime
Wheelock	CH-CF1-MS-24	Strobe Chime
Wheelock	CH-CF1-IS-24	Strobe Chime
Wheelock	CH-CF1-LS-24-CFW	Strobe Chime
Wheelock	CH-CF1-MS-24-CFW	Strobe Chime
Wheelock	CH-CF1-IS-24-CFW	Strobe Chime
Wheelock	CH-CF1-WS-24-CF-W	Strobe Chime
Wheelock	CH-DF1-LS-24	Strobe Chime
Wheelock	CH-DF1-MS-24	Strobe Chime
Wheelock	CH-DF1-IS-24	Strobe Chime

Manufacturer	Model	Type
Wheelock	CH-DF1-LS-24-VFR	Strobe Chime
Wheelock	CH-DF1-LSM-24-VFR	Strobe Chime
Wheelock	CH-DF1-MS-24-VFR	Strobe Chime
Wheelock	CH-DF1-IS-24-VFR	Strobe Chime
Wheelock	CH-DF1-WM-24-VFR	Strobe Chime
Wheelock	CH-DF1-WS-24-VF-R	Strobe Chime
Wheelock	DSM-12/24	Sync Module
Wheelock	EH-DL1-R	Electronic Horn
Wheelock	EH-EL1-R Electronic Horn	Electronic Horn
Wheelock	EHS-DL1-W-VF-R	Strobe Horn (single input)
Wheelock	EHS-EL1-W-VF-R	Strobe Horn (single input)
Wheelock	EH-DL1-WS-24-VF-R	Strobe Horn (dual input)
Wheelock	EH-EL1-WS-24-VF-R	Strobe Horn (dual input)
Wheelock	EH-DL1-WH-24-VF-R	Strobe Horn (dual input)
Wheelock	EH-EL1-WH-24-VF-R	Strobe Horn (dual input)
Wheelock	EH-DL1-WM-24-VF-R	Strobe Horn (dual input)
Wheelock	EH-EL1-WM-24-VF-R	Strobe Horn (dual input)
Wheelock	HSW-24-HFR	Remote Strobe
Wheelock	HS2W-24-HFR	Remote Strobe
Wheelock	HSPW-24-HFR	Remote Strobe
Wheelock	IS-24-VFR	Remote Strobe
Wheelock	IS1-24-VFR	Remote Strobe
Wheelock	IS3-24-VFR	Remote Strobe
Wheelock	ISP-24-HFR	Remote Strobe
Wheelock	LS-24-VFR	Remote Strobe
Wheelock	LS1-24-VFR	Remote Strobe
Wheelock	LS3-24-VFR	Remote Strobe
Wheelock	LSP-24-HFR	Remote Strobe
Wheelock	LSM-24-VFR	Remote Strobe
Wheelock	LS1M-24-VFR	Remote Strobe
Wheelock	LS3M-24-VFR	Remote Strobe
Wheelock	LSPM-24-VFR	Remote Strobe
Wheelock	MS-24-VFR	Remote Strobe
Wheelock	MS1-24-VFR	Remote Strobe
Wheelock	MS3-24-VFR	Remote Strobe
Wheelock	MSP-24-HFR	Remote Strobe
Wheelock	MB-G6-24-R	Motor Bell
Wheelock	MB-G10-24-R	Motor Bell
Wheelock	MBS-G6-24-W-HF-R	Motor Bell with Strobe

Manufacturer	Model	Type
Wheelock	MBS-G10-24-W-HF-R	Motor Bell with Strobe
Wheelock	MIZ-24-R	Mini-Horn
Wheelock	MIZ-24-W	Mini-Horn
Wheelock	MIZ-24-LS-VFR	Mini-Horn/Strobe
Wheelock	MIZ-24-LSM-VFR	Mini-Horn/Strobe
Wheelock	MIZ-24-MS-VFR	Mini-Horn/Strobe
Wheelock	MIZ-24-HSW-HFR	Mini-Horn/Strobe
Wheelock	MIZ-24-IS-VFR	Mini-Horn/Strobe
Wheelock	MIZ-24-WS-VF-R	Mini-Horn/Strobe
Wheelock	MIZ-24-WS-VF-W	Mini-Horn/Strobe
Wheelock	MIZ-24-WH-VF-W	Mini-Horn/Strobe
Wheelock	MIZ-24-WM-VF-W	Mini-Horn/Strobe
Wheelock	MT-12/24-R	Strobe Horn
Wheelock	MT-24-LS-VFR	Strobe Horn
Wheelock	MT-24-LSM-VFR	Strobe Horn
Wheelock	MT-24-MS-VFR	Strobe Horn
Wheelock	MT-24-IS-VFR	Strobe Horn
Wheelock	MT-24-SL-VFR	Strobe Horn
Wheelock	MT-24-SLM-VFR	Synch. Multitone Strobe
Wheelock	MT-24-WM	Strobe
Wheelock	MT-24-WM-VFR	Horn
Wheelock	RS-2415-HFR	Strobe
Wheelock	RSP-2415-VFR	Strobe
Wheelock	RS-241575-VFR	Strobe
Wheelock	RSP-241575-VFR	Strobe
Wheelock	RS-2430-VFR	Strobe
Wheelock	RS-2430-HFR	Strobe
Wheelock	RS-2475-VFR	Strobe
Wheelock	RSP-2475-HFR	Strobe
Wheelock	RS-24110-HFR	Strobe
Wheelock	RSP-24110-HFR	Strobe
Wheelock	SL-24-VFR	Synchronized Remote Strobe
Wheelock	SL1-24-VFR	Synchronized Remote Strobe
Wheelock	SL3-24-VFR	Synchronized Remote Strobe
Wheelock	SLP-24-VFR	Synchronized Remote Strobe
Wheelock	SLM-24-VFR	Synchronized Remote Strobe
Wheelock	SL1M-24-VFR	Synchronized Remote Strobe
Wheelock	SL3M-24-VFR	Synchronized Remote Strobe
Wheelock	SLPM-24-VFR	Synchronized Remote Strobe

Manufacturer	Model	Type
Wheelock	SHW-24-VFR	Synchronized Remote Strobe
Wheelock	SH2W-24-VFR	Synchronized Remote Strobe
Wheelock	SHPW-24-VFR	Synchronized Remote Strobe
Wheelock	SCM-24-R	Controller for Synchronized Strobes
Wheelock	SM-12/24-R	Sync Module
Wheelock	SR-2415-VFR	Sync Strobe
Wheelock	SRP-2415-HFR	Sync Strobe
Wheelock	SR-241575-VFR	Sync Strobe
Wheelock	SRP-241575-VFR	Sync Strobe
Wheelock	SR-2475-VFR	Sync Strobe
Wheelock	SR-2475-HFR	Sync Strobe
Wheelock	SR-24110-HFR	Sync Strobe
Wheelock	SRP-24110-HFR	Sync Strobe
Wheelock	V700IT-12\24-W-FR	Strobe Horn
Wheelock	WM3T-24-FR	Remote Strobe
Wheelock	WM3T-24-VFR	Remote Strobe
Wheelock	WSIT-24-FR	Strobe
Wheelock	WS3T-24-FR	Strobe
Wheelock	WST-24-FR	Strobe

A.4 Door Holder Device

The following UL listed door holder can be used with the control panel: ESL DHS-1224

Appendix B

Word and Special Characters Lists

This section contains tables of programmable words or special characters that may be used for device, module, and zone names or phone numbers.

B.1 Name Library

The control panel has a built-in library (or list) of 120 9-character words that are available for you to select for naming points, zones, and groups. You can add up to 136 of your own 9-character words to the library which will then be available to select (see Table B-2).

Table B-1: Description Name Library

Word#	Text	Word#	Text	Word#	Text	Word#	Text
W000	(blank)	W031	DISASTER	W062	LOWER	W093	SOUNDER
W001	1ST	W032	DOCK	W063	MAIN	W094	SOUTH
W002	2ND	W033	DOOR	W064	MAN_PULL	W095	SPRINKLER
W003	3RD	W034	DRILL	W065	MANUFACT	W096	STAIRWAY
W004	4TH	W035	DUCT	W066	MIDDLE	W097	STORE_RM
W005	ACKNOWLEDG	W036	EAST	W067	MODULE	W098	STROBE
W006	ACTIVE	W037	ELEC_RM	W068	MONITOR	W099	SUPERVSY
W007	ALARM	W038	ELEVATOR	W069	NORTH	W100	SWITCH
W008	ALERT	W039	EMERGENCY	W070	NOTIF	W101	SYS_AUX1
W009	AUX_PWR	W040	ENTRANCE	W071	OFFICE	W102	SYS_AUX2
W010	AUXILIARY	W041	EVACUATE	W072	PAS_ACK	W103	SYSTEM
W011	BACK	W042	FAULT	W073	PATIENT	W104	TAMPER
W012	BASEMENT	W043	FIRE	W074	PHONE	W105	TEST
W013	BATTERY	W044	FIREDRILL	W075	PHOTO	W106	TORNADO
W014	BEAM	W045	FLOOR	W076	POINT	W107	TROUBLE
W015	BELL_CKT	W046	FLR	W077	PREALARM	W108	UNIT
W016	BOILER_RM	W047	FRONT	W078	PULLSTA	W109	UNUSED
W017	CAFE	W048	GARAGE	W079	REAR	W110	UPPER
W018	CENTER	W049	GAS	W080	RELAY	W111	VALVE
W019	CIRCUIT	W050	GROUP	W081	REMOTE	W112	WARNING
W020	CKT	W051	HALL	W082	RESET	W113	WATERFLOW
W021	CLASS_RM	W052	HAZARD	W083	RESTAURNT	W114	WEST
W022	COMBO	W053	HEAT	W084	RESETABLE	W115	WHSE
W023	COMPUTER	W054	HOOD	W085	RESTROOM	W116	WING
W024	CONSTANT	W055	HORN_CKT	W086	RM	W117	ZONE
W025	CONFRNCE	W056	HVAC	W087	ROOM	W118	ZN_AUX1
W026	CONTROL	W057	ION	W088	SAFE	W119	ZN_AUX2
W027	CONVENT	W058	KITCHEN	W089	SECURITY		
W028	CORRIDOR	W059	LEVEL	W090	SHIPPING		
W029	DAMPER	W060	LOBBY	W091	SILENCE		
W030	DETECTOR	W061	LOCAL	W092	SMOKE		

B.2 Characters For Customized Textual Descriptions

Table B-2: Alphanumeric Characters Used for Textual Descriptions

Character	Description
A-Z	UPPER-case letters
a-z	lower-case letters
[Blank]	Blank space to use between words and so on.
0-9	Numbers can also be entered directly from the annunciator.
:	colon
-	dash
_	underbar, looks like a blank character when it is being selected
.	period
,	comma
&	ampersand
*	asterisk
#	pound or number sign

Silent Knight Fire Product Warranty and Return Policy

General Terms and Conditions

- All new fire products manufactured by Silent Knight after September 1, 1997 have a limited warranty period of 18 months from the date of manufacture against defects in materials and workmanship. See limited warranty statement for details.
- This limited warranty does not apply to those products that are damaged due to misuse, abuse, negligence, or have been modified in any manner whatsoever.

Repair and RA Procedure

- All products that are returned to Silent Knight for credit or repair require a RA (Return Authorization) number. Call Silent Knight Customer Service at 800-446-6444 or 612-493-6435 between 8:00 A.M. and 5:00 P.M. CST, Monday through Friday to obtain a return authorization number. Silent Knight Technical Support is available at 800-328-0103 between 8:00 A.M. and 6:00 P.M. CST, Monday through Friday.
- RA number must be prominently displayed on the outside of the shipping box. See return address example under Advanced Replacement Policy.
- All products returned to Silent Knight must be sent freight pre-paid. After product is processed, Silent Knight will pay for shipping product back to customer.
- Return the Silent Knight product circuit board only. Products that are returned in cabinets will be charged an additional \$20 to cover the extra shipping and handling costs over board only returns. Do not return batteries. Silent Knight has the authority to determine if a product is repairable. Products that are deemed un-repairable will be returned to the customer.
- Product that is returned that has a board date code more than 18 months from date of manufacture will be repaired and the customer will be assessed the standard Silent Knight repair charge for that model.
- A detailed description of the problem should be included with each return.

Advanced Replacement Policy

- Silent Knight offers an option of advance replacement for fire product printed circuit boards that fail during the 18 month warranty period.
- For advance replacement of a defective board call Silent Knight at 800-446-6444 or 612-493-6435 to obtain a RA (Return Authorization) number and request advanced replacement.
- Customers must use a MasterCard or Visa credit card to get an advance replacement.

- A new or refurbished board will be shipped to the customer. The customer will initially be billed for the replacement board but a credit will be issued after the repairable board is received at Silent Knight.
- The defective board must be returned within 30 days of shipment of replacement board for customer to receive credit. No credit will be issued if the returned board was damaged due to misuse or abuse.
- Repairs and returns should be sent to:

Silent Knight

Attn: Repair Department

7550 Meridian Circle

Maple Grove, MN 55369-4927

RA Number:_____

Limited Warranty

Silent Knight warrants that the products of its manufacture shall be free from defects in materials or workmanship for 18 months from the manufacturing date code on the printed circuit board, if such goods have been properly installed, are subject to normal proper use, and have not been modified in any manner whatsoever. Upon return of the defective product, Silent Knight will, at its sole discretion, either repair or replace, at no cost, such goods as may be of defective material or workmanship. Customers outside the United States are to return products to their distributor for repair.

SILENT KNIGHT SHALL NOT UNDER ANY CIRCUMSTANCES BE LIABLE FOR ANY INCIDENTAL OR CONSEQUENTIAL DAMAGES ARISING FROM LOSS OF PROPERTY OR OTHER DAMAGE OR LOSSES OWING TO THE FAILURE OF SILENT KNIGHT SECURITY SYSTEMS PRODUCTS BEYOND THE COST OF REPAIR OR REPLACEMENT OF ANY DEFECTIVE PRODUCTS.

SILENT KNIGHT MAKES NO WARRANTY OF FITNESS OR MERCHANTABILITY AND NO OTHER WARRANTY, ORAL OR WRITTEN, EXPRESS OR IMPLIED, BEYOND THE 18 MONTH WARRANTY EXPRESSLY SPECIFIED HEREIN.