

# **INSTALLATION/PROGRAMMING INSTRUCTIONS**



## **AVENGER VIII ALARM SYSTEM**



**MODEL AV-8000F**

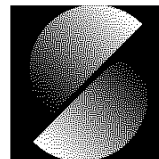

**SENTROL**

**CORPORATE HEADQUARTERS**

12345 SW Leveton Dr., Tualatin, OR 97062

Tel.: 503.692.4052 Fax: 503.691.7566

<http://www.sentrol.com>

**U.S. & Canada: 800.547.2556**

**Technical Service: 800.648.7424**

**FaxBack: 800.483.2495**

# TABLE OF CONTENTS

<b>SECTION I: INSTALLATION INSTRUCTIONS</b> .....	<b>1-7</b>
1.0 SYSTEM DESCRIPTION .....	1
1.1 INSTALLATION .....	1-3
1.2 TROUBLESHOOTING .....	3
1.3 ADDITIONAL NOTES .....	3
1.4 FIGURE 1 - WIRING DIAGRAM FOR MODEL AV-8000F .....	4
1.5 SPECIFICATIONS .....	5
1.6 OPTIONAL ACCESSORIES .....	5
1.7 FCC COMPLIANCE .....	6
1.8 CANADIAN INSTALLATIONS .....	6
1.9 U.L. COMPLIANCE/VERIFICATION .....	7
HARDWARE CONSIDERATIONS .....	7
PROGRAMMING CONSIDERATIONS .....	7
1.10 CALIFORNIA STATE FIRE MARSHALL INSTALLATION CONSIDERATIONS .....	7
<b>SECTION II: PROGRAMMING INSTRUCTIONS</b> .....	<b>8-16</b>
<b>GENERAL</b> .....	<b>8</b>
2.0 INTRODUCTION .....	8
2.1 PROGRAMMING MODE .....	8
<b>DISPLAY</b> .....	<b>8-9</b>
2.2 LED ARRANGEMENT .....	8-9
2.3 NUMERIC DATA .....	9
2.4 SELECTION DATA .....	9
<b>KEYPAD</b> .....	<b>9-10</b>
2.5 CHANGING MEMORY LOCATIONS AND VIEWING DATA .....	9
2.6 PROGRAMMING NUMERIC DATA .....	10
2.7 REVIEWING THE DATA .....	10
2.8 REPROGRAMMING NUMERIC DATA .....	10
2.9 PROGRAMMING SELECTION DATA .....	10
<b>SUMMARY</b> .....	<b>11</b>
2.10 MODE KEY .....	11
2.11 ENTER KEY .....	11
2.12 NUMERIC KEYS .....	11
<b>EXAMPLES AND FIGURES</b> .....	<b>11-16</b>
2.13 PROGRAMMING EXAMPLE .....	11
2.14 PROGRAMMING WORKSHEET EXAMPLE - FIGURE 2 .....	12-13
2.15 RECEIVER FORMAT EXAMPLE - FIGURE 3 .....	14
2.16 PROGRAMMING WORKSHEET - FIGURE 4 .....	15-16
<b>SECTION III: PROGRAMMING INSTRUCTIONS - DEFINITIONS</b> .....	<b>17-23</b>
3.0 TELEPHONE NUMBERS .....	17
3.1 FIRST NUMBER DIALING .....	17
3.2 SECOND NUMBER DIALING .....	17
3.3 FIRST ACCOUNT NUMBER .....	17
3.4 SECOND ACCOUNT NUMBER .....	18
3.5 DIAL SECOND NUMBER ONLY, SELECT ZONES .....	18
3.6 DIAL BOTH NUMBERS, SELECT ZONES .....	18
3.7 ROTARY/TOUCH TONE DIALING .....	18
3.8 MANUAL SMOKE RESET .....	18
3.9 FALSE ALARM SHUT DOWN (SWINGER REJECTION) .....	18
3.10 EUROPEAN MAKE/BREAK .....	18
3.11 DK-III OR DK-II OPERATION .....	18

# TABLE OF CONTENTS

<b>SECTION III: PROGRAMMING INSTRUCTIONS - DEFINITIONS (continued)</b>		<b>17-23</b>
3.12	DUAL BELL OPERATION	18
3.13	INHIBIT FAILURE TO COMMUNICATE	18
3.14	RECEIVER FORMATS FOR THE FIRST TELEPHONE NUMBER	19
3.15	RECEIVER FORMATS FOR THE SECOND TELEPHONE NUMBER	19
3.16	RESTORE, SELECT ZONES	19
3.17	RESTORE CODE	19
3.18	TEST CANCEL, SELECT ZONES	19
3.19	TEST CANCEL CODE	19
3.20	REPORTING DELAY, SELECT ZONES	19
3.21	REPORTING DELAY TIME	20
3.22	LOW BATTERY & AC DELAY ZONES	20
3.23	ZONE REPORTING CODES	20
3.24	ZONE 1 THROUGH ZONE 8 REPORTING CODE	20
3.25	ZONE 9 CODE (LOW BATTERY)	20
3.26	ZONE 10 CODE (AC POWER FAILURE)	20
3.27	ZONE 11 CODE (AUTOMATIC SELF-TEST)	20
3.28	ZONE 12 CODE (CLOSING REPORT)	20
3.29	ZONE 13 CODE (OPENING REPORT)	20
3.30	ZONE 14 CODE (STATION)	20
3.31	ZONE 15 CODE (BYPASSING REPORT)	21
3.32	ZONE 16 (TROUBLE REPORT)	21
	<b>PANEL FUNCTIONS</b>	<b>21-23</b>
3.33	FOLLOWER, SELECT ZONES	21
3.34	AUDIBLE PANIC, SELECT ZONES (24 HR)	21
3.35	SILENT PANIC, SELECT ZONES (24 HR)	21
3.36	AUDIBLE FIRE, SELECT ZONES (24 HR)	21
3.37	AUDIBLE BURGLARY, SELECT ZONES	21
3.38	DELAYED BURGLARY, SELECT ZONES	21
3.39	EXIT DELAY TIME	21
3.40	ENTRANCE DELAY TIME	21
3.41	BELL SHUT OFF TIME (X 2 MIN)	22
3.42	FIRE BELL SHUT-OFF	22
3.43	REPORTING DELAY AC/LOW BATTERY	22
3.44	REPORTING ATTEMPTS	22
3.45	SECOND NUMBER DIALING (AUXILIARY)	22
3.46	BOTH NUMBER DIALING (AUXILIARY)	22
3.47	SELF-TEST REPORTING CYCLE	22
3.48	KEYPAD AUDIBLE ALARM SELECT (FIRE OR BURGLARY)	22
3.49	KEYPAD INITIATED REPORTING CODES	22
3.50	DURESS REPORTING CODE	23
3.51	STATUS REPORTING CODE	23
3.52	LOW BATTERY RESTORE CODE	23
3.53	AC POWER FAILURE RESTORE CODE	23
3.54	DAY/NIGHT TROUBLE ZONES DISPLAY ENABLE	23
3.55	DAY/NIGHT TROUBLE ZONES REPORT ENABLE	23
3.56	PROGRAMMING DK-IV-F KEYPAD	24
	LIMITED WARRANTY	25

# SECTION I: INSTALLATION INSTRUCTIONS

## 1.0 SYSTEM DESCRIPTION

The SCANTRONIC Model AV-8000F "AVENGER VIII" is an eight zone control panel/digital communicator alarm system that consists of one AV-8000F panel and one model DK-IV-F digital control station. The AV-8000F can be custom tailored for each installation by programming an Electrically Erasable Programmable Read Only Memory (EEPROM) which is included with the system. Programming can be accomplished using either the DK-IV-F or the SCANTRONIC Model P-4000 EEPROM Programmer. For complete information concerning programmable features and use of the DK-IV-F to enter data and commands into the EEPROM, see Sections II and III of the AV-8000F Programming Instructions.

**NOTE: The system will not work without a programmed EEPROM.**

The material in this publication is for information purposes only and is subject to change without notice. Scantronic (USA) Inc. assumes no responsibility for any error which may appear in this publication.

## 1.1 INSTALLATION

### CAUTION

1. Do not short terminals 4, 9 or 10 to 3, 6 or 8 or Auxiliary output fuse will blow.
2. Do not connect battery until installation is complete.
3. Do not apply power until after step 16.

1. Mount control panel in a convenient location.
2. Mount DK-IV-F Keypad. The keypad may be either surface mounted or flush mounted into a double gang box. The keypad may also be flush mounted directly onto the wall using appropriate hardware (not supplied).
3. A U.L. listed audible warning device (piezo or equivalent) may be connected between terminals 25 and 9. The device may be located in the cabinet or it may be remote. The sounding device should operate at 12 Vdc, and must not require more than 50 mA. The device will produce a steady sound during Entrance Delay Time. The device will pulsate when the system is in the Test mode.
4. For single bell operation, connect a 12.5 V Bell or Siren to terminals 5 and 6. Observe polarity. Output is steady for burglary, pulsed for fire.
5. For dual bell operation, connect a 12.5 V Fire Bell or Siren to terminals 5 and 6 and a 12.5 V Burglary Bell or Siren to terminals 6 and 7. Observe polarity and make sure EEPROM memory location 53 is programmed for dual bell operation.
6. Unswitched 12.5 V is available at terminals 3 and 9 for auxiliary devices.
7. If a smoke detector is used, its 12.5 V power should be supplied through terminal 4 (12.5 V) and terminal 3 (common). This 12.5 V source will be interrupted for approximately 5 seconds, resetting the smoke detector after the second time the access code is entered as in clearing the alarm memory after a fire alarm has occurred.



The smoke detector output may be manually reset by simultaneously pressing **1** + **3** keypad combination when a "2" is programmed in Memory Location 53.

**NOTE: In order to meet the operational requirements in the standard for Household Fire warning systems, UL 985, the following outputs shall be connected to a maximum combined load of 300 mA: Auxiliary Power, keypad, fire, and status output terminals 25, 28, 29, 30, and 31.**

**The unit is capable of delivering 600 mA from the outputs specified above. If loaded to 600 mA, the unit does not comply with the operational requirements of UL985. However, it does meet the safety requirements of this standard.**

8. If the COURTESY OUTPUT is to be used to turn on a light during Exit and Entrance delay times, install an X-10 BA-284 Burglar Alarm interface. Connect the positive (+) terminal of the interface unit to the COURTESY OUTPUT TERMINAL 27 and the negative (-) lead to terminal 26.

## 1.1 INSTALLATION (continued)

9. Connect the eight (8) input zones to terminals 13-24. Make sure to use the supplied END OF LINE resistors as shown in Fig. 1.  
**NOTE: U.L. fire installations require use of EOL2200 resistors (Not supplied). Closed circuit loops are wired in series with the resistor, open circuit loops are wired across the resistor.**
10. If an OPERATE LED is desired (ON when unit is in reporting cycle), connect the cathode to terminal 31 and the anode to terminal 9.
11. If remote "READY" and "ARM" LEDs are desired, connect the anodes to terminal 9 and the cathodes to terminals 28 and 29 respectively.
12. If keyswitch operation is desired, connect a U.L. listed Momentary normally open switch between terminals 9 and 30. For U.L. installations, use a U.L. listed device.
13. Connect the F.C.C. approved telephone connection cable (Model TC-3) to terminals 32, 34, 35 and 36 as shown in Figure 1. Insulate all unused leads. **THE CABLE MUST BE PHYSICALLY SEPARATED FROM POWER AND SIGNAL LINES.**
14. Connect DK-IV-F to AV-8000F. Red lead to terminal 10. Blue lead to terminal 12. Black lead to terminal 8. Yellow lead to terminal 11. Refer to DK-IV-F Installer's Manual and User's Manual for complete instructions regarding DK-IV-F installation and options. **WIRES CONNECTING DK-IV-F to AV-8000F MUST BE KEPT AWAY FROM A.C. AND TELCO WIRING TO MINIMIZE TRANSIENT PROBLEMS DUE TO LIGHTNING.**
15. Connect Terminal 33 and Cabinet to an EARTH GROUND.  
**NOTE:**
  - 1) **Suggested earth ground and protection levels are:**
    - A) **Preferred protection - Separate metal grounding rod.**
    - B) **Acceptable Protection - Metal cold water pipe.**
  - 2) **Use at least 16 gauge wire between terminal 33 and earth ground.**
  - 3) **Keep wire run as short as possible and away from other panel wiring.**
  - 4) **Do not use an existing lightning rod ground; it can provide a path for lightning strikes to panel.**
16. Check all connections, verifying polarity.
17. Connect the transformer to terminals 1 and 2. Polarity is not important.
18. Plug the transformer to an unswitched 120 Vac receptacle. The indicators on the DK-IV-F should light.
19. Connect the BLACK FLYING LEAD to the negative (-) terminal of a 12-volt, rechargeable gel-type battery. Connect the RED FLYING LEAD to the positive (+) terminal of the battery. If the battery is not fully charged, allow 36 hours for battery to reach full charge.
20. Program the EEPROM for the desired system configuration and features. Refer to the AV-8000F Programming Instructions (Sections II and III) for proper procedures. After programming is completed, restore the system back to the panel and keypad modes.
21. Plug the telephone connection cable into the RJ31-X jack.
22. The system may now be Disarmed and Armed from the DK-IV-F using the (Factory Programmed) Access Code 123.  
Leave system Disarmed.
23. TESTING THE LOCAL SYSTEM USING THE DK-IV-F: Arm the system in the TEST MODE. (Press: Access Code, , TEST, then ). The audible warning devices will pulsate continuously during TEST, except when testing an Entrance Delay zone. During Entrance Delay time, the audible warning device will change to a steady sound (for 4 seconds in the TEST MODE) and then return to a pulsating sound. All loops may now be tested independently. Violate each loop separately. The Arm and Zone LEDs will flash on alarm. No need to reset panel after each zone test. Bell or Siren will shut off in 4 seconds and another zone can be tested.  
**NOTE: Zones violated while in the TEST MODE will not report to the Central Reporting Station. After all zones are tested, Disarm the panel. All audible warning devices will shut off and the master Arm LED will turn off.**



1.4 FIGURE 1

WIRING DIAGRAM FOR MODEL AV6000F HOUSEHOLD BURGLARY AND FIRE WARNING SYSTEM

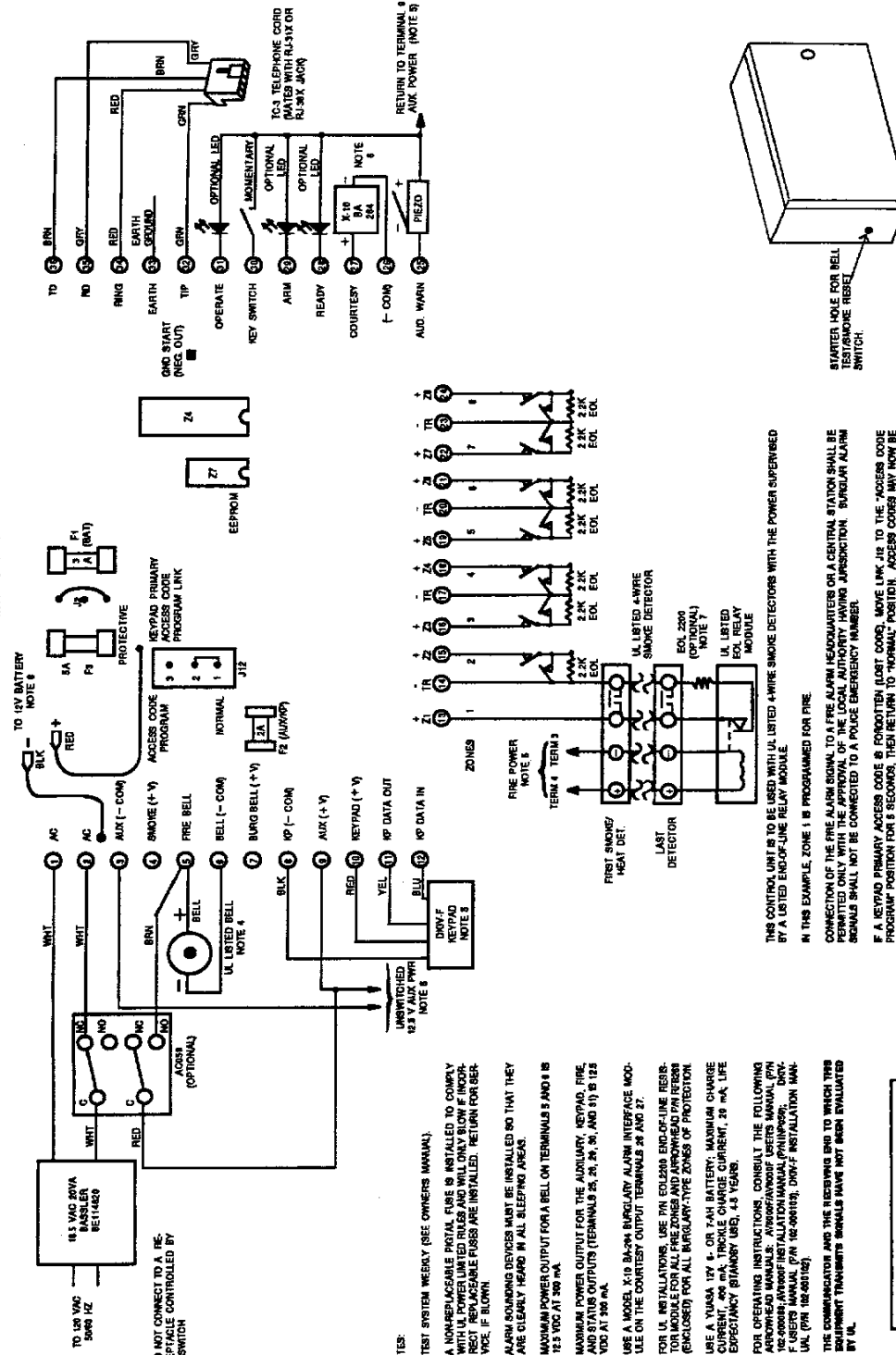

FIGURE 1A TEST SWITCH INSTALLATION

- NOTES:
1. TEST SYSTEM WEEKLY (SEE OWNERS MANUAL).
  2. A NON-REPLACIBLE PRITAL FUSE IS INSTALLED TO COMPLY WITH UL POWER LIMITED RULES AND WILL ONLY BLOW IF INCORRECTLY WIRING OR SHORTS ARE INSTALLED. RETURN FOR REPLACEMENT IF BLOWN.
  3. ALARM SOUNDING DEVICES MUST BE INSTALLED SO THAT THEY ARE CLEARLY HEARD IN ALL SLEEPING AREAS.
  4. MAXIMUM POWER OUTPUT FOR A BELL ON TERMINALS 5 AND 8 IS 12.5 VDC AT 300 mA.
  5. MAXIMUM POWER OUTPUT FOR THE AUXILIARY, KEYPAD, FIRE, SMOKE, AND BURGLAR ALARMS IS 12.5 VDC AT 125 mA. OUTPUTS (TERMINALS 25, 26, 28, 30, AND 31) IS 12.5 VDC AT 100 mA.
  6. USE A MODEL X-10 BURGLARY ALARM INTERFACE MODULE ON THE COURTESY OUTPUT TERMINALS 28 AND 27.
  7. FOR UL INSTALLATIONS, USE PNL END-OF-LINE RESISTOR MODULE FOR ALL FIRE ZONES AND APPROVED PNL RESISTOR MODULE FOR ALL BURGLARY-TYPE ZONES OF PROTECTION.
  8. USE A YUASA 17V 5. OR 7.4V BATTERY. MAXIMUM CHARGE CURRENT: 400 mA. THINLE CHARGE CURRENT: 20 mA. LIFE EXPECTANCY (STANDARD USE), 4.5 YEARS.
  9. FOR OPERATING INSTRUCTIONS, CONSULT THE FOLLOWING: (1) OPERATING INSTRUCTIONS (P/N 102-001104); (2) USER'S MANUAL (P/N 102-001103); (3) DOW-F INSTALLATION MANUAL (P/N 102-001102).
- THE COMMUNICATIONS AND THE RECEIVING END TO WHICH THIS EQUIPMENT TRANSMITS SIGNALS HAVE NOT BEEN EVALUATED BY UL.

COMPLIES WITH PART 68, FCC RULES FOR THE INTERFERENCE PROTECTION OF COMMUNICATIONS RECEIVERS EXEMPTED 9.13

THIS CONTROL UNIT IS TO BE USED WITH UL LISTED WIRE SMOKE DETECTORS WITH THE POWER SUPERVISED BY A LISTED END-OF-LINE RELAY MODULE.

IN THIS EXAMPLE, ZONE 1 IS PROGRAMMED FOR FIRE.

CONNECTION OF THE FIRE ALARM SIGNAL TO A FIRE ALARM SUBSTATION OR A CENTRAL STATION SHALL BE PERMITTED ONLY WITH THE APPROVAL OF THE LOCAL AUTHORITY HAVING JURISDICTION. BURGLARY ALARM SIGNALS SHALL NOT BE CONNECTED TO A POLICE EMERGENCY NUMBER.

IF A KEYPAD PRIMARY ACCESS CODE IS FORGOTTEN (LOST CODE), MOVE LINK #2 TO THE "ACCESS CODE PROGRAM" POSITION FOR 5 SECONDS, THEN RETURN TO "NORMAL" POSITION. ACCESS CODES MAY NOW BE PROGRAMMED AT EACH DETECTOR LOCATION.

**"WARNING"** OPERATOR SERVICE NOTICE. ELECTRICAL SHOCK HAZARD PRESENT DURING OPERATOR SERVICE OF TELEPHONE LINE TERMINALS 28 AND 31 AND PHONE TERMINALS 33 AND 34.

OUT AMPER 2. FOR UL AND CSFM INSTALLATIONS.

MOUNT ENCLOSURE SO THAT WIRE ATTACHES IN THE VERTICAL POSITION.

ALL DEVICES MUST USE UL RECOGNIZED LIMITED ENERGY CABLES.

FOR CSFM INSTALLATIONS, REFER TO THE INSTALLATION MANUAL (SEE NOTE 9).

## 1.5 SPECIFICATIONS

<b>Power Requirements:</b>	120 Vac, 20 VA, 16.5V transformer supplied. 12-volt battery, rechargeable gel-type, not supplied.
<b>Temperature Operating Range:</b>	35° F to 135° F. U.L.: 32° F to 120° F.
<b>Bell Output:</b>	<p>Burglary and Fire Output, 12.5 Vdc. In order to meet the operational requirements in the standard for Household Fire Warning Systems, UL985, the bell output shall be connected to a maximum combined load of 300mA.</p> <p>The unit is capable of delivering 2A from the bell output specified above. If loaded to 2A, the unit does not comply with the operational standard of UL985. However, it does meet the safety requirements of this standard.</p>
<b>Auxiliary Power Output:</b>	<p>12.5 VDC, regulated. In order to meet the operational requirements in the standard for Household Fire Warning Systems, UL985, the following outputs shall be connected to a maximum combined load of 300 mA: Auxiliary Power, Keypad, Fire, and Status Output terminals 25, 28, 29, 30, and 31.</p> <p>The unit is capable of delivering 600 mA from the outputs specified above. If loaded to 600 mA, the unit does not comply with the operational requirements of UL985. However, it does meet the safety requirements of this standard.</p>
<b>Transient and Lightning Protection:</b>	Lightning and surge protection provided on all input, power and telephone lines.
<b>Zone Response Time:</b>	220 mSec. During reporting cycle, response time increases to approximately 1 second.
<b>Maximum Loop Resistance:</b>	Do Not exceed 300 ohms on any zone loop (not including EOL Resistor).
<b>Dimensions:</b>	13" H x 10 3/4" W x 2 3/4" D.
<b>Shipping Weight:</b>	10 lbs.
<b>FCC Registration Number:</b>	AB798Z-67793-AL-E. AB7CSR-18556-AL-E.
<b>Ringer Equivalence:</b>	0.1B

## 1.6 OPTIONAL ACCESSORIES

### COURTESY OUTPUT

A +5 Vdc voltage is available at terminal 27 during Exit/Entrance times, and can be used to operate a line carrier lamp driver, etc.. A X-10 BA-285 Burglar Alarm interface, Ademco 477 Burglar Alarm Interface or equivalent product can be used.

### DK-IV-F

A digital arming station that allows full system status from one or more convenient locations. 8 LEDs display zone status and alarm memory for each zone; 8 LEDs display armed status of each burglary zone; 3 LEDs display general loop status, instant/delay mode and general armed status. Up to 5 DKIV-Fs may be used.

### P-4000

An EEPROM portable field programmer with complete digital readout of both data and memory location makes programming even easier. The P-4000 enables duplicate EEPROMS to be made from a master while permitting the addition of account numbers and other individual programming if desired.

### EOL2200

Underwriters Laboratories Inc. requires that the end-of-line register model EOL2200 be used for fire zones.

### BELL/BATTERY/AND FIRE TEST SWITCH

A D.P.D.T. push button switch (order SCANTRONIC part number AC058) may be installed to reset smoke detectors and/or provide convenient batter/bell test. Wire as shown in Figure 1. The switch should be mounted on the left side of the cabinet as shown in Figure 1A. If smoke detectors are not used, the violet wire need not be connected. Make sure all splices are soldered and not exposed.



## 1.7 FCC COMPLIANCE

This equipment generates and uses radio frequency energy and if not installed and used properly, that is, in strict accordance with the manufacturer's instructions, may cause interference to radio and television reception. It has been type tested and found to comply with the limits for a Class B computing device in accordance with the specifications of Subpart J of part 15 of FCC rules, which are designed to provide reasonable protection against such interference in a residential installation. However, there is no guarantee that interference will not occur in a particular installation. If this equipment does cause interference to radio or television reception, which can be determined by turning the equipment off and on, the user is encouraged to try to correct the interference by one or more of the following measures:

1. Reorient the TV or radio antenna.
2. Relocate or move the alarm control away from the receiver.
3. Plug the transformer for the alarm control into a different outlet so that the receiver and the alarm are on different branch circuits.
4. If necessary, the user should consult the alarm dealer or an experienced radio/television technician for additional suggestions. The user may find the following booklet prepared by the Federal Communications Commission helpful: "How to Identify and Resolve Radio-TV Interference Problems." This booklet is available from the U.S. Government Printing Office, Washington, DC 20402, stock #004-000-00345-4.

## 1.8 CANADIAN INSTALLATIONS

**NOTE: The Canadian Department of Communications label identifies certified equipment. This certification means that the equipment meets certain telecommunications network protective, operational and safety requirements. The Department does not guarantee the equipment will operate to the user's satisfaction.**

Before installing the equipment, users should ensure that it is permissible to be connected to the facilities of the local telecommunications company. The equipment must also be installed using an acceptable method of connection. In some cases, the company's inside wiring associated with a single line individual service may be extended by means of a certified connector assembly (telephone extension cord). The customer should be aware that compliance with the above conditions may not prevent degradation of service in some situations.

Repairs to certified equipment should be made by an authorized Canadian maintenance facility designated by the supplier. Any repairs or alterations made by the user to this equipment, or equipment malfunctions, may give the telecommunications company cause to request the user to disconnect the equipment.

Users should ensure for their own protection that the electrical ground connections of the power utility, telephone lines and internal metallic water pipe system, if present, are connected together. This precaution may be particularly important in rural areas.

**CAUTION: Users should not attempt to make such connections themselves, but should contact the appropriate electric inspection authority, or electrician as appropriate.**

The Load Number (LN) assigned to each terminal device denotes the percentage of the total load to be connected to a telephone loop which is used by the device to prevent overloading. The termination on the loop may consist of any combination of devices subject only to the requirements that the total of the Load Numbers of all the devices does not exceed 100. The load number for this equipment is LN-30.

This digital apparatus does not exceed the Class B limits for radio noise emissions from digital apparatus as set out in the radio interference regulations of the Canadian Department of Communications.

Le présent appareil numérique n'émet pas de bruits radioélectriques dépassant les limites applicables aux appareils numériques de Classe B prescrites dans le règlement sur le brouillage radioélectriques édicté par le Ministère des Communications du Canada.

## 1.9 U.L. COMPLIANCE/VERIFICATION

Follow the instructions below when installing and programming an AV-8000F/AV-8000W Alarm Control Panel to meet installation requirements.

### HARDWARE CONSIDERATIONS

1. Do not plug the Basler transformer into a receptacle controlled by a switch.
2. Use a 12 volt 6AH battery (Yuasa NP6-12) in order to have a standby time of at least 4 hours.
3. Use a U.L. listed bell across terminals 5 and 6. Terminals 6 and 7 are not to be used for a sounding output device since a constant and pulsing output is not available.
4. Maximum combined Auxiliary, keypad, fire, and status outputs (terminals 25, 28, 29, 30, and 31) is 300 mA at 12.5 VDC.
5. Use P/N EOL 2200 end-of-line resistor (optional) for all fire zones and SCANTRONIC P/N RFB268 (enclosed) for all burglary type zones of protection.
6. Maximum bell load is 300mA at 12.5 VDC. Use U.L. listed Bell or sounding device. Suggested Bells: Wheelock MB-G10-12-R or Amseco MSB-10G.
7. Use U.L. listed 4-wire smoke detector and U.L. listed end-of-line relay module.
8. Use AC058 Bell/battery/fire test switch which is mounted to the alarm enclosure.
9. Jumper J2 must be cut on the P.C. Assembly. See Figure 1. (U.L. and C.S.F.M. requirement).
10. The optional single or double gang plastic GEM box used for mounting the DK-IV-F keypad must be U.L. listed.
11. If the Audible warning output is used on terminal 25, a U.L. listed piezo must be used. Suggested piezo: Amseco P.A.L. 328.
12. If the Courtesy output is used, use a X-10 BA-285 Burglar alarm interface.
13. Use a U.L. listed momentary keyswitch if keyswitch operation is desired. Suggested keyswitch: Medeco model 65-2150-T-011-26-71.

### PROGRAMMING CONSIDERATIONS

1. Maximum Exit time allowed is 60 seconds. (Memory location 86)
2. Maximum Entry time allowed is 40 seconds. (Memory location 87)
3. Program all alarm sounding devices to operate for a minimum of 4 minutes. (Memory location 88)
4. Program manual shutdown on the fire alarm time out. (Memory location 89 must be a "1")
5. Program Fire power reset through the keypad (**1** & **3**) (Memory location 53 should be a "2")

## 1.10 CALIFORNIA STATE FIRE MARSHALL INSTALLATION CONSIDERATIONS

For C.S.F.M. installations, a Power Sonic 12 volt 8 AH battery (Model PS-1282L) must be used in order to achieve 24 hour battery back-up time. Maximum current draw from the Auxiliary and Bell output are as follows:

Auxiliary, Fire, Keypad, Output. Includes terminals 25 to 31 = 197 mA Max.

Bell output - 300 mA Max.

# SECTION II: PROGRAMMING INSTRUCTIONS

## Using The DK-IV-F as a Programmer

### GENERAL

#### 2.0 INTRODUCTION

Whether you are an experienced installer/programmer or a newcomer you will find programming and installing the AV-8000F simple and easy to understand. For those familiar with programming SCANTRONIC or other products, a reading of Section II with an occasional glance at Section III (DEFINITIONS) is probably all that is necessary. For those that are new to programming, a thorough reading of Sections II and III is recommended.

The EEPROM in the AV-8000F may be programmed either by a separate programmer or by the DK-IV-F, which comes with the system. These instructions describe how the DK-IV-F is used for this purpose. A free permanent overlay for the DK-IV-F is also available from your distributor or Scantronic (USA) Inc. to simplify the use of the Digi-Key, or use the temporary overlay printed on the DK-IV-F box.

#### 2.1 PROGRAMMING MODE

Both the panel and the DK-IV-F must be placed in the "PROGRAM" mode in order to program the AV-8000F. This is accomplished by the following key sequences:

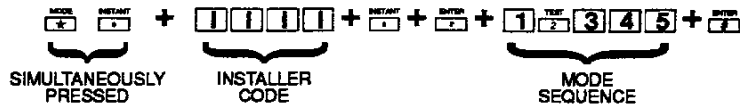

Successful entry into the Panel Program mode is indicated by the piezo sounder "beeping".

When programming is complete, return DK-IV-F to the "keypad" mode as follows:

Press **4** and **6** simultaneously. Then press **ENTER**.

**NOTE:** Failure to return the DK-IV-F to the keypad mode will result in improper operation. If this occurs, return the DK-IV-F to the program mode and repeat above in proper sequence.

### DISPLAY

#### 2.2 LED ARRANGEMENT

The two columns of 9 LED's may be thought of as a two-digit decimal display with the left column representing the tens' digit and the right column representing the units' digit. The top LED represents a "one", the bottom LED represents a "nine". When all LEDs are off, a "blank" is being displayed. When the yellow LED is on, either blinking or steady, the display is showing a memory location; when the yellow LED is off, the display is showing the data. A blinking yellow LED indicates a Memory Location that exceeds 99. For example, the Figure below (which has a steady yellow LED) indicates memory location 76 (● indicates the LED is on).

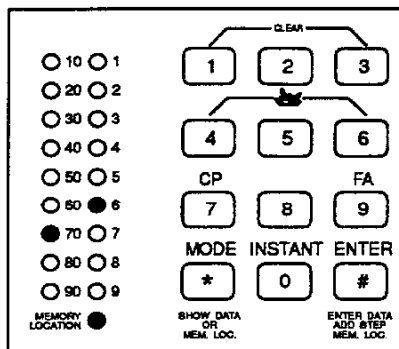

**NOTE:** A Programming overlay is included in this fax on the next page.

Cut out the overlay along the edge and then poke out the black holes. After that, follow the instructions on the previous page.

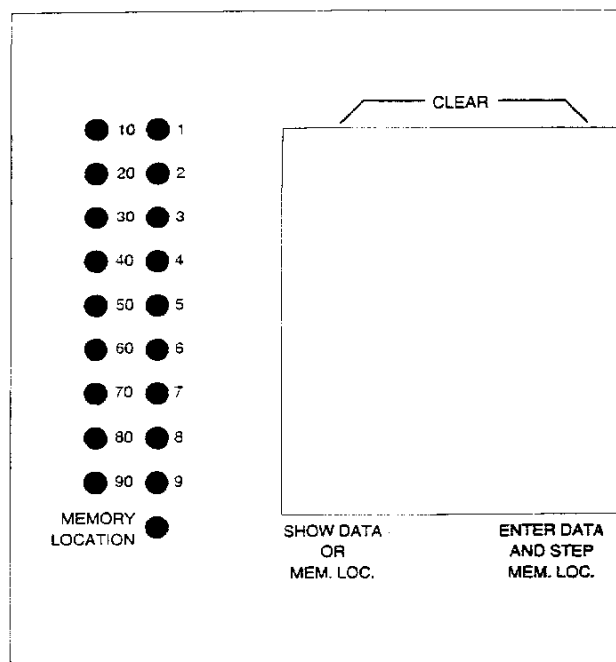

This may not have faxed at exact size. Enlarging or shrinking using a copy machine may be necessary for the overlay to fit.

## 2.2 LED ARRANGEMENT (continued)

The  is used to switch back and forth between these two display modes. When in the memory location mode, the display shows the current memory location and the keypad can be used to move to any desired location.

When in the data mode (the yellow LED off), the display shows the contents of the current memory location and the keypad can be used to modify data. The EEPROM is capable of storing two types of data, each of which is displayed and manipulated differently.

## 2.3 NUMERIC DATA

NUMERIC DATA is used to store telephone numbers, account codes, entrance/exit delays, etc.

## 2.4 SELECTION DATA

SELECTION DATA displays specific data selected for special functions (burglary zones or fire zones, for example) or (Touch Tone dialing and False Alarm shutdown, for example).

DISPLAY of Selection data uses only the top 8 LED's of the right hand column and specifies the functions selected. For example, the figure below indicates that zones 2, 4, 6 and 7 have been selected.

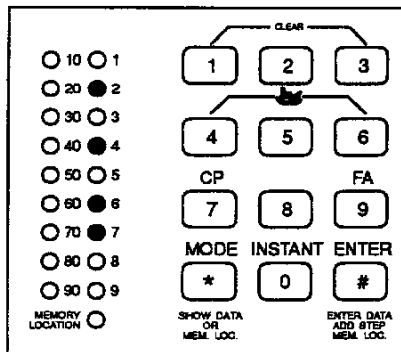

## KEYPAD

### 2.5 CHANGING MEMORY LOCATIONS AND VIEWING DATA

Changing Memory Locations and Viewing Data is accomplished in the following manner. If the display is not showing, a Memory Location (Yellow LED ON), press .







THE NUMERIC KEYS enter numbers into the display in the same way as a standard calculator; that is, each entry shifts the contents of the units' digit into the tens' digit and then places the new entry in the units' digit. For example:



To go to location 76, enter 076. To go to location 1, enter 001.

**NOTE: To avoid confusion, each entry should be 3 digits long.**



## 2.6 PROGRAMMING NUMERIC DATA

The following example shows how to program a telephone number. Let's program the primary phone number to dial 3647200.

A review of the programming work sheet (Figure 4) shows that the first digit of the first number starts in memory location "1". To program the telephone number, display memory location "1". Next press  to switch the display to show data. Next, press  , press  , press  , press  , press  , press  , and continue this sequence until the last digit "0" is entered. Notice that the digit "0" is displayed as a 10. This is similar to the "0" on a rotary telephone dial. Although the dial is marked with a "0", the actual number of pulses transmitted is 10.

After programming the last telephone digit, the  &  must be pressed simultaneously. This will "clear" the next memory location by entering a true "0", which must be done to inform the AV-8000F that the dialing sequence is complete.

## 2.7 REVIEWING THE DATA







In order to review the telephone number or any other data, the following procedure is used. Go to memory location "1" (start of the first telephone number). Switch the display to view data, a 3 will be displayed (first dialed digit); press  again, a 6 will be displayed; press  , a 4 will be displayed. Every time  is pressed, the memory location is advanced and the associated data is displayed. When the last digit is displayed, switch the display to show the Memory Location. Since the last dialed digit is the 7th digit, the display will show 7. This last step is not necessary, and is intended to show the relationship between the Memory Location and its associated data. It also shows a way to check for errors.

## 2.8 REPROGRAMMING NUMERIC DATA



It is not necessary to "clear" existing numeric data when reprogramming, just reprogram over the old data — **unless the data is a one (1)**. In this case the location must be first cleared (pressing  &  simultaneously), then enter the new data.

## 2.9 PROGRAMMING SELECTION DATA

The following example shows how to select Zones 2, 4 6 and 7 for Burglary. A review of the Programming Worksheet shows Burglary Functions are assigned to Memory Location 84.

Set the display to Memory Location 084. Change display to show data. If random data appears, press clear key combination ( & ). The display will indicate no zones selected (all LEDs in right hand column are out). Press  , press  , press  , press  . Notice as you press each key, its associated LED lights up in the right column indicating you have selected that zone. If the information is correct, press  . That location is now programmed. If incorrect, press the clear keys again and re-select zones. Unlike numeric data (where a new entry overwrites an old entry) selection data must be cleared if an error is made.

PROGRAMMING SELECTION DATA other than Zone data is the same as Programming Zone Data. Example: Select Touch Tone Dialing and False Alarm Shutdown. The Memory Assignment Chart shows location 53 contains the numbers to be entered. A "1" for Touch Tone dialing and a "3" for False Alarm Shutdown.



Set the display to show the data in Memory Location 53. If clearing is required, do so. If not, press  then  . Display will now show the "1" and "3" LEDs lit in the right hand column. Press  . This location is now programmed.

## SUMMARY

### 2.10 MODE KEY

Changes the display. Display can view a memory location or its associated data, but not both at the same time. Pressing the  allows alternating between viewing a memory location or its contents (data).

### 2.11 ENTER KEY

When the display shows a memory location, pressing the  will advance that memory location. When the display shows data, pressing the  enters the displayed data into the EEPROM and advances to the next memory location.

### 2.12 NUMERIC KEYS

**WHEN DISPLAY SHOWS MEMORY LOCATIONS.** Used to change memory locations. Examples: display shows 76 and 1 is desired, enter the following key sequence: 0 0 1. The display now shows 1.

**WHEN DISPLAY SHOWS DATA AND NUMERIC DATA ENTRY IS REQUIRED.** Use numbers 0 thru 15 to enter data. A "0" entry will program and display 10.

**WHEN DISPLAY SHOWS DATA AND SELECTION DATA ENTRY IS REQUIRED.** Use keys 1 thru 8 to enter Function data.  will select all function numbers (1 thru 8).

**WHEN THE DISPLAY SHOWS DATA AND THE CLEAR KEY FUNCTION IS REQUIRED.** Pressing the clear key combination  &  simultaneously programs a blank in the associated memory location. This function is used to "clear" data when necessary.

**NOTE: This function must be used after programming the last telephone number digit.**

## EXAMPLES AND FIGURES

### 2.13 PROGRAMMING EXAMPLE

This programming example shows two telephone numbers programmed to access second (outside) Dial Tone. Zones, Mode Selection and Reporting Codes are as follows:

#### ZONES AND MODES SELECTED

Touch Tone Dialing  
False Alarm Shutdown  
Extended Format All Zones Telephone #1  
(not used with SK 4 + 2)  
Std. Format Telephone #2  
Restore Zones 2, 3, 4  
Fire Zone 1  
Burglary Zones 2-7  
Silent Panic Zone 8  
Test Cancel Zones 4 & 5 (not allowed for SK 4 + 2)  
Delayed Burglary 2 & 3  
Dual Bell Operation  
8 Reporting Attempts  
Keypad Emergency (1 & 3)  
Keypad Emergency (4 & 6)  
Keypad Emergency (★ & #)

#### REPORTING CODES SELECTED

Acct Number 123 (both Primary and Secondary)  
Test Cancel Code = 9  
Restore Code = 14(E) - Change to "2" for SK 4 + 2  
Low Battery Code = 8 - Change to "6" for SK 4 + 2  
Opening Code = 11(B) - Change to "9" for SK 4 + 2  
Closing Code = 12(C) - Change to "4" for SK 4 + 2  
Self-Test Code = 13(D) - Change to "3" for SK 4 + 2  
Test Cycle = 1 (24 Hrs.)  
Zones 2-7 Reporting Code = 3 - Change to "0" for SK 4 + 2  
Zone 1 = Code 1  
Zone 8 = Code 2  
Station Code = 7  
Keypad Emergency (4 & 6) = Code 4 (Audible Panic)  
Keypad Emergency (★ & #) = Code 2 (Silent Panic)  
Keypad Emergency (1 & 3) = Code 1 (Audible Fire)

This example is shown on the sample programming worksheet. See Figure 2.

# AV-8000 PROGRAMMING WORKSHEET

CUSTOMER NAME \_\_\_\_\_

CUSTOMER ADDRESS \_\_\_\_\_

ACCOUNT # \_\_\_\_\_

MEMORY LOCATION	DESCRIPTION	DATA ENTERED																				FACTORY DEFAULT	
		1	2	3	4	5	6	7	8	9	10	11	12	13	14	15	16	17	18	19	20		21
( 1 - 21 )	FIRST TELEPHONE MEMORY LOCATIONS																						
	FIRST TELEPHONE NUMBER DIGITS	9	4	1	8	0	0	5	5	5	1	2	1	2									
( 22 - 41 )	SECOND TELEPHONE MEMORY LOCATIONS	22	23	24	25	26	27	28	29	30	31	32	33	34	35	36	37	38	39	40	41	42	
	SECOND TELEPHONE NUMBER DIGITS	9	4	5	5	5	1	2	1	2													
( 43 - 46 )	FIRST ACCOUNT NUMBER MEMORY LOCATIONS							43	44	45	46												
	FIRST ACCOUNT NUMBER DIGITS							1	2	3													
( 47 - 50 )	SECOND ACCOUNT NUMBER MEMORY LOCATIONS							47	48	49	50												
	SECOND ACCOUNT NUMBER DIGITS							1	2	3													
								ENTER NUMBERS	(SELECT ZONES)														
									1	2	3	4	5	6	7	8							
51	DIAL SECOND NUMBER ONLY, SELECT ZONES																						
52	DIAL BOTH NUMBERS, SELECT ZONES																						
53	1=T/T DIALING 2=MANUAL SMOKE RESET 3=FALSE ALARM SHUTDOWN 4=EUR. MAKE/BREAK 6=DKII/DKIII OPERATION 7=DUAL BELL OPERATION 8=FAILURE TO COMM. DISABLE																						ROTARY SINGLE BELL
									1		3									7			
54	TEL #1 2=EXT.REP. 4=SK4+2 8=ACRON							2															
55	TEL #2 2=EXT.REP. 4=SK4+2 8=ACRON																						
57	RESTORE ZONES									2	3	4											
58	ZONE RESTORE CODE (1-15)							14	(E)														
59	TEST CANCEL ZONES											4	5										
60	ZONE TEST CANCEL CODE (1-15)							9															
61	REPORTING DELAY ZONES																						
62	ZONE REPORTING DELAY (x 10 secs)																						
63	1=LOW BATT DELAY SELECT 2=A/C DELAY SELECT																						
64	ZONE 1 REPORT CODE (1-15)																						1
65	ZONE 2 REPORT CODE (1-15)																						2
66	ZONE 3 REPORT CODE (1-15)																						3
67	ZONE 4 REPORT CODE (1-15)																						4
68	ZONE 5 REPORT CODE (1-15)																						5
69	ZONE 6 REPORT CODE (1-15)																						6
70	ZONE 7 REPORT CODE (1-15)																						7
71	ZONE 8 REPORT CODE (1-15)																						8
72	LOW BATTERY REPORT CODE (1-15)																						
73	A/C LOSS REPORT CODE (1-15)																						
74	SELF TEST REPORT CODE (1-15)																						
75	CLOSING REPORT CODE (1-15)																						
76	OPENING REPORT CODE (1-15)																						
77	STATION REPORT CODE (1-15)																						
78	BYPASSING REPORT CODE (1-15)																						
79	TROUBLE REPORT CODE (1-15)																						





Figure 3 shows how this information would be reported on various formats.

### 2.15 RECEIVER FORMAT EXAMPLE

FIGURE 3

CONDITION	STANDARD	EXTENDED	4 + 2 SILENT KNIGHT	ACRON
A) Trip on Zone 1	123 1	123 1 111 1	1234 01	Account 123 Zone 1 2 3 4 5 6 7 8 Code F
B) Momentary Trip on Zone 2	123 3	123 3 333 2	1234 02	Account 123 Zone 1 2 3 4 5 6 7 8 Code T 3
C) Disarm after alarm report	123 E	123 E EEE 2	1234 22	Account 123 Zone 1 2 3 4 5 6 7 8 Code T E
D) Momentary trip on Zone 3	123 3	123 3 333 3	1234 03	Account 123 Zone 1 2 3 4 5 6 7 8 Code T 3
E) Momentary trip on Zone 5, disarm before alarm report and Zone 3 restores	123 9 123 E	123 9 999 5 123 E EEE 3	1234 05 1234 23	Account 123 Zone 1 2 3 4 5 6 7 8 Code T E 9
F) Momentary trip on Zone 4 disarm before alarm report	123 9	123 9 999 4	1234 04	Account 123 Zone 1 2 3 4 5 6 7 8 Code T 9
G) Momentary trip on Zone 4	123 3	123 3 333 4	1234 04	Account 123 Zone 1 2 3 4 5 6 7 8 Code T 3
H) Disarm after alarm report	123 E	123 E EEE 4	1234 24	Account 123 Zone 1 2 3 4 5 6 7 8 Code T E
I) Opening (By User)	123 B	123 B * BBB 3	1234 93	Account 123 Zone 1 2 3 4 5 6 7 8 Code T B
J) Closing (By User)	123 C	123 C * CCC 3	1234 43	Account 123 Zone 1 2 3 4 5 6 7 8 Code T C
K) Low Battery	123 8	123 8 888 0	1234 60	Account 123 Zone 1 2 3 4 5 6 7 8 Code 8 8 8 8 8 8 8 8
L) Station Code	123 7	** 123 7 777 2	1234 72	Account 123 Zone 1 2 3 4 5 6 7 8 Code 7
M) 24-Hour Self-Test	123 D	123 D DDD-O	1234 30	Account 123 Zone 1 2 3 4 5 6 7 8 Code D D D D D D D D

#### NOTES

- 1) The "T" in Acron Format (conditions B - H) indicates Zone 1 is still tripped. In addition to the alarm which caused the report, the status of all zones is reported during each alarm transmission; a "T" indicates a tripped zone, while a blank space indicates a zone which is not violated.
- 2) The Acron Format value for Zone 1 must be changed to any other value except 1. In this example we have selected code 15 (F).

\* Reports user codes 1 through 8 for Opening/Closing by user. This example shows user 3. For additional information see Avenger DK-IV-F Instructions.

\*\* This example shows Station Code = 7, Access Code = 234, and Station #2 Opening and Closing.

# AV-8000 PROGRAMMING WORKSHEET

CUSTOMER NAME \_\_\_\_\_

CUSTOMER ADDRESS \_\_\_\_\_

ACCOUNT # \_\_\_\_\_

MEMORY LOCATION	DESCRIPTION	DATA ENTERED																				FACTORY DEFAULT		
		1	2	3	4	5	6	7	8	9	10	11	12	13	14	15	16	17	18	19	20		21	
( 1 - 21 )	FIRST TELEPHONE MEMORY LOCATIONS																						ROTARY SINGLE BELL	
	FIRST TELEPHONE NUMBER DIGITS																							
( 22 - 41 )	SECOND TELEPHONE MEMORY LOCATIONS	22	23	24	25	26	27	28	29	30	31	32	33	34	35	36	37	38	39	40	41	42		
	SECOND TELEPHONE NUMBER DIGITS																							
( 43 - 46 )	FIRST ACCOUNT NUMBER MEMORY LOCATIONS							4 3	4 4	4 5	4 6													
	FIRST ACCOUNT NUMBER DIGITS																							
( 47 - 50 )	SECOND ACCOUNT NUMBER MEMORY LOCATIONS							4 7	4 8	4 9	5 0													
	SECOND ACCOUNT NUMBER DIGITS																							
								ENTER NUMBERS																
									(SELECT ZONES)															
51	DIAL SECOND NUMBER ONLY, SELECT ZONES							1	2	3	4	5	6	7	8									
52	DIAL BOTH NUMBERS, SELECT ZONES																							
53	1=T/T DIALING 2=MANUAL SMOKE RESET 3=FALSE ALARM SHUTDOWN 4=EUR. MAKE/BREAK 6=DKII/DKIII OPERATION 7=DUAL BELL OPERATION 8=FAILURE TO COMM. DISABLE																							
54	TEL #1 2=EXT.REP. 4=SK4+2 8=ACRON																							
55	TEL #2 2=EXT.REP. 4=SK4+2 8=ACRON																							
57	RESTORE ZONES																							
58	ZONE RESTORE CODE (1 - 15)																							
59	TEST CANCEL ZONES																							
60	ZONE TEST CANCEL CODE (1 - 15)																							
61	REPORTING DELAY ZONES																							
62	ZONE REPORTING DELAY (x 10 secs)																							
63	1=LOW BATT DELAY SELECT 2=A/C DELAY SELECT																							
64	ZONE 1 REPORT CODE (1 - 15)																					1		
65	ZONE 2 REPORT CODE (1 - 15)																					2		
66	ZONE 3 REPORT CODE (1 - 15)																					3		
67	ZONE 4 REPORT CODE (1 - 15)																					4		
68	ZONE 5 REPORT CODE (1 - 15)																					5		
69	ZONE 6 REPORT CODE (1 - 15)																					6		
70	ZONE 7 REPORT CODE (1 - 15)																					7		
71	ZONE 8 REPORT CODE (1 - 15)																					8		
72	LOW BATTERY REPORT CODE (1 - 15)																							
73	A/C LOSS REPORT CODE (1 - 15)																							
74	SELF TEST REPORT CODE (1 - 15)																							
75	CLOSING REPORT CODE (1 - 15)																							
76	OPENING REPORT CODE (1 - 15)																							
77	STATION REPORT CODE (1 - 15)																							
78	BYPASSING REPORT CODE (1 - 15)																							
79	TROUBLE REPORT CODE (1 - 15)																							

		(SELECT ZONES)								FACTORY								
		1	2	3	4	5	6	7	8	DEFAULT								
80	FOLLOWER ZONES																	
81	AUDIBLE PANIC, SELECT ZONES (24HR)																	
82	SILENT PANIC, SELECT ZONES (24HR)																	
83	AUDIBLE FIRE, SELECT ZONES (24HR)																	
84	AUDIBLE BURGLARY, SELECT ZONES									1								
85	DELAYED BURGLARY, SELECT ZONES									2345678								
86	EXIT DELAY TIME (x 10 secs) (0 - 15)									3								
87	ENTRANCE DELAY TIME (x 10 secs) (0 - 15)									3								
88	BELL OFF TIMER (x 2mins) (1 - 15)									8=16 MIN								
89	FIRE BELL (1=MANUAL, 0=AUTO)									AUTO								
90	AC/LOW BATTERY REPORT DELAY (x 1min)																	
91	NUMBER OF REPORT ATTEMPTS (CLR=UNLIMITED)									8								
95	DIAL 2ND NUMBER ONLY, AUXILIARY 1=LOW BATT 2=AC 3=SELF TEST 4=O/C/S 5=KYPD & DURESS 7=BYPASS 8=ZONE TROUBLE																	
96	DIAL BOTH NUMBERS, AUXILIARY																	
97	SELF TEST CYCLES (x24HR) (CLR=16)																	
98	BURGLARY AND FIRE									BURG OUTPUT (1 & 3)	1		FIRE OUTPUT (1 & 3)		5			
	BELL SELECT FOR									BURG OUTPUT (4 & 6)	2		FIRE OUTPUT (4 & 6)		6			
	EMERG. KEY PAIRS:									BURG OUTPUT (7 & 9)	3		FIRE OUTPUT (7 & 9)		7			
	FIRE HAS PRIORITY	BURG OUTPUT (* & #)	4		FIRE OUTPUT (* & #)		8											
99	KEYPAD (1 & 3) REPORT CODE (1 - 15)																	
100	KEYPAD (4 & 6) REPORT CODE (1 - 15)																	
101	KEYPAD (7 & 9) REPORT CODE (1 - 15)																	
102	KEYPAD (* & #) REPORT CODE (1 - 15)																	
103	DURESS REPORT CODE (1 - 15)																	
104	STATUS REPORT CODE (1 - 15)																	
105	LOW BATTERY RESTORE CODE (1 - 15)																	
106	AC POWER FAIL RESTORE CODE (1 - 15)																	
		(SELECT ZONES)																
		1	2	3	4	5	6	7	8									
144	DAY/NIGHT TROUBLE ZONES DISPLAY ENABLE																	
145	DAY/NIGHT ZONES REPORT ENABLE																	

INSTALLATION NOTES

---



---



---



---



---



---



---



---

# SECTION III: PROGRAMMING INSTRUCTIONS

<b>MEMORY LOCATION</b>	<b>DEFINITIONS</b>
<b>1-42</b>	<p><b>3.0 TELEPHONE NUMBERS</b> The AV-8000F is capable of reporting to two different telephone numbers. Telephone numbers are entered into the appropriate Memory Locations.</p> <p>Each number may be up to 20 digits long. The first number must be programmed in memory locations 1-21. The 2nd number in locations 22-42.</p> <p>If the communicator function is not to be used, Location 1 must be cleared.</p> <p>If more than 20 digits are required, the second telephone number's memory locations may be used to dial a single long number of up to 41 digits which must begin in memory location 1. In addition to the telephone number, two special function numbers may be inserted:</p> <ol style="list-style-type: none"><li><b>1) SECOND DIAL TONE</b> In installations where two dial tones are received (first for internal line and second for outside line). The AV-8000F may be programmed to detect a second dial tone by entering a "14" between the internal line number and the outside line number.</li><li><b>2) DIALING PAUSE</b> In areas where a dialing pause is required a dialing pause may be programmed after any dialing digit by entering a "15". The dialing pause is approximately 5 seconds.</li></ol>
<b>1-21</b>	<p><b>3.1 FIRST NUMBER DIALING</b> Spaces 1-20 are reserved for entering the first telephone number. Start at Memory Location 1.</p> <p>The location after the last digit must contain a true "0" (cleared); therefore location 21 is cleared when a 20 digit telephone number is used.</p>
<b>22-42</b>	<p><b>3.2 SECOND NUMBER DIALING</b> Spaces 22-41 are reserved for entering the second telephone number. Start at Memory Location 22. In special cases when a longer telephone number is required, these spaces may be used. There are three second number dialing modes.</p> <ol style="list-style-type: none"><li><b>1) BACK-UP REPORTING</b> If the primary receiver does not answer after two attempts, the second number will be called for the next two attempts. This alternation process between both numbers will repeat until the programmed number of attempts are completed.</li><li><b>2) DIAL-SECOND NUMBER ONLY (See Memory Locations 51 &amp; 55)</b> Zones may be selected to dial second number only. Useful for reporting non-emergency conditions without tying up the primary receiver. For example, using a zone for testing on demand.</li><li><b>3) DIAL BOTH NUMBERS (See Memory Locations 52, 54 &amp; 55)</b> Zones may be selected to dial both numbers. Used in high security applications where redundant reporting is desired.</li></ol>
<b>43-46</b>	<p><b>3.3 FIRST ACCOUNT NUMBER</b> A three or four digit account number can be used, beginning in Memory Location 43. If a 3 digit account number is required, location 46 must be cleared. Hexadecimal digits may be programmed when required. Although these are programmed as 10 through 15, some receivers will display them as letters A through F. Some receivers will not accept a four digit account number.</p>

**MEMORY LOCATION DEFINITIONS**

---

- 47-50 3.4 SECOND ACCOUNT NUMBER**  
A second account number may be entered beginning in Memory Location 47. If a 3 digit account number is required, location 50 must be cleared.  
*NOTE: A second account number must be programmed whenever a second telephone number is used.*
- 51 3.5 DIAL SECOND NUMBER ONLY, SELECT ZONES**  
Any combination of the 8 zones may be selected to Dial Second Number Only.
- 52 3.6 DIAL BOTH NUMBERS, SELECT ZONES**  
Any combination of the 8 zones may be selected to dial both numbers.
- 53 3.7 ROTARY/TOUCH TONE DIALING**  
Rotary dialing is factory programmed. If Touch Tone Dialing is desired, a "1" must be programmed in Memory Location 53. If touch tone dialing is to be changed to rotary dialing, the "1" in Memory Location 53 must be cleared.
- 3.8 MANUAL SMOKE RESET**  
The smoke detector output may be manually reset by simultaneously pressing the 1-3 keypad combination, to select this feature program a "2" in this location.  
*NOTE: U.L. installations require a "2" to be programmed in this location.*
- 3.9 FALSE ALARM SHUT DOWN (SWINGER REJECTION)**  
This feature is not factory programmed. This feature may be selected by programming a "3" in Memory Location 53. When this feature is selected, 4 reports on the same zone within a 2-hour period will shut down that zone and ignore alarm signals for 24 hours or until system is armed or disarmed again.
- 3.10 EUROPEAN MAKE/BREAK**  
American standard make/break rotary dialing ratio of 60/40 is factory programmed. If European make/break ratio of 70/30 is desired enter a "4" in Memory Location 53.
- 3.11 DK-III or DK-II OPERATION**  
This allows the AV-8000F to be used with the older Digi-Key models in replacement of existing systems. To select this feature, program a "6" in this memory location.  
*NOTE: Not to be used with DK-IV-F keypads.*
- 3.12 DUAL BELL OPERATION**  
Single bell operation is factory programmed. For single bell operation alarm output at AV-8000F terminals 5 and 6 is steady for a tripped burglary zone or audible panic and pulsating for a tripped fire zone or fire panic. Fire has priority.  
  
If dual bell operation is desired program a "7" in Memory Location 53. For dual bell operation a steady output is provided at AV-8000F terminals 5 and 6 for annunciation of a tripped fire zone or fire panic condition, and a steady output is provided at AV-8000F terminals 6 and 7 for tripped burglary zone or audible panic.
- 3.13 INHIBIT FAILURE TO COMMUNICATE**  
If Failure to Communicate function is not desired, program an "8" in Memory Location 53.

54

**3.14 RECEIVER FORMATS FOR THE FIRST TELEPHONE NUMBER**

If this memory location is cleared, the standard reporting format will be selected.

Entering a "2" will select EXTENDED REPORTING. (This method allows compatibility with Radionics receivers for open/close by user and other special features.)

Entering a "4" will select SILENT KNIGHT 4 + 2 format.

When using SILENT KNIGHT 4 + 2 reporting format, the AV-8000F should be programmed as follows:

1. 4 Account digits must be used.
2. Memory Locations 64 to 71 must contain "10" or "A".
3. If Restores are desired, Memory Location 58 should contain "2".
4. Test Cancel should not be used.

When using the non-emergency codes (Low Battery, Opening, Closing and Self-Test) with SILENT KNIGHT 4 + 2 format, these codes should be programmed as follows:

Memory Location 72 Low Battery	= 6
Memory Location 76 Opening	= 9
Memory Location 75 Closing	= 4
Memory Location 74 Self-Test	= 3

Entering an 8 will select Acron superfast format.

**NOTE: If two number reporting is used, 2 different receiver formats may be used. Example: Acron Superfast format receiver on one number and Ademco 660 "Slow" format receiver on the other.**

55

**3.15 RECEIVER FORMATS FOR THE SECOND TELEPHONE NUMBER**

Specific zones may be selected to dial both telephone numbers or second telephone number only. Memory Locations 51 and 52 are used to select zones 1 through 8 for emergency reporting. Memory Locations 95 and 96 are used to select non-emergency reporting conditions.

Receiver formats for telephone #2 are selected in the same manner as telephone #1. See Memory Location 54.

57

**3.16 RESTORE, SELECT ZONES**

Select zones which will report restores. A restore is defined as a return to normal after a zone has previously been tripped. If a burglary zone is tripped, a restore report will be sent when the panel is Disarmed after reporting to the receiver. 24-Hour zones report Restorals when the zone restores after reporting to the receiver.

58

**3.17 RESTORE CODE**

Enter restore code desired in this location.

59

**3.18 TEST CANCEL, SELECT ZONES**

Select zones which will report test cancels. If a test cancel zone is tripped and restored before transmission of the alarm code is completed, the Test Cancel Code will be sent. On burglary zones the Test Cancel Code will be sent if the system is Disarmed prior to transmission. 24-Hour zones report Test Cancel only if the zone restores before the transmission is completed.

60

**3.19 TEST CANCEL CODE**

Enter Test Cancel Code desired in this location.

61

**3.20 REPORTING DELAY, SELECT ZONES**

Select zones which will delay before dialing out to the receiver. If an alarm signal on a 24-Hour delay zone restores prior to expiration of the delay time, the zone will not report out, but audible and silent zones latch in (sounding alarm and flashing the LEDs) until the panel is armed or disarmed).

If the panel is disarmed prior to the expiration of the delay time, all audible zones (including burglary zones) will not report out.

**MEMORY LOCATION DEFINITIONS**

---

- 62 3.21 REPORTING DELAY TIME**  
Enter the reporting delay time desired in this location.
- Delays from 10 to 150 seconds may be selected in 10-second increments. Enter a "1" for 10 seconds, a "2" for 20 seconds, up to a "15" for 150 seconds.
- 63 3.22 LOW BATTERY & AC DELAY ZONES**  
Entering a "1" in this Memory Location will delay the Low Battery Report. If the low battery signal restores prior to the expiration of delay time, the low battery signal will not report out.
- Entering a "2" in this Memory Location will delay the AC power failure report. If AC power restores prior to expiration of delay time, the AC power failure signal will not report out.
- Either a Low Battery or AC zone may be selected. If both are selected, the reporting delay time applies to both. If either or both are selected, a reporting delay time must be programmed in Memory Location 90.
- 3.23 ZONE REPORTING CODES**  
Memory Locations 64 through 79 are reserved for entering zone reporting codes. Zones 1 through 8 are factory programmed, all others are cleared. The factory programmed code for Zone 1 is 1, Zone 2 is 2, and so on through Zone 8.
- Memory Locations 72 through 79 are non-emergency reporting zones.
- 64 Through 71 3.24 ZONE 1 THROUGH ZONE 8 REPORTING CODE**
- 72 3.25 ZONE 9 CODE (LOW BATTERY)**  
An automatic low battery report is generated when battery voltage fails to a low level and a reporting code is selected in this Memory Location.
- 73 3.26 ZONE 10 CODE (AC POWER FAILURE)**  
An AC Power failure condition report is generated when a reporting code is selected in this Memory Location.
- 74 3.27 ZONE 11 CODE (AUTOMATIC SELF-TEST)**  
Enter reporting code to represent an automatic test report that will automatically report once every day to once every sixteen days. Self-test period is selected in Memory Location 97.
- 75 3.28 ZONE 12 CODE (CLOSING REPORT)**  
Enter reporting code to represent a closing (arming) report. Closing report is sent after exit delay time expires. If exit delay time is not programmed, closing report will be sent immediately.
- 76 3.29 ZONE 13 CODE (OPENING REPORT)**  
Enter reporting code to represent an opening (disarming) report. Opening report is sent when system is disarmed.
- NOTE: Opening and closing reports are used to notify the Central Monitoring Station when the system is disarmed (opening) and armed (closing).**
- An example of opening and closing reporting is shown on page 14.
- Opening and closing "By User" can identify up to eight users per keypad in the Extended, SILENT KNIGHT 4 + 2 and SCANTRONIC reporting formats. (See AV-8000F DK-IV-F Instructions.)
- If failure to communicate occurs prior to completion of an opening or closing by user report, and a different user subsequently opens or closes, then the original user code is replaced by the last user code when communications is re-established.
- 77 3.30 ZONE 14 CODE (STATION)**  
Enter reporting code to enable station code reporting in this Memory Location. This report should be used in conjunction with Opening/Closing report by user in Extended, SCANTRONIC Superfast or SILENT KNIGHT 4 + 2 formats. Station number is determined by first digit of the primary access code. The Station I.D. Code will also



**MEMORY LOCATION DEFINITIONS**

---

**88 3.41 BELL SHUT OFF TIME (X 2 MIN)**  
From 2 to 30 minutes may be entered in 2-minute increments. Enter a "1" for 2 minutes, a "2" for 4 minutes, etc., up to a "15" for 30 minutes. U.L. installations require 4 or more minutes of alarm.

**89 3.42 FIRE BELL SHUT-OFF**  
The Fire Bell will time out as determined by Memory Location 88 (Auto Shut-Off). If set to "1", the fire bell will not shut off unless manually reset. This is a requirement in some states (i.e., California). If the manual shut-off mode is to be changed to the auto shut-off mode, the "1" must be cleared.

**90 3.43 REPORTING DELAY AC/LOW BATTERY**  
Enter the reporting delay time desired for AC Power Failure and Low Battery reports in this location.  
  
Delays from 1 minute to 15 minutes may be selected in 1-minute increments. Enter a "1" for 1 minute, a "2" for 2 minutes, up to a "15" for 15 minutes. If both Low Battery and AC Power Failure zone are selected, the delay time is the same.

**91 3.44 REPORTING ATTEMPTS**  
Enter the number of reporting attempts desired in this location. If this location is cleared, the AV-8000F will continue to dial until a shut down signal is received from the receiver (in countries where allowed). If any number 1 - 15 is entered, the unit will shut down after the entered number of attempts and retain this information until a new report occurs. Example: 8 is programmed and the Central Station is temporarily down. After 8 attempts, the AV-8000F will not attempt to communicate until a new report occurs.

**95 3.45 SECOND NUMBER DIALING (AUXILIARY)**  
To select Second Number Dialing for Auxiliary Reports, enter the following in the Memory Location:

1 = Low Battery	5 = Keypad Initiated Reports
2 = AC	7 = Bypass Reports
3 = Self-Test	8 = Zone Trouble Reports
4 = Opening/Closing/Station	

Example: If we require a Low Battery, AC Power Failure and Self-Test Report to Dial Second Number Only, a 1, 2 and 3 should be programmed in the Memory Location.

**96 3.46 BOTH NUMBER DIALING (AUXILIARY)**  
To select Auxiliary Reports to Dial Both Numbers, data should be entered in this Memory Location in the same manner as selecting Second Number Dialing.

**97 3.47 SELF-TEST REPORTING CYCLE**  
The Self-Test code programmed in Memory Location 74 can be reported from once every 24 hours to once every 16 days by entering a 1 through 15. Enter a "1" for a report every 24 hours, a "2" for every 2 days up to a "15" for every 15 days. For a report every 16 days, clear this Memory Location.

**98 3.48 KEYPAD AUDIBLE ALARM SELECT (FIRE OR BURGLARY)**  
Any or all of the four keypad pair combinations may be programmed to sound an audible alarm when a key pair is activated. Each key pair may sound either an audible burglary or fire alarm but not both. When not programmed, function is "silent" if reporting code is selected in Memory Locations 99-102.

Row 1 key pair (1 & 3) will sound burglary when a "1" is entered and fire when a "5" is entered.  
Row 2 key pair (4 & 6) will sound burglary when a "2" is entered and fire when a "6" is entered.  
Row 3 key pair (7 & 9) will sound burglary when a "3" is entered and fire when a "7" is entered.  
Row 4 key pair (\* & #) will sound burglary when a "4" is entered and fire when a "8" is entered.  
Examples: Row 1 is to sound fire and rows 2 and 3 are to sound burglary. Enter a "5", "2", and "3" in Location 98.

**3.49 KEYPAD INITIATED REPORTING CODES**  
Memory Locations 99 through 103 are used to select the reporting code keypad initiated 24-hour emergency alarms will report.

be sent whenever an emergency key pair is initiated.

## MEMORY LOCATION

## DEFINITIONS

---

- 78**                    **3.31 ZONE 15 CODE (BYPASSING REPORT)**  
Enter reporting code to enable bypass reporting in this Memory Location. This report when used in conjunction with Extended, SCANTRONIC Superfast or SILENT KNIGHT 4 + 2 formats will indicate (upon arming) which zone(s) have been bypassed.
- 79**                    **3.32 ZONE 16 (TROUBLE REPORT)**  
Enter reporting code to enable trouble reporting in this Memory Location. This report when used in conjunction with Extended, SCANTRONIC Superfast or SILENT KNIGHT 4 + 2 reporting formats will report trouble by zone as selected in Memory Location 145.

## PANEL FUNCTIONS

- 80**                    **3.33 FOLLOWER, SELECT ZONES**  
Selecting follower zones deactivates these zones during entrance and exit delay times. This feature allows the system user to walk in front of an intrusion detector when entering or exiting the premises via an entrance/exit delay zone. If a follower zone is violated when an exit delay is not in progress (when system is armed) or when an entrance delay is not in progress (entrance to premises was not through a delay zone), then the follower zone will instantly go into alarm. *These zones must also be selected for audible burglary.*
- 81\*\*\***                **3.34 AUDIBLE PANIC, SELECT ZONES (24 HR)**  
Select zones to be programmed for audible panic. The Armed LED will flash on alarm whether the panel is armed or disarmed.\* Zones selected for Audible Panic are always on. Any combination of zones 1 - 8 may be selected.
- 82\*\*\***                **3.35 SILENT PANIC, SELECT ZONES (24 HR)**  
Select zones to be programmed for silent panic. Whether the panel is armed or disarmed the Armed LED will not flash on alarm. And the zone LED will not light. Zones selected for Silent Panic are always on. Any combination of zones 1 - 8 may be selected.
- 83\*\*\***                **3.36 AUDIBLE FIRE, SELECT ZONES (24 HR)**  
Select zones to be programmed for audible fire. The Armed LED will flash on alarm whether the panel is armed or disarmed. Zones selected for Audible Fire are always on. Any combination of zones 1 - 8 may be selected.
- 84\*\*\***                **3.37 AUDIBLE BURGLARY, SELECT ZONES**  
Select zones to be programmed for audible burglary. Zones that are selected for Audible Burglary are on when armed and not bypassed. These zones can be armed and disarmed from the keypad. Any combination of zones 1 - 8 may be selected.
- 85**                    **3.38 DELAYED BURGLARY, SELECT ZONES**  
Select zones to be programmed for delayed burglary. These zones must be selected if an Entrance Delay or Exit Delay is desired. Any combination of Zones 1 - 8 may be selected. *These zones must also be selected for audible burglary.*
- 86**                    **3.39 EXIT DELAY TIME**  
Delays from 10 to 150 seconds may be selected in 10-second increments. When using a closing report an exit delay time should be entered even though an exit delay zone is not selected. This will prevent nuisance reports caused by user immediately disarming the system after arming.  
  
Enter a "1" for 10 seconds, a "2" for 20 seconds, up to a "15" for 150 seconds. For U.L. installations, maximum exit time allowed is 60 seconds.
- 87**                    **3.40 ENTRANCE DELAY TIME**  
Delays from 10 to 150 seconds may be selected in 10-second increments. Enter a "1" for 10 seconds, a "2" for 20 seconds, up to a "15" for 150 seconds. For U.L. installations, maximum entrance time allowed is 40 seconds.

---

\*\*\*Any zone not PROGRAMMED IN ANY OF THESE 4 LOCATIONS (81 through 84) becomes a 24-Hour Silent Zone by default. The armed LED will flash when tripped, whether the panel is armed or disarmed.

<b>MEMORY LOCATION</b>	<b>DEFINITIONS</b>
------------------------	--------------------

99	<b>KEYPAD 1 AND 3 REPORTING CODE</b>
100	<b>KEYPAD 4 AND 6 REPORTING CODE</b>
101	<b>KEYPAD 7 AND 9 REPORTING CODE</b>
102	<b>KEYPAD ★ &amp; # REPORTING CODE</b>
103	<p><b>3.50 DURESS REPORTING CODE</b>            Enter Reporting Code to enable Duress Report when a "0" is entered following the last digit of the Access Code. Then press .</p>
104	<p><b>3.51 STATUS REPORTING CODE</b>            To enable Status Reporting in the SCANTRONIC Superfast format a "1" must be entered. For Extended and SILENT KNIGHT 4 + 2 reporting formats enter reporting code to represent status report in this Memory Location. A status report indicates a zone currently violated and previously reported.</p>
105	<p><b>3.52 LOW BATTERY RESTORE CODE</b>            Entering a number in this Memory Location selects the code that will report when a low battery condition is restored.</p> <p><b>NOTE: This Memory Location must not be programmed if Memory Location 72 is not programmed.</b></p>
106	<p><b>3.53 AC POWER FAILURE RESTORE CODE</b>            Entering a number in this Memory Location selects the code that will report when an AC power failure condition restores.</p> <p><b>NOTE: This Memory Location must not be programmed if Memory Location 73 is not programmed.</b></p>
144	<p><b>3.54 DAY/NIGHT TROUBLE ZONES DISPLAY ENABLE</b>            Any combination of the 8 zones may be selected to display a trouble condition. Fire zones are automatically enabled. Burglary zones will sound and indicate a trouble condition when violated while disarmed. Useful for monitoring window foil breakage.</p>
145	<p><b>3.55 DAY/NIGHT TROUBLE ZONES REPORT ENABLE</b>            Any combination of the 8 zones may be selected to report a trouble condition. Burglary zones will report a trouble condition while violated when disarmed. Fire zones will report trouble whenever the trouble condition occurs. The reporting code selected in Memory Location 79 will be reported.</p>

# 3.56 PROGRAMMING DK-IV-F KEYPAD

## MEMORY LOCATION

## DEFINITIONS

- 0 3.0 CHIME ZONE SELECTION**  
Used in single premise operation, any audible burglary zone can be programmed to activate the piezo sounder briefly to announce that a door (typically) has opened or closed during the disarm period.
- 1 3.1 GROUP BYPASS ZONE SELECT**  
If desired, bypassable zone assigned in memory location 2 can be grouped together to allow bypassing by pressing:

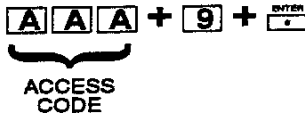

- 2 3.2 BYPASSABLE ZONE SELECT**  
Select zones to be programmed to allow bypassing. Zone(s) selected can be bypassed on arming. Zone(s) will remain bypassed until the system is rearmed. DO NOT ALLOW FIRE ZONES TO BE BY-PASSED.

- 3 3.3 DISPLAY ZONE SELECT**  
The DK-IV-F is shipped from the factory with all individual armed LED's enabled. Program the specific LED's that you wish to enable.

- 4 3.4 KEYPAD FUNCTION SELECT**  
**DISABLE AUDIBLE FEEDBACK** — The miniature sounding device with the DK-IV-F will "beep" whenever a key is pressed. This assures the user that the microcomputer inside the keypad has sensed the key stroke. For security reasons, the special emergency key pairs are silent. Selecting this feature will not effect normal operation of the sounder during pre-alert or at any other time it would normally turn on. To select this feature, program a "1" in this location.  
**DISABLE SOUNDER** — To completely disable the piezo sounder, program a "2" in this location.

**MULTIPREMISE** — Multipremise operation allows two or more users to share the same control panel. Each user will only be able to utilize and control the selected zones on their respective keypads. To select for multipremise operation, program a "4" in this location.

**CHIME ENABLE** — Programming a "5" in this location will activate the zones for chime operation programmed in location 0.

**PRODUCT COMPATIBILITY** — The DK-IV-F has been designed to work with all existing SCANTRONIC Avenger Series Control Panels. The DK-IV-F is programmed from the factory for operation with current models.

For operation with earlier version AV-6000/8000 Control Panels indicated by Micro Version 3113, program a "7" in this location.

For operation with all other model SCANTRONIC Control Panels, AV-2000, AV-3000, AV-3100E, AV-4000, etc., program a 7 and an 8 in this location.

- 5-8 3.5 INSTALLER ACCESS CODE SELECT**  
Programming the system can only be accomplished by using the installer code in the program sequence. The installer code may not be used to arm and disarm the system. Enter your desired four (4) digit code into this location. The factory default value for the installer code is 1111.

**NOTE:** The installer code must be four (digits) in length.

- 9-16 ABBREVIATED ARMING LENGTH SELECT**  
Abbreviated arming allows the customer to arm the system by using only one (1) to three (3) digits of the access code. Program the desired number of abbreviated arming digits for users one (1) through eight (8) in this location.

- 17-22 USER 1 ACCESS CODE**  
Program the desired three (3) to six (6) digit access code for User 1 in this location. Factory default value for User 1 is (123).

### 23-64 USER 2 - 8 ACCESS CODES

Program the desired three (3) to six (6) digit access code for User 2 - 8 in these locations.

### 65 STATION ID DIGIT

Program the desired station report code in this location. The station report will be generated when open and closing by user is selected. The station ID will also be sent whenever an emergency keypad is pressed.

## DK-IV-F PROGRAMMING WORKSHEET

LOC.	DESCRIPTION	SELECT ZONES							
		1	2	3	4	5	6	7	8
0	CHIME ZONE SELECTION **								
1	GROUP BYPASS ZONE SELECT								
2	BYPASSABLE ZONE SELECT (1-8)								
3	DISPLAYABLE ZONE SELECT (1-8)								
4	KEYPAD FUNCTION SELECT 1 = DISABLE AUDIBLE FEEDBACK 2 = DISABLE BUZZER 3 = NOT USED 4 = MULTI-PREMISE 5 = CHIME ENABLE **  7 = ALL PANELS EXCEPT AV-6000/8000 * 8 = ALL PANELS EXCEPT AV-6000/8000								
5-8	INSTALLER ACCESS CODE 4 DIGITS ONLY (1111)								
9-16	ABBREVIATED ARMING LENGTH	9	USER 1	13	USER 5	10	USER 2	14	USER 7
		11	USER 3	15	USER 7	12	USER 4	16	USER 8
		17	18	19	20	21	22		
17-22	USER 1 ACCESS CODE (123)								
		23	24	25	26	27	28		
23-28	USER 2 ACCESS CODE								
		29	30	31	32	33	34		
29-35	USER 3 ACCESS CODE								
		35	36	37	38	39	40		
35-40	USER 4 ACCESS CODE								
		41	42	43	44	45	46		
41-46	USER 5 ACCESS CODE								
		47	48	49	50	51	52		
47-52	USER 6 ACCESS CODE								
		53	54	55	56	57	58		
53-58	USER 7 ACCESS CODE								
		59	60	61	62	63	64		
59-64	USER 8 ACCESS CODE								
65	STATION ID DIGIT (1)								

\* Early AV-6000/8000 panels require a 7 to be programmed. These can be identified by the number 3113 on the micro.

\*\* Both entries must be programmed for proper chime feature operation.