

---

# **VISTA XM SERIES**

---

---

## **4140XM/5130XM/4130XM INSTALLATION INSTRUCTIONS**

**A complete VISTA Technical Reference  
Manual that can unlock the full power of  
the VISTA XM System is available.  
See inside front cover for more  
information.**

**ADEMCO**

**CONGRATULATIONS**  
**and WELCOME to the VISTA XM FAMILY!**

The purpose of these Installation Instructions is to give you, the installer, a brief overview of the VISTA XM system, and provide instructions for installing a basic system. For more complete information, including descriptions of the VISTA XM series of products, detailed wiring diagrams and complete programming instructions, please refer to the VISTA XM TECHNICAL REFERENCE MANUAL, available from our Technical Support Group (call one of the numbers listed below), or you can pick one up at your local Ademco Distribution Center.

As always, ADEMCO is there for YOU! Our SALES and TECHNICAL SUPPORT staff are eager to assist you in any way they can, so don't hesitate to call, for any reason!

*East Coast Technical Support: 1-800-645-7492 (8 a.m.-6 p.m. E.S.T.)*

*West Coast Technical Support: 1-800-458-9469 (8 a.m.-5 p.m. P.S.T.)*

Again, CONGRATULATIONS, and WELCOME ABOARD!

**Dear Valued Customer:**

**To help provide you with the best possible products and service, please take a few minutes to complete this survey and drop it in the mail. We value your comments and look forward to hearing from you soon. Thank You.**

Your Company Name: \_\_\_\_\_

Address: \_\_\_\_\_

Your Name/Title: \_\_\_\_\_

Customer Number: \_\_\_\_\_ Phone Number: \_\_\_\_\_

1. Which VISTA XM system was installed?                      4140XM                      5130XM                      4130XM

2. a) Was wireless used?                      Yes                      No

b) How many 4280s (or 4280-8s) used?                      1                      2

3. Was two-wire expansion used?                      Yes                      No

If yes, which devices were used (check all that apply)?

- |   |   |
|---|---|
| <input type="checkbox"/> 4190WH 2 Zone Module                 | <input type="checkbox"/> 4192SD Photoelectric Smoke Detector                  |
| <input type="checkbox"/> 4208 8 Zone Module                   | <input type="checkbox"/> 4192SDT Photoelectric Smoke Detector w/Heat Detector |
| <input type="checkbox"/> 4139 Mini Surface Mount Reed Contact | <input type="checkbox"/> 4192CP Ionization Smoke Detector                     |
| <input type="checkbox"/> 4191 Mini Recessed Reed Contact      | <input type="checkbox"/> 4275 Dual Element PIR                                |
| <input type="checkbox"/> 4194 Wide Gap Reed Contact           | <input type="checkbox"/> 4196 Quad Element PIR                                |

4. a) How would you rate the new, 158 page *TECHNICAL REFERENCE MANUAL* overall? (available at Ademco Distribution Centers)

Poor                      Fair                      Good                      Excellent                      Did not use the TRM

b) If you chose poor or fair, what are some reasons? Please be specific. \_\_\_\_\_

\_\_\_\_\_

5. a) Did you download the program?                      Yes                      No

b) If yes, was it easy to do and understand?                      Yes                      No

c) If no, why not? Please be specific. \_\_\_\_\_

\_\_\_\_\_

d) Did you use the remote command feature?                      Yes                      No

e) If yes, are there any other features/commands you would like to see? Please be specific. \_\_\_\_\_

\_\_\_\_\_

6. a) Did you program via the keypad?                      Yes                      No

b) If yes, was it easy to do and understand?                      Yes                      No

c) If no, why not? Please be specific. \_\_\_\_\_

\_\_\_\_\_

7. What would you like to see in the future?

Outputs? \_\_\_\_\_

Keypad capabilities? \_\_\_\_\_

Control functions? \_\_\_\_\_

Other? \_\_\_\_\_

8. Additional comments or suggestions: \_\_\_\_\_

\_\_\_\_\_



Ademco  
Attn: VISTA Product Manager  
180 Michael Drive  
Syosset, NY 11791-9826

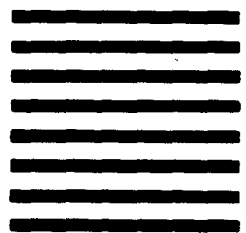

POSTAGE WILL BE PAID BY ADDRESSEE

**BUSINESS REPLY CARD**  
FIRST CLASS PERMIT NO. 185 • SYOSSET, NY 11791

NO POSTAGE  
NECESSARY  
IF MAILED  
IN THE  
UNITED STATES



**PLEASE FOLD THIS MAILER ALONG SCORED LINES SO THAT THE BUSINESS REPLY PORTION FACES OUT, SEAL IT WITH TAPE OR STAPLE, AND DROP IT IN THE MAIL. THANK YOU FOR YOUR HELP!**

# TABLE OF CONTENTS

I. GENERAL INFORMATION.....	4
II. ZONE TYPE DEFINITIONS.....	5
III. SYSTEM CONFIGURATION	
A. (ZONES).....	6
B. (PERIPHERALS).....	8
IV. MOUNTING AND POWERING THE SYSTEM.....	10
V. SYSTEM OPERATION.....	13
VI. SYSTEM COMMUNICATIONS.....	14
VII. PROGRAMMING THE SYSTEM.....	15
VIII. TESTING THE SYSTEM.....	16
IX. SPECIFICATIONS.....	17
— DIP SWITCH TABLES.....	18
— 4140XM SUMMARY OF CONNECTIONS DIAGRAM.....	19
— 4130XM/5130XM SUMMARY OF CONNECTIONS DIAGRAM.....	20
— PROGRAMMING FORM.....	21

**NOTE: References to the 4140XM refer to both the 4140XM and 4140ATX Controls.**

# I. GENERAL INFORMATION

## THE VISTA CONTROLS

The VISTA XM Controls are microprocessor based programmable systems and feature EEROM memory technology (power loss does not result in the loss of information). The Controls support up to 9 wired zones of protection, expandable to 64 zones (wired and/or wireless) when connected to a 2-wire polling loop.

## EASY PROGRAMMING

Programming can be performed at the office prior to installation, or on the job site directly from the keypad, or can be downloaded from a remote location by using the Ademco 4130PC Downloading Software.

For installer convenience, the Control is pre-programmed with a set of standard values that is designed to meet the needs of many installations. These values, however, can be changed to suit the needs of any particular installation. The Control can also be pre-programmed by the installer with one of four standard communication default programming values, eliminating the need for extensive programming time and effort.

## MEMORY-OF-ALARM

The VISTA Controls provide a memory-of-alarm feature, which, upon disarming the system, automatically displays all zones that were in an alarm condition while the system was armed. In addition, a 10 day alarm/trouble history is maintained by the system, which helps the installer or central station to identify problem sensors. To activate this feature, enter the security code + the [0] key.

## BUILT-IN USER'S MANUAL and DESCRIPTION REVIEW

For end-user convenience, the 5130XM and 4140XM (with 5137) contain a built-in Users Manual. By depressing and holding any of the function keys on the console for 5 seconds, a brief explanation of that particular function scrolls across the alpha-numeric display.

In addition, all programmed zone descriptors can be displayed (one at a time) by pressing and holding the READY key for 5 seconds, then releasing the key. This serves as a check for installers to be sure all descriptors are entered properly.

Three technologies to suit every installation:  
HARDWARE, SUPERVISED WIRELESS, 2-WIRE MULTIPLEX

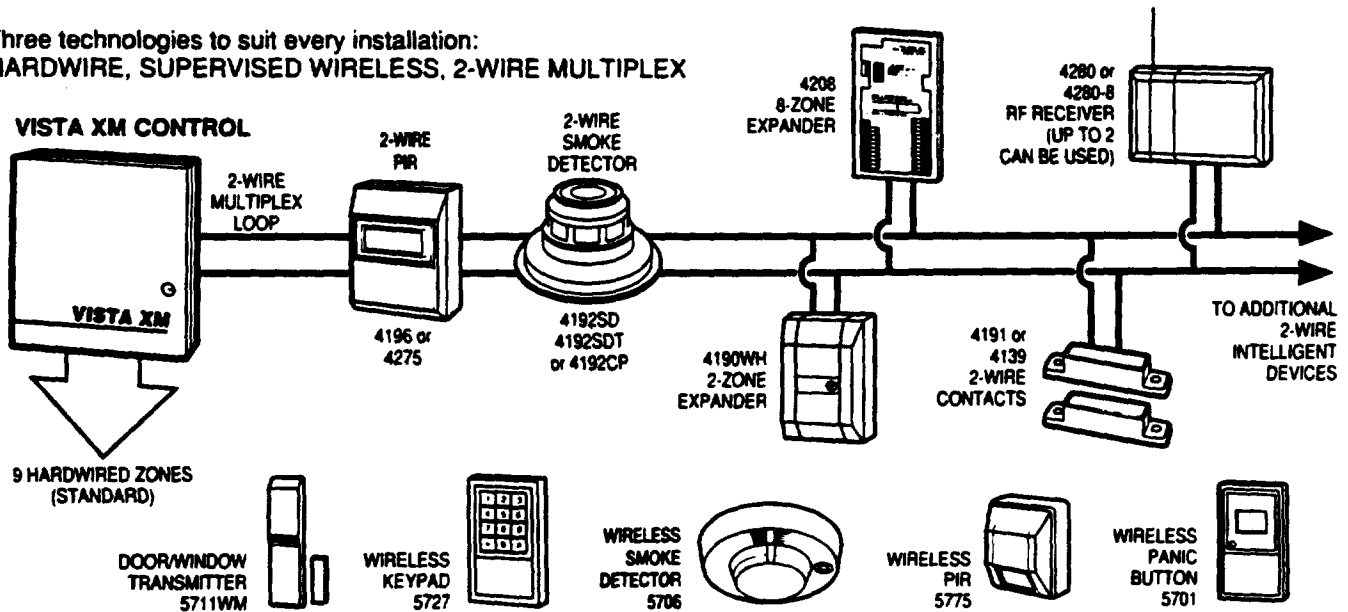

## II. ZONE TYPE DEFINITIONS

Each zone must be assigned to a zone type, which defines the way in which the system responds to faults in that zone. In addition, there are three keypad activated zones (PANIC keys), a polling loop supervision zone, and two RF receiver supervisory zones.

### **TYPE 1: ENTRY/EXIT #1**

Used for the primary entry/exit route (ex: front door, main entrance).

### **TYPE 2: ENTRY/EXIT #2**

Used for a secondary entry/exit route (ex: Garage door, loading dock door, basement door), where more time might be needed to get to and from the keypad.

### **TYPE 3: PERIMETER BURGLARY**

Used for exterior doors and/or windows which require an instant alarm when violated.

### **TYPE 4: INTERIOR BURGLARY (FOLLOWER)**

Used for areas where an entry delay is required only if an entry/exit delay zone is faulted first.

### **TYPE 5: DAY/NIGHT BURGLARY**

Used for zones which contain a foil-protected door or window (such as in a store), or to a zone covering a sensitive area such as a stock room, drug supply room, etc., or other controlled access area where immediate notification of an entry is desired.

### **TYPE 6: 24 HOUR SILENT ALARM**

This zone type is generally assigned to a zone containing a Hold-up or Panic button that is designed to initiate an alarm report to the Central Station, but which produces no visual displays or alarm sounds (ex: banks, jewelry counters).

### **TYPE 7: 24 HOUR AUDIBLE**

This type is also assigned to a zone containing a Panic button, but which will initiate an audible alarm in addition to an alarm report to the Central Station (ex: bedside panic).

### **TYPE 8: 24 HOUR AUXILIARY**

This type assigned to a zone containing a button for use in personal emergencies or to a zone containing monitoring devices such as water sensors, temperature sensors, etc. Designed to initiate an alarm report to the Central Station and only provides Console alarm sounds and alarm displays.

### **TYPE 9: SUPERVISED FIRE**

Used for zones containing smoke detectors, heat detectors, pull stations, etc. An open in this zone will initiate a trouble signal. A short in this zone will initiate a fire alarm (pulsed external sounder and report to central station).

### **TYPE 10: INTERIOR BURGLARY (DELAYED)**

This type is similar to type 4, except that entry delay begins whenever sensors in this zone are violated, regardless of whether or not an entry/exit delay zone was faulted first.

### III. (A) SYSTEM CONFIGURATION (ZONES) — BASIC 9 HARD-WIRED ZONES —

#### ZONE 1

This zone has a 350 millisecond response and can be assigned to any zone type and can be set up for EOLR supervision or for closed-circuit unsupervised use. This zone is the only zone that can support 2-wire smoke detectors (up to 3 BRK detectors) using an EOLR configuration.

If EOLR supervision is required, connect all closed-circuit sensors in series with one another to TB1-2, (4130XM/5130XM use RED/YELLOW & WHITE/BROWN wires) with the 13,000 ohm resistor in series with the loop, at the last device and then return the loop to TB2-4.

If no supervision is required, simply maintain a closed loop with all sensors connected in series with the loop, between TB1-1 and TB1-2 (or WHITE/BROWN & ORANGE). If the sensors used are open-circuit devices, such as smoke detectors, each one must be in parallel to the next using the EOLR configuration. The EOLR must then be placed across the last wired detector.

#### ZONES 2 THROUGH 8

These zones have a 350 millisecond response and can be assigned to any zone type. They can be EOLR supervised or closed circuit unsupervised, as required (program field \*41 determines whether or not these zones will use the 1,000 ohm EOLR: Enter [1] in field \*41 to disable the use of EOLRs on zones 2 through 8). If programmed for use with EOLRs, both closed-circuit and open-circuit devices can be used with the 1,000 ohm EOLR resistor in series with the loop at the last device. If the use of EOLRs is disabled (\*41=1), only closed-circuit devices can be used. Note that the maximum resistance per zone is 300 ohms.

#### ZONE 9

This zone is an unsupervised, fast response zone (5-10 milliseconds), and can be assigned to any zone type except fire. Only closed-circuit devices can be used in this zone. This zone should be used for fast response devices such as fast acting glass break sensors or vibration sensors. Avoid using mechanical magnetic or relay type contacts in this zone. Note that the maximum resistance for this zone is 100 ohms.

### — ZONE EXPANSION MODULE— (Required for zones 10 through 64)

#### 4171XT-XM/4152LMB

To expand the system using a 2-wire Polling Loop and/or wireless devices, a 4171XT-XM dialer board, and a 4152LMB Loop Module must be installed as shown below. (The 4171XT-XM is factory installed in the 4140XM.)

Wires from the 4208 Zone Expander, RPMs, and 4280 are connected to Terminals 1 & 2 on the 4152LMB.

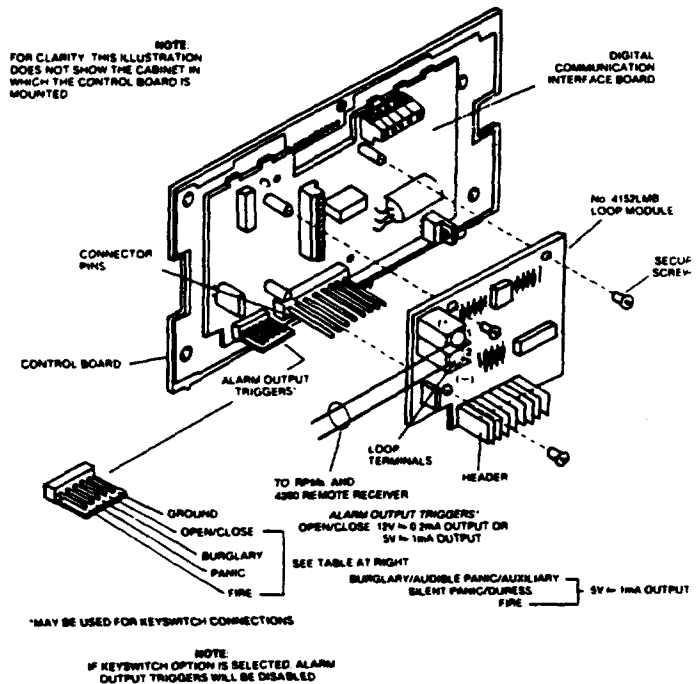



## — 2-WIRE POLLING LOOP EXPANSION — (Zones 10 through 64)

### GENERAL INFORMATION

To expand the system using a 2-wire polling loop and remote point modules (RPMs), a 4171XT-XM dialer board, and a 4152LMB loop module must be installed, as described in the ZONE EXPANSION MODULE section.

Wire each of the RPMs in parallel to the 2-wire polling loop, making sure no more than the maximum allowable wire length is used per individual polling loop run, as follows:

- #22 gauge @ 650' max
- #20 gauge @ 950' max
- #18 gauge @ 1500' max
- #16 gauge @ 2400' max

**NOTE:** Twisted pair recommended for all normal wire runs.

**IMPORTANT:** The maximum combined polling loop run is 4000'. If using shielded wire, the maximum is 2000'. If longer wire runs are needed, a 4197 Loop Extender Module must be used.

### CAUTION

If an intercom system is being used, the polling loop wires must be as far from the intercom wiring as possible (minimum 6"). If this spacing cannot be achieved, shielded wire must be used. If this is not done, interference on the intercom system might occur. Also note that the maximum total wire length supported is cut in half when shielded wire is used.

### ADVISORY

The maximum allowable current draw on the polling loop is 64mA. Refer to the Polling Loop Current Draw Worksheet (found in the POWERING THE SYSTEM section of this manual) for current draws of various polling loop devices. If more than 64mA is being drawn, use of the 4197 provides another loop with 64mA available. Refer to the instructions provided with the 4197, or the Technical Reference Manual for complete information.

## — WIRELESS EXPANSION—

The VISTA XM system supports up to 63 Alert III Transmitters, plus a wireless keypad. To expand the system using wireless, one or two 4280 RF Receivers (or 4280-8 if only 8 wireless zones are used) must be connected to the polling loop. The 4280 can receive signals from wireless transmitters within a nominal range of 200 feet. In addition, two 4280s can be used to provide either a greater area of coverage, or to provide redundant protection. Note that if using 2 RF Receivers, one of them must be powered from Auxiliary power.

**IMPORTANT:** All RF zones must be designated as such in their respective program fields. If using a 4280-8, only up to 8 zones can be enabled as RF zones. If more than 8 zones are enabled, the message "SET-UP ERROR" (5130XM/5137) or "E8" (4130XM/4137) will be displayed. For more information regarding the 4280 installation, refer to the Installation Instructions provided with the 4280.

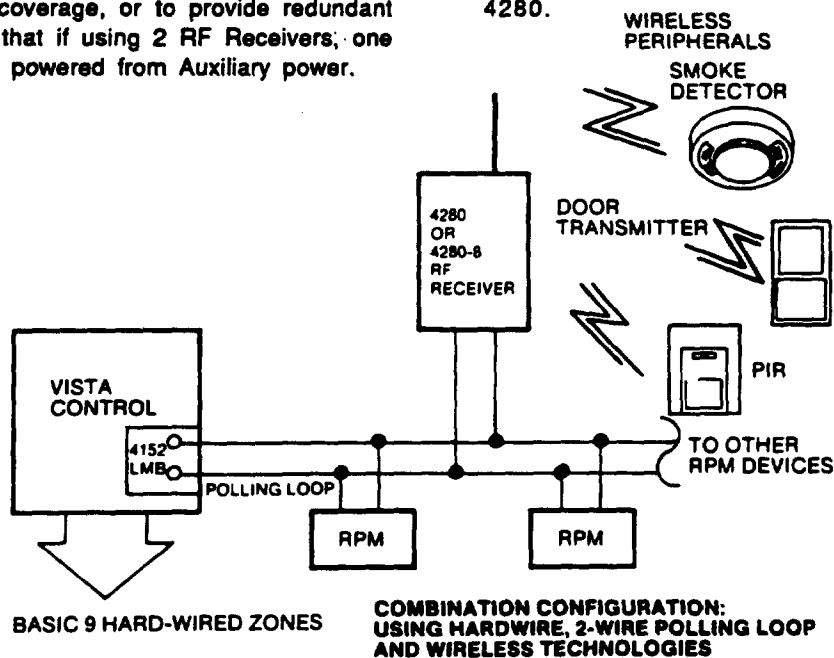

### III. (B) SYSTEM CONFIGURATION (PERIPHERALS) — REMOTE CONSOLES —

#### GENERAL

Both the 4130XM and the 5130XM supply up to 280mA (200mA for UL certificated installations) of auxiliary power for remote consoles and/or other auxiliary devices such as motion detectors or 4-wire smoke detectors. The 4140XM supplies up to 700mA for non-UL usage and up to 400mA for UL applications. You must keep this in mind when adding remote consoles so you don't over-draw current from the panel. This would result in a battery which is never fully charged, or possibly a blown auxiliary power fuse. Up to 7 remote consoles can be used.

In the event you need more than the allowed number of remote consoles, you can use a second 1350 power pack to power up to 7 extra 4137s/5137s. Instead of using the panel's auxiliary power connection to the red and black console lead, connect the Positive (+) terminal of the 1350 to the blue console lead, and the Negative (-) to the black lead. As long as AC power is present, these extra consoles are active. If AC is lost, the system's back-up battery will take over and only the consoles powered from auxiliary power will be active.

**NOTE:** If using a 4140XM, make sure you power at least one remote console from auxiliary power, otherwise there would be no means of controlling the panel during an AC loss.

#### 4137

- For use with the 4130XM, 4140XM or 5130XM Controls
- 60 mA current draw
- Power up to 7 consoles from the 4140XM.(non-UL)

#### 5137

- For use with the 4140XM or 5130XM Controls
- 60 mA current draw standby
- 90 mA current draw with backlighting
- Power up to 7 consoles from the 4140XM (non-UL)

### — SMOKE DETECTOR CONFIGURATIONS —

#### ZONE 1

When programmed as an EOLR supervised FIRE zone (type 09 in program field \*02), up to three 2-wire smoke detectors can be used. Recommended are the BRK1400 Ionization detector, 2400 Photoelectric smoke detector, and the 2400TH Photoelectric smoke detector with 135°F heat sensor.

#### ADVISORY

If the EOLR is not at the end of the loop, the zone is not fully supervised. The system will not respond to an open circuit within the zone.

#### ZONES 2 THROUGH 8

These zones can support as many 4-wire smoke detectors as can be powered, when programmed as a FIRE zone, type 09, in program field \*02. There are only two requirements: (1) The zones must be configured for EOLR supervision, and (2) A normally-closed, momentary switch must be installed in series with the power to the detectors in order to allow reset of the smoke detectors after an alarm. The detectors must be wired in parallel, with the EOLR at the last detector for full supervision.

#### POLLING LOOP SMOKE DETECTORS (4192SD, 4192SDT or 4192CP)

Can be added to the 2-wire Polling Loop via the 4152LMB loop module, on zones 10 through 64 (as programmed in fields \*03, \*04, \*05, 1\*01, 1\*02, 1\*03, 1\*04 and 1\*05). These detectors have a built-in RPM which is DIP switch programmable. They are wired in parallel to the polling loop, and do not need auxiliary power or a separate reset switch. The polling loop provides power and reset signals to the detectors, as well as alarm and trouble signals from the detectors. Refer to the polling loop wire run length table in the Polling Loop Expansion Section.

#### WIRELESS SMOKE DETECTOR

##### (5706)

Up to 8 smoke detectors can be used and assigned to zones 48-55 as long as these zones are enabled for RF usage and are programmed as Fire zones (type 09). A 4280 RF Receiver must be connected to the polling loop to support the wireless smoke detectors. Refer to the instructions provided with the 4280 for installation information.

## — PASSIVE INFRARED MOTION DETECTORS —

### GENERAL INFORMATION

Select a mounting site with the following notes in mind: Best coverage will be obtained if the mounting site is selected such that the likely direction of intruder motion is across the pattern of protection.

- Avoid locating the unit where central heating radiators, flames or heating outlet ducts are within the protective zones.
- Avoid locating the unit in direct sunlight or directly above strong sources of heat.
- Avoid locating the unit on unstable surfaces.
- Avoid running alarm wiring close to heavy duty electrical cables.

### POLLING LOOP PIR (4196)

The 4196 is a quad element passive infrared detector with a built-in RPM that is connected directly to the 2-wire polling loop.

### POLLING LOOP PIR (4275)

The 4275 is a dual element passive infrared detector, with a built-in RPM, that is connected directly to the 2-wire polling loop.

### WIRELESS PIR (5775)

The 5775 is a battery operated, wireless, dual element passive infrared motion detector that can be monitored by a 4280 (4280-8) wireless receiver. The 4280 is connected to the 2-wire polling loop.

## — PHONE LINE INTERFACE —

### 4171XT-XM/4171XM INSTALLATION

The 4171XT-XM is factory installed in the 4140XM Control. For the 4130XM/5130XM Controls, connect the 4171XT-XM or 4171XM as shown:

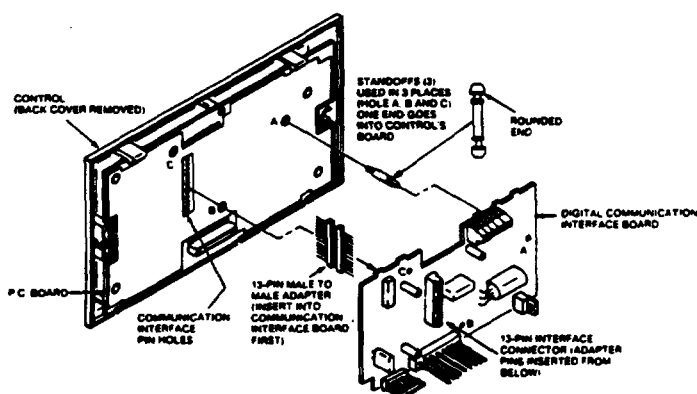

### 4171XT-XM/4171XM TERMINALS

Term. 1: Programmable output (see 1\*46) that can be used as a ground start output with the 675 Ground Start Module (not UL Listed), as an output to produce console audible warnings on a remote sounder (ex: No. 706-12), or as an open/close trigger for use with other communications media.

- Only one of the above options can be chosen.
- If either GROUND START, or CONSOLE AUDIBLE is used, Aux. Voltage Trigger pin 4 may not be used.

Term. 2: INCOMING PHONE LINE (TIP)

Term. 3: INCOMING PHONE LINE (RING)

Term. 4: LOCAL HANDSETS (RING)

Term. 5: LOCAL HANDSETS (TIP)

GROUND: Connect green flying lead to a proper earth ground.

**WARNING:** To prevent the risk of shock, disconnect phone lines at telco jack before servicing the unit.

## — EXTERNAL SOUNDERS —

### 4140XM

The 4140XM is housed in a metal cabinet and contains a built-in relay, rated at 2.8 amps. The output of this relay is a positive (+) trigger from terminal 8 on TB2, with the negative from TB2-15. Up to two 702s can be used wired in series; up to two 719s in parallel.

### 4130XM/5130XM

The 4130XM/5130XM self-contained Controls have an external sounder output of 100mA, (negative-going (-) trigger) from the brown lead. The continuous positive (+) is taken from the red/black lead. From this output you could use up to two 740 High Intensity Sounders, wired in parallel, or one Amseco Motor Bell, ABB1031, or up to eight indoor Piezo Sounders, BRK PA400B in parallel.

### 4148 RELAY MODULE (2.8 AMPS @28 VDC)

Other sounders (ex. 702 and 719 self-contained sirens) can be used with the 4130XM/5130XM, but the addition of the 4148 Relay Module is necessary because these sirens (or equivalent) draw more than the allowable 100mA of current.

### ADVISORY:

Going beyond the above mentioned limits will overload the auxiliary power and/or relay fuse. Note that the 5130XM and 4130XM use built-in solid state fuses (PTCs) that do not need replacing. The 4140XM uses standard fuses (located on the terminal strip) which must be replaced if blown.

97

## IV. MOUNTING AND POWERING THE SYSTEM

Note that field wiring to these controls/conssoles must be completed before the controls/conssoles can be mounted.

### SURFACE MOUNTING

1. Use the template provided (on a separate sheet) to mark the positions on the wall for the screw mounting holes and the cut-out for the wiring.
2. Pull the interface wiring in the wall through the cut-out.
3. Remove the console's back cover. The securing screw at the front of the console must be removed to release the back cover .
4. Pass the interface wiring through the opening in the back cover and through the 4143 Expansion Ring (if used), then mount the back cover to the wall surface with screws.
5. Splice the interface wiring to the console wires (or to the wires on the interface connector supplied with 4137s). Insulated solderless wire splices (eg. 311) may be used for splicing.
6. Attach the main body of the console to the wall-mounted back cover. The console is properly attached when it snaps into place. Use the securing screw (previously removed) to secure the console to the back cover .

### FLUSH MOUNTING WITH TRIM RING

1. Cut out a 4-3/4" high by 8" wide opening in the wall between studs, no less than 1-1/2" from either stud. Use the template provided to mark the cut-out.
2. Insert the four 1-1/2" long #6 screws through the mounting holes in the supplied Trim Ring and then attach the four metal securing clips, as shown in the diagram. Use only two or three turns of each screw, allowing the metal clips to hang freely. The clips must not protrude beyond the sides of the Trim Ring or you will not be able to install the Trim Ring into the cut-out in the next step.
3. Install the trim ring into the opening in the wall with the hinge clasps to the right. Making sure the trim ring is straight, tighten each clip screw, making sure that the attached clip slides down into its guide track.
4. Install the Console as follows: Engage the hinge clasps on the trim ring with the notches located in the back (right-hand side) of the Console's front panel. Swing the left side of the panel toward the trim ring (the panel will pivot on the hinge clasps), and press firmly until the panel "snaps" closed.
5. Use the panel securing screw (supplied with the Console) to secure the left side of the panel.

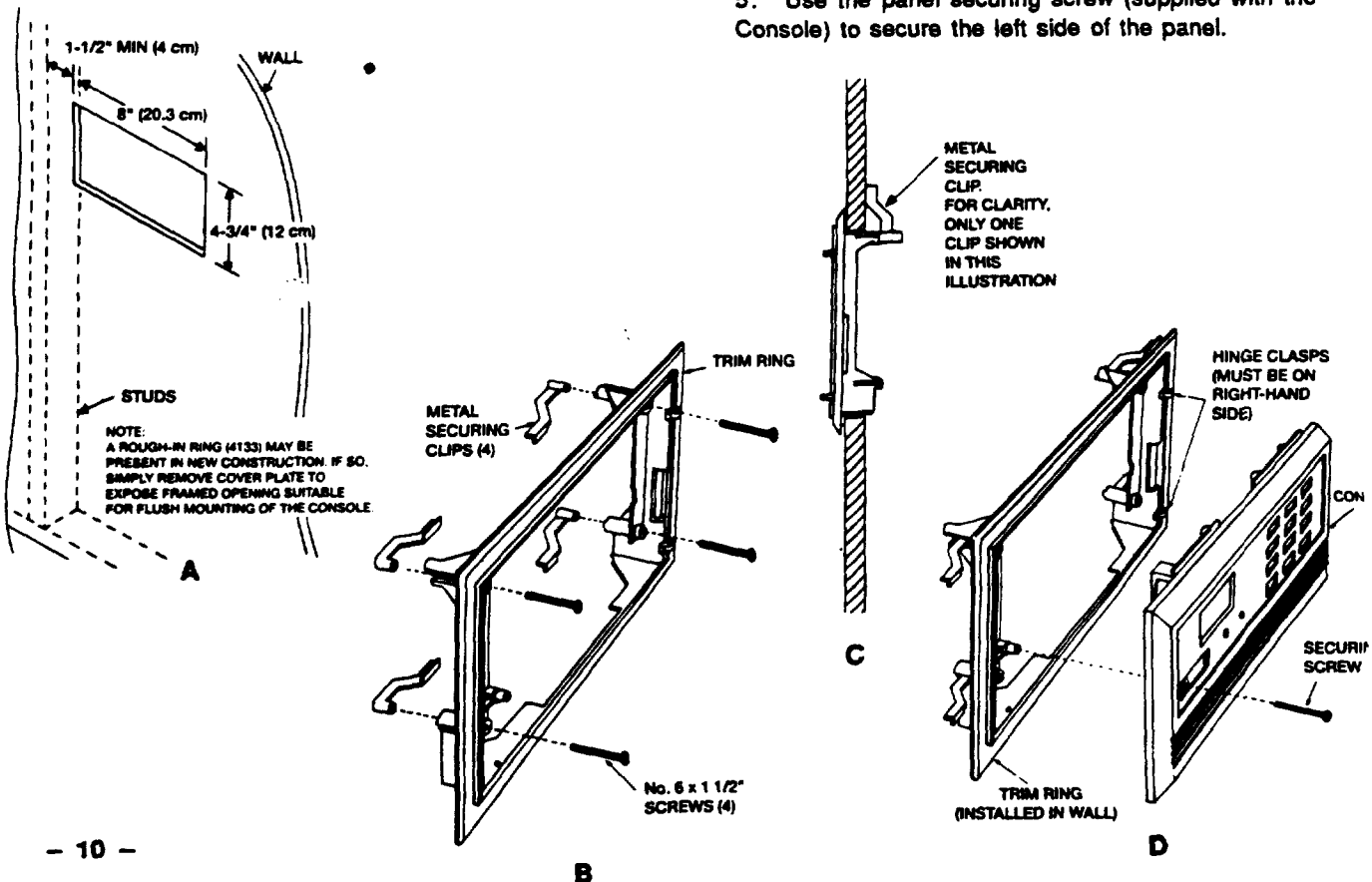

## — POWERING THE SYSTEM —

### PRIMARY POWER

Power to the 4140XM Control panel is supplied by a Plug-In DC Power Pack, 1360, which is rated at 850 mA @ 18 volts DC. The 4130XM and 5130XM Controls are supplied by a 1350 Plug-In DC Power Pack rated at 700mA @18 volts DC. Since these power packs supply unregulated DC, and because they are polarized (+) & (-), caution must be taken when wiring them to the Controls.

### BACK-UP POWER

In the event of an AC power loss, all VISTA XM Controls are supported by a back-up, rechargeable gel cell battery.

### BATTERY STANDBY TABLE

	4130XM/5130XM	4140XM	
AMP-HRS	200 mA 700 mA	400 mA	
1.2	3.0 hrs.	N/U	N/U
4.0	10.0 hrs.	10.0 hrs.	5.7 hrs.
6.0	15.0 hrs.	15.0 hrs.	8.5 hrs.

**NOTE:** The above figures are approximate, and may vary depending upon the age, quality, and capacity of the battery at the time of the AC loss.

### POWER-UP PROCEDURE

1. Wire the 1350 (1360) DC Power Pack first (before the battery), making sure polarity is correct and the terminal strip (or harness) is connected to the Control panel as shown in the SUMMARY OF CONNECTIONS diagrams. Do not plug in at this time.
2. Connect all auxiliary devices, such as consoles, PIRs, etc.
3. Plug the 1350 into an AC outlet. Check that the Auxiliary Voltage measures between 13.5 and 14.0 volts DC. If under 13.5 volts, too much current is being drawn from the Control. See the SPECIFICATIONS section of the *Technical Reference Manual* for the current draw of each device.
4. Connect the battery as shown in the SUMMARY OF CONNECTIONS diagrams. Do not connect the battery if Auxiliary Voltage is below 13.5 volts, as this will prevent the battery from being fully charged.

**CAUTION:** If total current draw is above the maximum auxiliary current available, a 1350 power pack\* must be used to power up to 7 additional remote consoles. If only one console is being used, power additional devices from a separate 12VDC power source (i.e. 488-12).

\* Not allowed for UL installations.

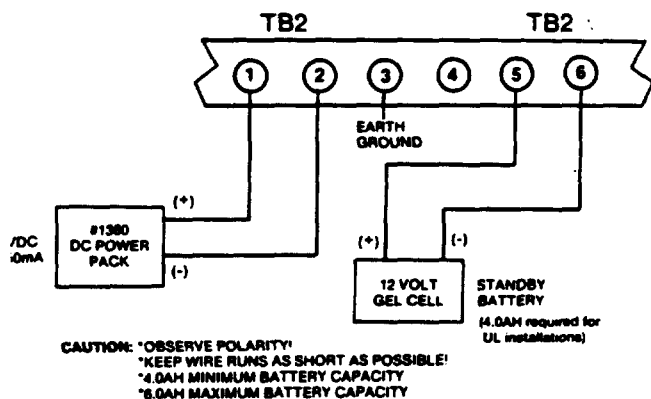

4140XM POWER PACK BATTERY CONNECTIONS

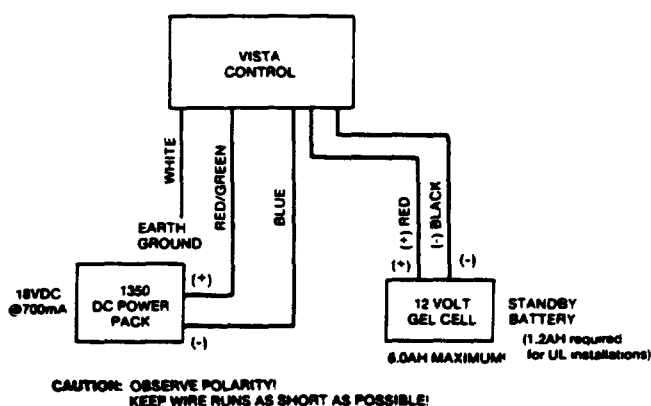

5130XM/4130XM POWER PACK AND BATTERY CONNECTIONS

99

### AUXILIARY DEVICE CURRENT DRAW WORKSHEET

DEVICE	CURRENT	# OF UNITS	TOTAL CURRENT
4137 Console	60 mA		
5137 Console	90 mA		
4146 Keyswitch	20 mA		
675 Ground Start Module	50 mA		
4280 or 4280-8 Receiver	40 mA		
<b>TOTAL *</b>			

\*4130XM/5130XM = 280 mA Max. Aux. current (200 mA Max. for UL Installations)

\*4140XM = 700 mA Max. Aux. current (400 mA for UL Installations)

### POLLING LOOP CURRENT DRAW WORKSHEET

RPM DEVICE	CURRENT	# OF UNITS	TOTAL CURRENT
4139 Contact	1 mA		
4191 Contact	1 mA		
4194 Contact	1 mA		
4192SD Photo Smoke	1 mA		
4192SDT Smoke w/Heat	1 mA		
4192CP Ion Smoke	1 mA		
4275 Dual PIR	1 mA		
4196 Quad PIR	1 mA		
4190 2-Zone RPM	1 mA (LOW) 2 mA (HIGH)		
4208 8-Zone RPM	16 mA		
4280 63 Zone RF	40 mA		
4280-8 8 Zone RF	40 mA		
<b>TOTAL **</b>			

\*\*If the total current draw exceeds 64 mA, a 4197 Loop Extender module must be used.

\*\*If using two 4280s or 4280-8s, you can power one of them from auxiliary power instead of using a 4197 loop extender module.

## V. SYSTEM OPERATION

### — SECURITY ACCESS CODES —

The VISTA XM System allows up to 22 security access codes to be assigned, each identified by a user ID number.

The installer programs an Installer's Code initially as part of the programming procedure, and this code is the only code that permits re-entry into the programming mode (unless \*98 has been previously used to exit the programming mode, see below). The Installer's Code can also be used to perform normal system functions, but cannot assign temporary codes.

The system also provides an Installer Code lock-out feature, which prevents the use of the Installer's Code from re-accessing the Programming mode after the initial programming. This feature is activated by pressing \*98 to exit Programming mode. The only way to access Programming mode once this feature is activated, is by powering down the system and powering up again, and then pressing both the \* and # keys at the same time within 30 seconds of power up. If re-access to Programming mode using the Installer's Code is desired after initial programming, then exit Programming mode by pressing \*99.

The Installer also programs the master security code, which is the code intended for use by the primary user of the system. The master code can then be used to assign up to twenty temporary codes, which can be used by secondary users of the system who do not have a need to know the master code. In addition, the Quick Arm feature can also be programmed, which enables the [#] key to be pressed in lieu of entering the security code when arming the system.

As shipped from the factory, an initial Installer's code and master code is pre-programmed, and can be changed by the installer to any code desired. The pre-programmed codes are as follows:

INSTALLER'S CODE	MASTER CODE
4130XM = 4-1-3-0	All Controls = 1-2-3-4
4140XM = 4-1-4-0	
5130XM = 5-1-3-0	

For additional information about security codes, refer to the *Technical Reference Manual* and/or the *User's Manual*.

### — RECALLING ALARM & TROUBLE MESSAGES —

The system's alarm memory retains all events for a period of 10 days, starting at the time of the first event. Upon expiration of the 10-day period, all history is automatically erased and the alarm memory will reset. The next 10-day cycle will begin when the next event occurs.

Recall by service personnel will display all events that have occurred from the start of the 10-day cycle to the time of recall. Note that Recall will end any 10-day cycle in progress. The LCD display on the 4130XM/4137 console will indicate the number of the zone in which the event occurred (e.g., 01, 02, etc.), accompanied by the word CHECK (trouble), ALARM and, if applicable, FIRE, to describe the type of event that occurred in the displayed zone.

If a 5130XM/5137 is used, an alpha descriptor of the zone will be displayed in addition to its zone number. If more than one event had occurred, the events will be displayed in numerical sequence. Each display will appear for 1-2 seconds, then the next event will be displayed. When all events have been displayed, the displays are repeated.

To display the 10-day history, enter the security code and press the 0 key.

To exit Recall, enter the security code and press the OFF key. All existing memory is erased and the alarm memory is reset. The 10-day cycle will start again only when the next event occurs.

### — KEYPAD FUNCTIONS —

The keypad allows the user to arm and disarm the system, and perform other system functions, such as bypassing zones, view messages from the central station and display zone descriptors. Zone and system conditions (alarm, trouble, bypass) are displayed in the Display Window.

For additional information, refer to the *User's Manual*.

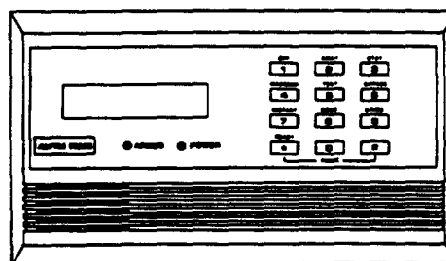

101

## VI. SYSTEM COMMUNICATIONS

The 4171XT-XM Dialer Board is required for polling loop and/or wireless zone expansion, and for office initiated downloading, and is also used to communicate with the central station via dial network telephone line, if that service is desired. The 4171XM can be used if only central station communication and site initiated downloading is desired. The 4171XM does not support system zone expansion or office initiated downloading.

### — COMMUNICATION FORMATS —

#### ADEMCO LOW SPEED

ADEMCO LOW SPEED is a pulsed format which responds to a 1400 Hz handshake and kiss-off, and transmits data with 1900Hz pulse tones @ 10 pulses per second (pps). A typical message consists of two rounds which must be verified by the receiver.

In expanded reporting, two messages are sent, two rounds per message, the first being the account number and alarm code, the second being the zone (or channel) to which the alarm was assigned.

#### SESCO/RADIONICS

Standard and expanded reporting in the SESCO/RADIONICS format is virtually the same as ADEMCO Low Speed except:

1. The handshake and kiss-off frequency is 2300 Hz.
2. The data is transmitted with 1800 Hz pulse tones.
3. The rate of transmission is 20 pps.

#### 4+2 REPORTING

A 4+2 report consists of a 4-digit account number and a 2-digit alarm code, or event code.

4+2 reports can be accomplished in two ways:

1. Either in ADEMCO Low Speed (10 pps), or SESCO/RADIONICS (20 pps) format.
2. Either in standard or expanded zone reporting.

The terms "standard" and "expanded" have a slightly different meaning than previously described. In 4+2, standard zone reporting sends a 4-digit account number followed by a 2-digit code, where the first digit is the ALARM code and the second digit is the channel to which the zone alarm was assigned. Ex. 1 2 3 4 3 9 (code 3, channel 9).

In 4+2 expanded zone reporting a unique 2-digit code for each zone "event" (27 zones max) is reported. A 4-digit account number followed by a 2-digit code is sent, where the first digit is the actual event, such as in ALARM, RESTORE, or TROUBLE, etc., and the second digit of the code represents the "zone" where the event occurred. (but not necessarily the actual zone number). Each code in itself is unique to a specific zone.

**CAUTION:** 1. If the communicator is connected to a telephone line inside a PABX, be sure the PABX has a back-up power supply that can support the PABX for 24 hours. Many PABXs are *not* power backed up and connection to such a PABX will result in a communication failure if power is lost.

2. Refer to the SUMMARY OF CONNECTIONS diagrams for proper line seizure connections.

#### 4+2 EXPRESS

ADEMCO's new express format provides the same information as the 4+2 Expanded format except:

1. The data is transmitted in DTMF (Dual Tone Multi-Frequency, known as "TouchTone", at the rate of 10 characters per second). This greatly decreases the time it takes a report to go through to central station. An average 4+2 Low Speed report might take as long as 20 seconds to complete its report, but 4+2 Express takes under 3 seconds.

2. Two message rounds are eliminated by the use of a checksum digit. Instead of the communicator sending 2 rounds per report, it sends only 1 round with a checksum digit at the end. Doing this also helps in decreasing the time it takes for a report to be sent. (CHECKSUM is explained further at the end of this section).

3. The handshake frequency is 1400 Hz followed by 2300 Hz, and the kiss-off frequency is 1400 Hz.

4. If the installation uses zones 28-64 and this format is selected, events in zones 28-64 will not be transmitted.

#### ADEMCO HIGH SPEED REPORTING

ADEMCO's High Speed format transmits data in DTMF at a rate of 10 characters per second. The handshake frequency is 1400 Hz followed by 2300 Hz, and the kiss-off frequency is 1400 Hz. The message contains 13 digits as follows: A 4-digit account number + eight channels of zone information (1-8 or duress plus 9-15) + one status channel, which identifies the type of events being reported in the eight zone locations. A typical High Speed report will be kissed off in under 5 seconds.

#### LIMITATIONS

1. When using Ademco high speed, remember there are only 15 channels available, plus a duress channel. If more than 15 zones are being used, they will have to share channels.

2. With high speed reporting, channels 9-15 cannot report troubles or bypasses. Use these channels for zones that will not have to report these conditions.



## CONTACT ID REPORTING

This is the only format that can identify all 64 protection zones by their unique zone (Contact) ID numbers, and provides a 1-digit event qualifier and 3-digit, specifically defined event code which quickly identifies the condition being reported.

Contact ID reports in DTMF (Dual Tone Multi-Frequency @ 10 characters per second) and responds to a 1400 Hz followed by 2300 Hz handshake, and a 1400 Hz kissoff. This format also uses checksum instead of two message verification. A complete report takes under 3 seconds.

## ADVISORY

Ademco's new Contact ID reporting is capable of uniquely reporting all 64 zones of information, as well as openings and closings for all 22 users, to central stations equipped with the Ademco 685 receiver using software level 4.4 or higher. 685 software levels below 4.4 cannot support Contact ID reporting. For information regarding updating the 685 receiver, contact Ademco's Technical Support group at 1-800-645-7492.

## VII. PROGRAMMING THE SYSTEM

The system is shipped with a set of pre-programmed values that are designed to meet the needs of many installations. These can be changed by the installer to suit specific needs if desired. In addition, four sets of pre-programmed communication default values can also be loaded by the installer, each set designed for a specific communication format. These too can be changed to suit the needs of a particular installation.

Changes to these pre-programmed values can be programmed directly from the keypad or from a computer terminal using the 4130PC Downloading software, an IBM compatible computer and a HAYES 1200 SMARTMODEM. The following paragraphs describe how to load the various default programming sets. For instructions on making changes to particular programming fields, or for using downloading, refer to the *Technical Reference Manual*.

For alpha Controls, English Language descriptions of the zones and a custom installer message (which appears when the system is ready to arm) can be programmed. Refer to the instructions in the *Technical Reference Manual* for details.

The programming fields are grouped into two sets of addresses. The first set is accessed as soon as programming mode is entered. To access the second set of addresses (indicated on the programming form by a "1" in front of the 2-digit field address), press \*94 while in programming mode. To return to the first set of addresses, press \*99.

To program specific data fields, press [\*] plus the 2-digit field address, then make the required entry. The console will beep when a field has been completely programmed and will automatically display the next data field in numerical order.

To view the contents of a data field, press [#] plus the 2-digit field address. The field's entries will be displayed, but no changes to these entries can be made.

There are five sets of pre-programmed defaults available (one standard, plus four different communication defaults). Any one of these can be loaded into the system's memory by doing the following:

1. Enter programming mode by pressing [\*] and [#] at the same time and within 30 seconds after power is applied. OR Enter the installer code, and press CODE + [0] +[0].
2. Load one of the default programming sets by entering one of the following code sequences:

PRESS	TO LOAD THIS PROGRAMMING SET
*97	Loads standard default values.
*94*80	Standard Low Speed 3+1/4+1
*94*81	Expanded Low Speed 3+1/4+1
*94*82	Ademco High Speed
*94*83	Expanded 4+2

A complete list of the default values can be found in the *Technical Reference Manual*.

To Exit programming mode, press either \*98 or \*99. Use \*98 to prevent re-access to programming mode by installer code method. \*99 allows installer code access to programming mode.

## VIII. TESTING THE SYSTEM

### USING TEST MODE

After the installation is completed, the Security System should be thoroughly tested as follows:

1. With the System in the disarmed state, check that all zones are intact. If DISARMED - Press [\*] to show faults (5137) or NOT READY (4137) is displayed, press the [\*] key to display the descriptors of the faulted zone(s). Restore faulted zone(s) if necessary, so that \*\*\*\*DISARMED\*\*\* READY TO ARM (5137) or READY (4137) is displayed.

2. Enter the security code and press the TEST key. The external sounder (if used) should sound for 3 seconds and then turn off (the system is operating on the back-up battery only at this time).

NOTE 1. The system will not enter the Test mode if the battery voltage is too low, if the battery is not connected, or if any communication messages are waiting to be transmitted.

NOTE 2. As a reminder that the system is in the Test mode, the Console will sound a single beep at 15-second intervals if no protection zones are violated.

NOTE 3. In the Test mode, no alarm reports will be sent to the central station. Also, the external sounder (if used) will not be activated.

### Doors and windows

Open and close each protected door and window in turn. Each action should produce three beeps from the Console. The descriptor for each protection zone will appear on the Console display.

### Motion detectors

Walk in front of any interior motion detectors. Listen for three beeps when the detector senses movement. While it is activated, its descriptor will remain displayed on the Console. Note that wireless PIRs will have a 3 minute lockout between transmissions to conserve battery life.

### Smoke detectors

Follow the test procedure provided by the manufacturer of each smoke detector to ensure that all detectors are operational and are functioning properly.

NOTE: A 2-wire smoke detector display will not clear until the Test mode is exited.

### Turning off TEST mode

Enter the security code and press the OFF key.

### ARMED SYSTEM TEST

**IMPORTANT!** A message will be sent to the central station during the following tests. Notify the central station that a test will be in progress.

NOTE: A display of "COMM. FAILURE" (Alpha consoles) or "FC" (Fixed-Word consoles) indicates a failure to communicate (no Kissoff by the receiver at the central station after the maximum number of transmission attempts is tried).

1. Arm the system and fault one or more zones. Silence alarm sounder(s) each time by entering the code and pressing OFF. Check that Entry/Exit delay zones provide the assigned delay times.

2. Check the keypad-initiated alarms, if programmed in field \*05, by pressing the Panic keys (\* and #, 1 and \*, and/or 3 and #). If the system has been programmed for audible emergency, the console will emit a loud, steady alarm sound. The word ALARM and a descriptor "99" will be displayed for \* and #. (if 1 and \* are pressed, a "95" will be displayed; if 3 and # are pressed, a "96" will be displayed). Silence the alarm by entering the security code and pressing OFF. If the system has been programmed for silent panic, there will be no audible alarms or displays. A report will be sent to the central station, however.

3. Notify the central station that all tests are finished and verify results with them.

### TURNING THE SYSTEM OVER TO THE USER

1. Fully explain the operation of the system to the user by going over each of its functions as well as the User's Manual supplied.

2. In particular, explain the operation of each zone (entry/exit, perimeter, interior, fire, etc.). Be sure the user understands how to operate any emergency feature(s) programmed into the system.

**IMPORTANT!** In the spaces provided in the User's Manual, record the Entry and Exit Delay times, and those functions that have been programmed into the available pairs of PANIC keys (\* and #, 1 and \*, 3 and #).

3. Make sure the user understands the importance of testing the system at least weekly, following the procedure provided in the User's Manual.

## IX. SPECIFICATIONS

### 4140XM CONTROL

**Physical:** Width: 12 inches (305mm)  
Height: 12 inches (305mm)  
Depth: 3 inches (76mm)

#### Electrical:

**VOLTAGE INPUT:** 18VDC, 850 mA max. (from plug-in Power Pack, Ademco No. 1360)

**RECHARGEABLE BACK-UP BATTERY:** 12VDC, 4 AH (Gel type)

**ALARM SOUNDER OUTPUT:** Wet contact relay (2.8A max. contact rating @ 28VDC). Can drive 12V motor driven bells (100 mA each) - AMSECO MSB10G or ABB1031.

**AUXILIARY POWER OUTPUT:** 11.5 - 14.0VDC  
700 mA for non-UL installations  
400 mA max. for UL installations

**STANDBY:** 5.7 hours with Auxiliary load of 700 mA using 4 AH Battery. 8.5 hours with Auxiliary load of 400 mA using 4 AH Battery

#### Fuses:

**Battery Fuse:** 3A Slo Blo (Ademco No. 90-28)  
**Auxiliary Power:** 1A (Ademco No. 90-29)  
**Alarm Relay Power:** 3A Slo Blo (Ademco No. 90-28)

### DIGITAL COMMUNICATION INTERFACE BOARD (4171XT-XM)

**Physical:** 5-3/4" (14.6 cm) x 3-1/8" (8.25 cm) x 7/8" (2.2 cm) (approx.).

#### Functional:

##### FORMATS SUPPORTED:

**ADEMCO LOW SPEED,** 10 pulses/sec. 1900 Hz Data Tone, 1400 Hz ACK/KISSOFF.

**SESCOA,** 20 pulses/sec, 1800 Hz Data Tone, 2300 Hz ACK/KISSOFF, Variable Interdigit Timing.

**RADIONICS,** 20 pulses/sec, 1800 Hz Data Tone, 2300 Hz ACK/KISSOFF, Fixed Interdigit Timing.

##### ADEMCO CONTACT ID

**LINE SEIZE:** Double Pole

**RINGER EQUIVALENCE:** 0.7B

**FCC REGISTRATION NO.:** AC 398U-68192-AL-E.

### 5130XM/4130XM CONTROLS

**Physical:** Width: 8.4 inches (21.3cm)  
Height: 4.75 inches (12.1 cm)  
Depth: 1.1 inches (2.8 cm)

#### Electrical:

**VOLTAGE INPUT:** 18VDC (from plug-in Power Pack, Ademco No. 1350), 700 mA max.

**RECHARGEABLE BACK-UP BATTERY:** 12VDC, 1.2 AH, Ademco No. 484 (YUASA NP 1212). (Alternatively, a 4 AH Ademco No. 486 may be used\*).

**ALARM SOUNDER:** Built-in piezoelectric sounder, 85 db at 10 feet. Sound produced is selectable as "steady" (in compliance with UL 85 db output requirement) or "sweeping" (for non-UL usage).

Optional external 12V Piezoelectric alarm sounder (100 mA max.). (Ademco No. 740 or BRK PA400B).

Optional 12V motor-driven Bell (100 ma max.). (AMSECO MSB10-G or ABB-1031).

Optional dry contact relay (2.8A max. contact rating @28VDC). Ademco No. 4148\*. Can drive No. 719 or No. 702 Siren.

**AUXILIARY POWER OUTPUT:** 10.2-13.8VDC  
280 mA for non-UL installations  
200 mA max. for UL installations

**STANDBY:** 2.5 Hours with 200 mA standby current load. 5 Hours with no external current load.  
\*Not available in a UL installation.

### 5137/4137 REMOTE CONSOLES

**Physical:** Width: 8.4 inches (213 mm)  
Height: 4.75 inches (121 mm)  
Depth: 1.1 inches (28 mm)

#### Electrical:

**Voltage Input:** 12VDC

**Current Drain:** 60 mA (4137) continuous  
90 mA (5137) with back lighting

#### Interface Wiring:

**RED:** 12VDC input (+) - auxiliary power

**BLUE:** 18VDC input (+) - from optional 1350 or 1360 Power Pack\*

**GREEN:** Data In

**YELLOW:** Data Out

**BLACK:** Ground and (-) connection from optional 1350 or 1360 Power Pack.

\* Not permitted for UL installations.

#### TO THE INSTALLER

Regular maintenance and inspection (at least annually) by the installer and frequent testing by the user are vital to continuous satisfactory operation of any alarm system.

The installer should assume the responsibility of developing and offering a regular maintenance program to the user as well as acquainting the user with the proper operation and limitations of the alarm system and its component parts. Recommendations must be included for a specific program of frequent testing (at least weekly) to insure the system's proper operation at all times.

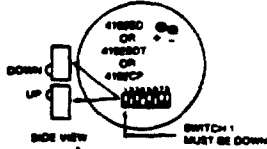

DEVICE ADDRESS NUMBER	DIP SWITCH POSITION							
	3	4	5	6	7	8	9	0
10	on	on	UP	on	UP	on		
11	on	on	UP	on	UP	on		
12	on	on	UP	on	UP	on		
13	on	on	UP	on	UP	on		
14	on	on	UP	on	UP	on		
15	on	on	UP	on	UP	on		
16	on	on	UP	on	UP	on		
17	on	on	UP	on	UP	on		
18	on	on	UP	on	UP	on		
19	on	on	UP	on	UP	on		
20	on	on	UP	on	UP	on		
21	on	on	UP	on	UP	on		
22	on	on	UP	on	UP	on		
23	on	on	UP	on	UP	on		
24	on	on	UP	on	UP	on		
25	on	on	UP	on	UP	on		
26	on	on	UP	on	UP	on		
27	on	on	UP	on	UP	on		
28	on	on	UP	on	UP	on		
29	on	on	UP	on	UP	on		
30	on	on	UP	on	UP	on		
31	on	on	UP	on	UP	on		
32	on	on	UP	on	UP	on		
33	on	on	UP	on	UP	on		
34	on	on	UP	on	UP	on		
35	on	on	UP	on	UP	on		
36	on	on	UP	on	UP	on		
37	on	on	UP	on	UP	on		
38	on	on	UP	on	UP	on		
39	on	on	UP	on	UP	on		
40	on	on	UP	on	UP	on		
41	on	on	UP	on	UP	on		
42	on	on	UP	on	UP	on		
43	on	on	UP	on	UP	on		
44	on	on	UP	on	UP	on		
45	on	on	UP	on	UP	on		
46	on	on	UP	on	UP	on		
47	on	on	UP	on	UP	on		
48	on	on	UP	on	UP	on		
49	on	on	UP	on	UP	on		
50	on	on	UP	on	UP	on		
51	on	on	UP	on	UP	on		
52	on	on	UP	on	UP	on		
53	on	on	UP	on	UP	on		
54	on	on	UP	on	UP	on		
55	on	on	UP	on	UP	on		
56	on	on	UP	on	UP	on		
57	on	on	UP	on	UP	on		
58	on	on	UP	on	UP	on		
59	on	on	UP	on	UP	on		
60	on	on	UP	on	UP	on		
61	on	on	UP	on	UP	on		
62	on	on	UP	on	UP	on		
63	on	on	UP	on	UP	on		

Address 64: See 4198

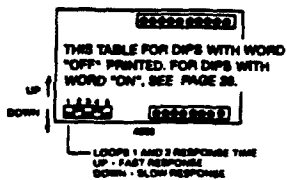

DEVICE ADDRESS NUMBER	DIP SWITCH POSITION				
	2	3	4	5	6
10-16	on	on	on	UP	
17-24	on	on	UP	UP	
25-32	on	on	UP	UP	
33-40	on	UP	on	on	
41-48	on	UP	on	UP	
49-56	on	UP	UP	on	
57-64	on	UP	UP	UP	

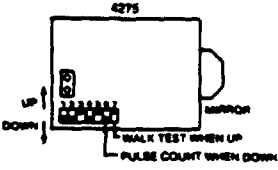

THIS TABLE FOR DIPS WITH WORD "OFF" PRINTED. FOR DIPS WITH WORD "ON", SEE PAGE 26.

DEVICE ADDRESS NUMBER	DIP SWITCH POSITION				
	1	2	3	4	5
10	on	UP	on	UP	on
11	on	UP	on	UP	on
12	on	UP	on	UP	on
13	on	UP	on	UP	on
14	on	UP	on	UP	on
15	on	UP	on	UP	on
16	UP	on	on	on	on
17	UP	on	on	on	UP
18	UP	on	on	UP	on
19	UP	on	on	UP	on
20	UP	on	on	on	on

DEVICE ADDRESS NUMBER	DIP SWITCH POSITION				
	1	2	3	4	5
21	UP	on	UP	on	UP
22	UP	on	UP	on	UP
23	UP	on	UP	on	UP
24	UP	UP	on	on	on
25	UP	UP	on	on	on
26	UP	UP	on	UP	on
27	UP	UP	on	UP	on
28	UP	UP	UP	on	on
29	UP	UP	UP	on	on
30	UP	UP	UP	UP	on
31	UP	UP	UP	UP	UP

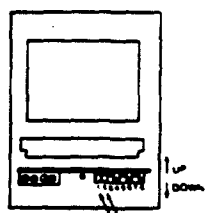

TRANSMITTER	DIP SWITCH SETTINGS							
	3	4	5	6	7	8	9	0
10	UP	UP	on	UP	on	UP		
11	UP	UP	on	UP	on	UP		
12	UP	UP	on	UP	on	UP		
13	UP	UP	on	UP	on	UP		
14	UP	UP	on	UP	on	UP		
15	UP	UP	on	UP	on	UP		
16	UP	UP	on	UP	on	UP		
17	UP	UP	on	UP	on	UP		
18	UP	UP	on	UP	on	UP		
19	UP	UP	on	UP	on	UP		
20	UP	UP	on	UP	on	UP		
21	UP	UP	on	UP	on	UP		
22	UP	UP	on	UP	on	UP		
23	UP	UP	on	UP	on	UP		
24	UP	UP	on	UP	on	UP		
25	UP	UP	on	UP	on	UP		
26	UP	UP	on	UP	on	UP		
27	UP	UP	on	UP	on	UP		
28	UP	UP	on	UP	on	UP		
29	UP	UP	on	UP	on	UP		
30	UP	UP	on	UP	on	UP		
31	UP	UP	on	UP	on	UP		
32	on	UP	UP	UP	UP	UP		
33	on	UP	UP	UP	UP	UP		
34	on	UP	UP	UP	UP	UP		
35	on	UP	UP	UP	UP	UP		
36	on	UP	UP	UP	UP	UP		
37	on	UP	UP	UP	UP	UP		

TRANSMITTER	DIP SWITCH SETTINGS							
	3	4	5	6	7	8	9	0
10	on	UP	UP	on	on	UP		
11	on	UP	UP	on	on	UP		
12	on	UP	UP	on	on	UP		
13	on	UP	UP	on	on	UP		
14	on	UP	UP	on	on	UP		
15	on	UP	UP	on	on	UP		
16	on	UP	UP	on	on	UP		
17	on	UP	UP	on	on	UP		
18	on	UP	UP	on	on	UP		
19	on	UP	UP	on	on	UP		
20	on	UP	UP	on	on	UP		
21	on	UP	UP	on	on	UP		
22	on	UP	UP	on	on	UP		
23	on	UP	UP	on	on	UP		
24	on	UP	UP	on	on	UP		
25	on	UP	UP	on	on	UP		
26	on	UP	UP	on	on	UP		
27	on	UP	UP	on	on	UP		
28	on	UP	UP	on	on	UP		
29	on	UP	UP	on	on	UP		
30	on	UP	UP	on	on	UP		
31	on	UP	UP	on	on	UP		
32	on	UP	UP	on	on	UP		
33	on	UP	UP	on	on	UP		
34	on	UP	UP	on	on	UP		
35	on	UP	UP	on	on	UP		
36	on	UP	UP	on	on	UP		
37	on	UP	UP	on	on	UP		

Address 64: See 4198

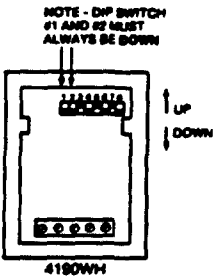

THIS TABLE FOR DIPS WITH WORD "OFF" PRINTED. FOR DIPS WITH WORD "ON", SEE PAGE 26.

DEVICE ADDRESS NUMBER	DIP SWITCH POSITION					
	3	4	5	6	7	8
10	on	on	UP	on	UP	on
11	on	on	UP	on	UP	on
12	on	on	UP	on	UP	on
13	on	on	UP	on	UP	on
14	on	on	UP	on	UP	on
15	on	on	UP	on	UP	on
16	on	on	UP	on	UP	on
17	on	on	UP	on	UP	on
18	on	on	UP	on	UP	on
19	on	on	UP	on	UP	on
20	on	on	UP	on	UP	on
21	on	on	UP	on	UP	on
22	on	on	UP	on	UP	on
23	on	on	UP	on	UP	on
24	on	on	UP	on	UP	on
25	on	on	UP	on	UP	on
26	on	on	UP	on	UP	on
27	on	on	UP	on	UP	on
28	on	on	UP	on	UP	on
29	on	on	UP	on	UP	on
30	on	on	UP	on	UP	on
31	on	on	UP	on	UP	on
32	UP	on	on	on	on	on
33	UP	on	on	on	on	on
34	UP	on	on	on	on	on
35	UP	on	on	on	on	on
36	UP	on	on	on	on	on
37	UP	on	on	on	on	on

DEVICE ADDRESS NUMBER	DIP SWITCH POSITION					
	3	4	5	6	7	8
38	UP	on	on	UP	UP	on
39	UP	on	on	UP	UP	on
40	UP	on	on	UP	UP	on
41	UP	on	on	UP	UP	on
42	UP	on	on	UP	UP	on
43	UP	on	on	UP	UP	on
44	UP	on	on	UP	UP	on
45	UP	on	on	UP	UP	on
46	UP	on	on	UP	UP	on
47	UP	on	on	UP	UP	on
48	UP	on	on	UP	UP	on
49	UP	on	on	UP	UP	on
50	UP	on	on	UP	UP	on
51	UP	on	on	UP	UP	on
52	UP	on	on	UP	UP	on
53	UP	on	on	UP	UP	on
54	UP	on	on	UP	UP	on
55	UP	on	on	UP	UP	on
56	UP	on	on	UP	UP	on
57	UP	on	on	UP	UP	on
58	UP	on	on	UP	UP	on
59	UP	on	on	UP	UP	on
60	UP	on	on	UP	UP	on
61	UP	on	on	UP	UP	on
62	UP	on	on	UP	UP	on
63	UP	on	on	UP	UP	on

Address 64: See 4198

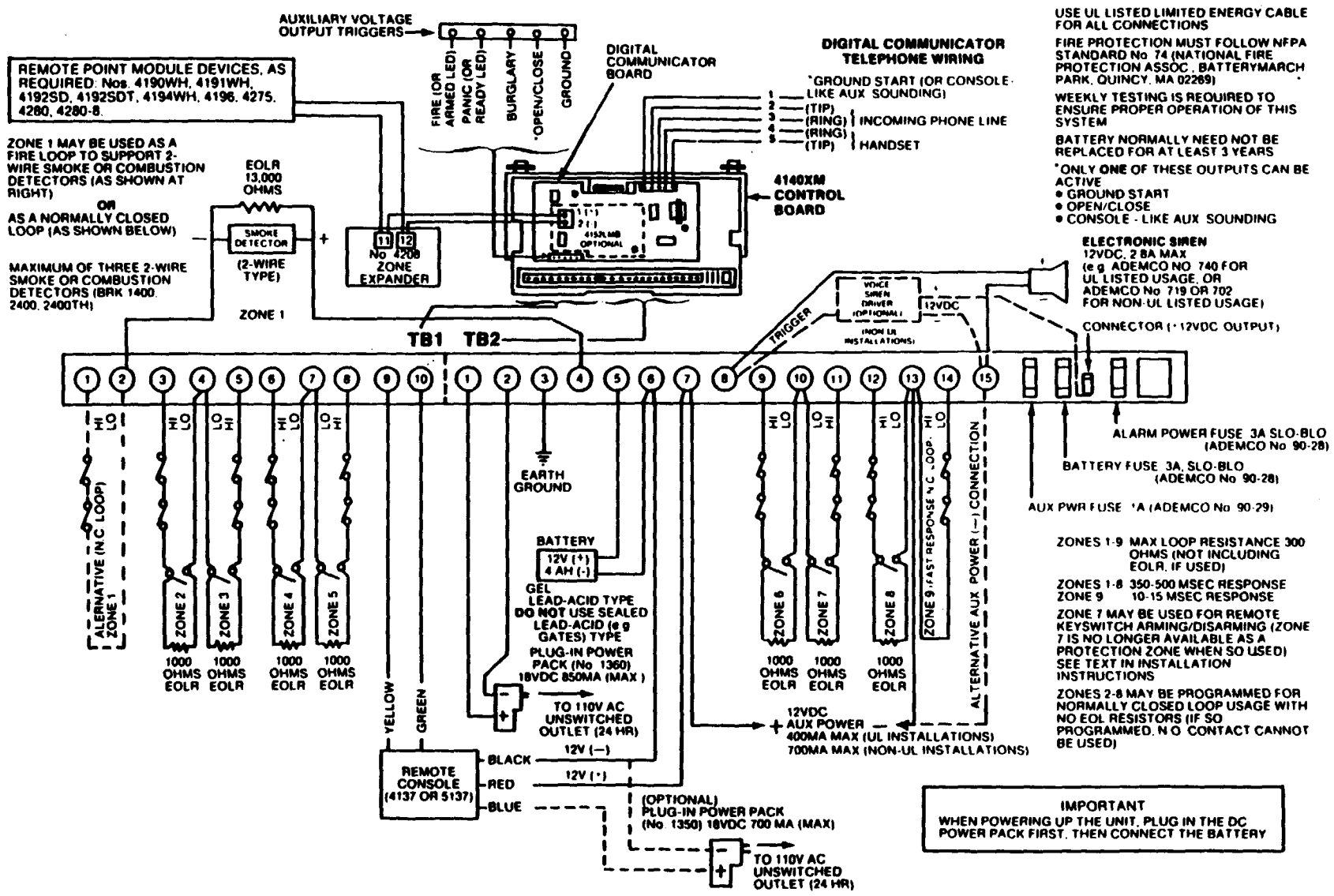

**4140XM SUMMARY OF CONNECTIONS**

107

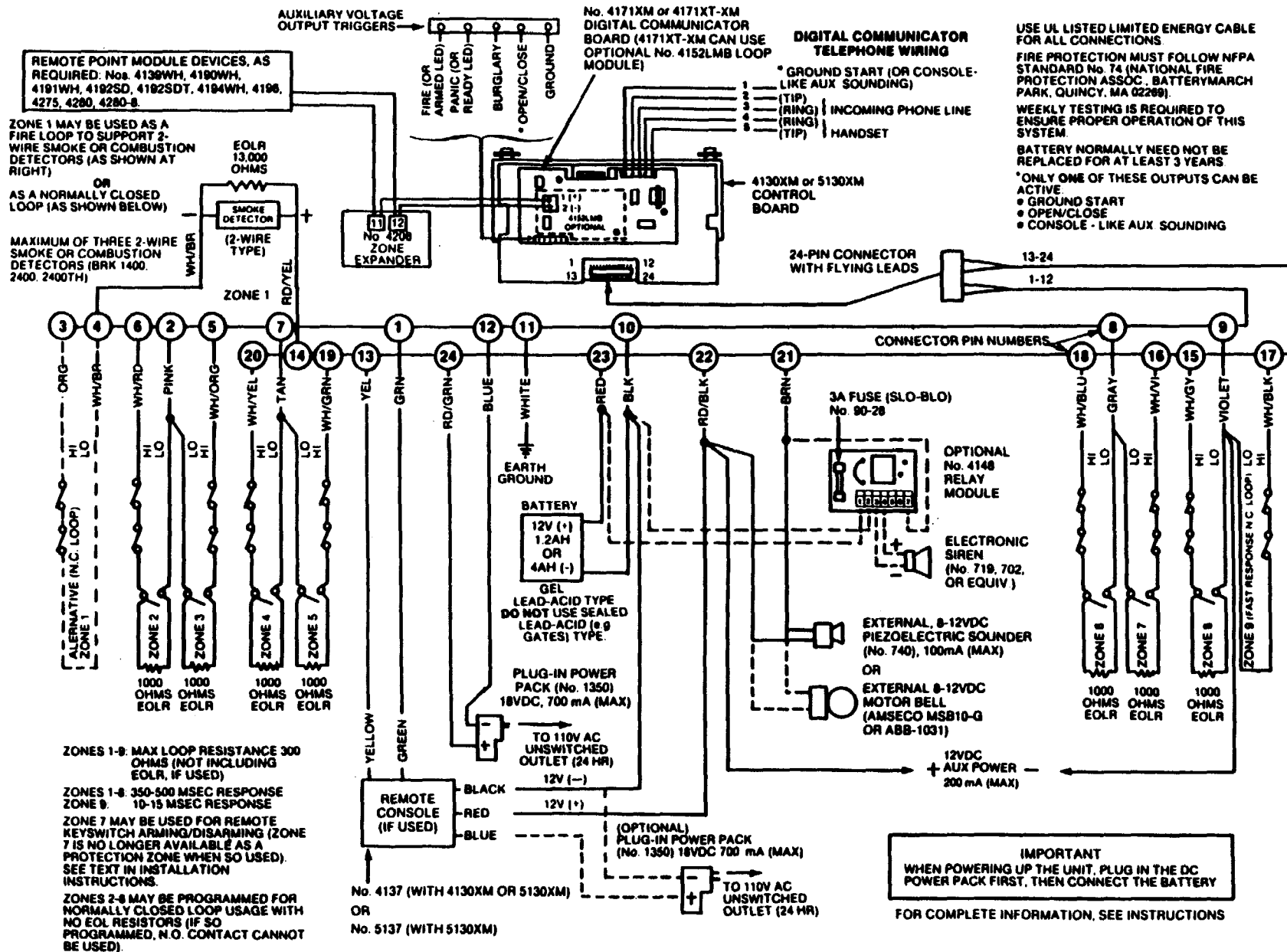

**4130XM/5130XM SUMMARY OF CONNECTIONS**

**"FEDERAL COMMUNICATIONS COMMISSION (FCC) STATEMENT"**

This equipment has been tested to FCC requirements and has been found acceptable for use. The FCC requires the following statement for your information:

This equipment generates and uses radio frequency energy and if not installed and used properly, that is, in strict accordance with the manufacturer's instructions, may cause interference to radio and television reception. It has been type tested and found to comply with the limits for a Class B computing device in accordance with the specifications in Subpart J of Part 15 of FCC Rules, which are designed to provide reasonable protection against such interference in a residential installation. However, there is no guarantee that interference will not occur in a particular installation. If this equipment does cause interference to radio or television reception, which can be determined by turning the equipment off and on, the user is encouraged to try to correct the interference by one or more of the following measures:

- If using an indoor antenna, have a quality outdoor antenna installed.
- Reorient the receiving antenna until interference is reduced or eliminated.
- Move the receiver away from the control/communicator.
- Move the antenna leads away from any wire runs to the control/communicator.
- Plug the control/communicator into a different outlet so that it and the receiver are on different branch circuits.

If necessary, the user should consult the dealer or an experienced radio/television technician for additional suggestions.

The user or installer may find the following booklet prepared by the Federal Communications Commission helpful:

**"Interference Handbook"**

This booklet is available from the U.S. Government Printing Office, Washington, DC 20402. Stock No. 004-000-00450-7.

The user shall not make any changes or modifications to the equipment unless authorized by the Installation Instructions or User's Manual. Unauthorized changes or modifications could void the user's authority to operate the equipment.

— NOTES —

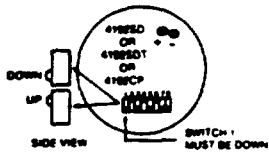

DEVICE ADDRESS NUMBER	DIP SWITCH POSITION							
	3	4	5	6	7	8	9	10
10	on	on	UP	on	UP	on		
11	on	on	UP	on	UP	UP		
12	on	on	UP	on	UP	on		
13	on	on	UP	on	UP	on		
14	on	on	UP	on	UP	UP		
15	on	on	UP	on	UP	UP		
16	on	on	UP	on	UP	UP		
17	on	on	UP	on	UP	UP		
18	on	on	UP	on	UP	UP		
19	on	on	UP	on	UP	UP		
20	on	on	UP	on	UP	UP		
21	on	on	UP	on	UP	UP		
22	on	on	UP	on	UP	UP		
23	on	on	UP	on	UP	UP		
24	on	on	UP	on	UP	UP		
25	on	on	UP	on	UP	UP		
26	on	on	UP	on	UP	UP		
27	on	on	UP	on	UP	UP		
28	on	on	UP	on	UP	UP		
29	on	on	UP	on	UP	UP		
30	on	on	UP	on	UP	UP		
31	on	on	UP	on	UP	UP		
32	on	on	UP	on	UP	UP		
33	on	on	UP	on	UP	UP		
34	on	on	UP	on	UP	UP		
35	on	on	UP	on	UP	UP		
36	on	on	UP	on	UP	UP		
37	on	on	UP	on	UP	UP		
38	on	on	UP	on	UP	UP		
39	on	on	UP	on	UP	UP		
40	on	on	UP	on	UP	UP		
41	on	on	UP	on	UP	UP		
42	on	on	UP	on	UP	UP		
43	on	on	UP	on	UP	UP		
44	on	on	UP	on	UP	UP		
45	on	on	UP	on	UP	UP		
46	on	on	UP	on	UP	UP		
47	on	on	UP	on	UP	UP		
48	on	on	UP	on	UP	UP		
49	on	on	UP	on	UP	UP		
50	on	on	UP	on	UP	UP		
51	on	on	UP	on	UP	UP		
52	on	on	UP	on	UP	UP		
53	on	on	UP	on	UP	UP		
54	on	on	UP	on	UP	UP		
55	on	on	UP	on	UP	UP		
56	on	on	UP	on	UP	UP		
57	on	on	UP	on	UP	UP		
58	on	on	UP	on	UP	UP		
59	on	on	UP	on	UP	UP		
60	on	on	UP	on	UP	UP		
61	on	on	UP	on	UP	UP		
62	on	on	UP	on	UP	UP		
63	on	on	UP	on	UP	UP		

Address 64: See 4196

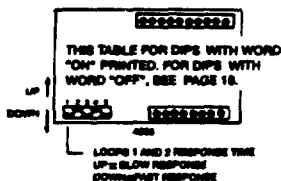

DEVICE ADDRESS NUMBER	DIP SWITCH POSITION			
	2	3	4	5
10-19	UP	UP	UP	on
17-24	UP	UP	on	UP
25-32	UP	UP	on	on
33-40	UP	on	UP	UP
41-48	UP	on	UP	on
49-56	UP	on	on	UP
57-64	UP	on	on	on

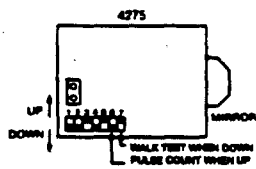

THIS TABLE FOR DIPS WITH WORD "ON" PRINTED. FOR DIPS WITH WORD "OFF", SEE PAGE 18.

DEVICE ADDRESS NUMBER	DIP SWITCH POSITION				
	1	2	3	4	5
10	UP	on	UP	on	UP
11	UP	on	UP	on	on
12	UP	on	on	UP	UP
13	UP	on	on	UP	on
14	UP	on	on	on	UP
15	UP	on	UP	UP	UP
16	on	UP	UP	UP	on
17	on	UP	UP	on	on
18	on	UP	UP	on	on
19	on	UP	on	UP	UP
20	on	UP	on	UP	UP

DEVICE ADDRESS NUMBER	DIP SWITCH POSITION				
	1	2	3	4	5
21	on	UP	on	UP	on
22	on	UP	on	on	UP
23	on	UP	on	on	on
24	on	on	UP	UP	UP
25	on	on	UP	UP	on
26	on	on	UP	on	UP
27	on	on	on	UP	on
28	on	on	on	UP	UP
29	on	on	on	UP	on
30	on	on	on	on	UP
31	on	on	on	on	on

TRANSMITTER	DIP SWITCH SETTINGS							
	3	4	5	6	7	8	9	10
10	UP	UP	on	UP	on	UP		
11	UP	UP	on	UP	on	on		
12	UP	UP	on	on	UP	UP		
13	UP	UP	on	on	on	UP		
14	UP	UP	on	on	on	UP		
15	UP	UP	on	on	on	on		
16	UP	on	UP	UP	UP	UP		
17	UP	on	UP	UP	UP	on		
18	UP	on	UP	UP	on	UP		
19	UP	on	UP	UP	on	on		
20	UP	on	UP	on	UP	UP		
21	UP	on	UP	on	on	UP		
22	UP	on	UP	on	on	UP		
23	UP	on	UP	on	on	on		
24	UP	on	on	UP	UP	UP		
25	UP	on	on	UP	UP	on		
26	UP	on	on	UP	on	UP		
27	UP	on	on	on	UP	on		
28	UP	on	on	on	UP	UP		
29	UP	on	on	on	UP	on		
30	UP	on	on	on	on	UP		
31	UP	on	on	on	on	on		
32	on	UP	UP	UP	UP	UP		
33	on	UP	UP	UP	UP	on		
34	on	UP	UP	UP	on	UP		
35	on	UP	UP	UP	on	on		
36	on	UP	UP	on	UP	UP		
37	on	UP	UP	on	UP	on		

TRANSMITTER	DIP SWITCH SETTINGS							
	3	4	5	6	7	8	9	10
38	on	UP	UP	on	on	on		
39	on	UP	UP	on	on	on		
40	on	UP	on	UP	UP	UP		
41	on	UP	on	UP	UP	on		
42	on	UP	on	UP	on	UP		
43	on	UP	on	UP	on	on		
44	on	UP	on	on	UP	UP		
45	on	UP	on	on	UP	on		
46	on	UP	on	on	on	UP		
47	on	on	UP	on	on	on		
48	on	on	UP	UP	UP	UP		
49	on	on	UP	UP	UP	on		
50	on	on	UP	UP	on	UP		
51	on	on	UP	on	UP	on		
52	on	on	UP	on	UP	UP		
53	on	on	UP	on	UP	on		
54	on	on	UP	on	on	UP		
55	on	on	UP	on	on	on		
56	on	on	UP	on	on	UP	UP	
57	on	on	UP	on	on	UP	on	
58	on	on	UP	on	on	UP	UP	
59	on	on	UP	on	on	on	on	
60	on	on	UP	on	on	on	UP	
61	on	on	UP	on	on	UP	on	
62	on	on	UP	on	on	on	UP	
63	on	on	UP	on	on	on	on	

Address 64: See 4196

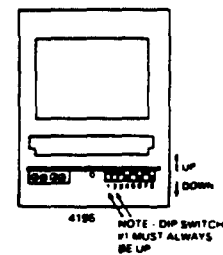

NOTE - DIP SWITCH #1 MUST ALWAYS BE UP

DEVICE ADDRESS NUMBER	DIP SWITCH POSITION					
	3	4	5	6	7	8
10	UP	UP	on	UP	on	UP
11	UP	UP	on	UP	on	on
12	UP	UP	on	on	UP	UP
13	UP	UP	on	on	on	UP
14	UP	UP	on	on	on	on
15	UP	on	UP	UP	UP	UP
16	UP	on	UP	UP	UP	on
17	UP	on	UP	UP	UP	on
18	UP	on	UP	UP	on	UP
19	UP	on	UP	UP	on	on
20	UP	on	UP	on	UP	UP
21	UP	on	UP	on	on	UP
22	UP	on	UP	on	on	UP
23	UP	on	UP	on	on	on
24	UP	on	on	UP	UP	UP
25	UP	on	on	UP	UP	on
26	UP	on	on	UP	on	UP
27	UP	on	on	UP	on	on
28	UP	on	on	on	UP	UP
29	UP	on	on	on	UP	on
30	UP	on	on	on	on	UP
31	UP	on	on	on	on	on
32	on	UP	UP	UP	UP	UP
33	on	UP	UP	UP	UP	on
34	on	UP	UP	UP	on	UP
35	on	UP	UP	on	UP	UP
36	on	UP	UP	on	UP	on

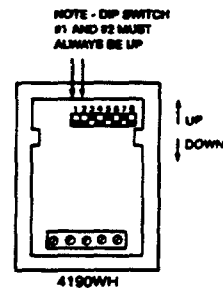

THIS TABLE FOR DIPS WITH WORD "ON" PRINTED. FOR DIPS WITH WORD "OFF", SEE PAGE 18.

DEVICE ADDRESS NUMBER	DIP SWITCH POSITION					
	3	4	5	6	7	8
38	on	UP	UP	on	on	UP
39	on	UP	UP	on	on	on
40	on	UP	on	UP	UP	UP
41	on	UP	on	UP	UP	on
42	on	UP	on	UP	on	UP
43	on	UP	on	UP	on	on
44	on	UP	on	on	UP	UP
45	on	UP	on	on	UP	on
46	on	UP	on	on	on	UP
47	on	UP	on	on	on	UP
48	on	UP	on	on	on	UP
49	on	UP	on	on	on	UP
50	on	UP	on	on	on	UP
51	on	UP	on	on	on	UP
52	on	UP	on	on	on	UP
53	on	UP	on	on	on	UP
54	on	UP	on	on	on	UP
55	on	UP	on	on	on	UP
56	on	UP	on	on	on	UP
57	on	UP	on	on	on	UP
58	on	UP	on	on	on	UP
59	on	UP	on	on	on	UP
60	on	UP	on	on	on	UP
61	on	UP	on	on	on	UP
62	on	UP	on	on	on	UP
63	on	UP	on	on	on	UP

Address 64: See 4196



**WARNING**  
**THE LIMITATIONS OF THIS ALARM SYSTEM**

While this system is an advanced design security system, it does not offer guaranteed protection against burglary, fire or other emergency. An alarm system, whether commercial or residential, is subject to compromise or failure to warn for a number of reasons. For example:

- Intruders may gain access through unprotected openings or have the technical sophistication to bypass an alarm sensor or disconnect an alarm warning device.
- Intrusion detectors (e.g. passive infrared detectors), smoke detectors, and many other sensing devices will not work without power. Battery operated devices will not work without batteries, with dead batteries, or if the batteries are not put in properly. Devices powered solely by AC will not work if their AC power supply is cut off for any reason, however briefly.
- Signals sent by wireless transmitters may be blocked or reflected by metal before they reach the alarm receiver. Even if the signal path has been recently checked during a weekly test, blockage can occur if a metal object is moved into the path.
- A user may not be able to reach a panic or emergency button quickly enough.
- While smoke detectors have played a key role in reducing residential fire deaths in the United States, they may not activate or provide early warning for a variety of reasons in as many as 35% of all fires, according to data published by the Federal Emergency Management Agency. Some of the reasons smoke detectors used in conjunction with this System may not work are as follows. Smoke detectors may have been improperly installed and positioned. Smoke detectors may not sense fires that start where smoke cannot reach the detectors, such as in chimneys, in walls, or roofs, or on the other side of closed doors. Smoke detectors also may not sense a fire on another level of a residence or building. A second floor detector, for example, may not sense a first floor or basement fire. Moreover, smoke detectors have sensing limitations. No smoke detector can sense every kind of fire every time. In general, detectors may not always warn about fires caused by carelessness and safety hazards like smoking in bed, violent explosions, escaping gas, improper storage or flammable materials, overloaded electrical circuits, children playing with matches, or arson. Depending on the nature of the fire and/or the location of the smoke detectors, the detector, even if it operates as anticipated, may not provide sufficient warning to allow all occupants to escape in time to prevent injury or death.
- Passive Infrared Motion Detectors can only detect intrusion within the designed ranges as diagrammed in their installation manual. Passive Infrared Detectors do not provide volumetric area protection. They do create multiple beams of protection, and intrusion can only be detected in unobstructed areas covered by the beams. They cannot detect motion or intrusion that takes place behind walls, ceilings, floors, closed doors, glass partitions, glass doors, or windows. Mechanical tampering, masking, painting or spraying of any material on the mirrors, windows or any part of the optical system can reduce their detection ability. Passive Infrared Detectors sense changes in temperature; however, as the ambient temperature of the protected area approaches the temperature range of 90° to 150°F, the detection performance can decrease.
- Alarm warning devices such as sirens, bells or horns may not alert people or wake up sleepers who are located on the other side of a closed or partly open doors. If warning device sound on a different level of the residence from the bedrooms, then they are less likely to waken or alert people inside the bedrooms. Even persons who are awake may not hear the warning if the alarm is muffle by noise from a stereo, air conditioner or other appliances, or by passing traffic. Finally, alarm warning devices, however loud, may not warn hearing-impaired people or waken deep sleepers.

Telephone lines needed to transmit alarm signals from a premises to a central monitoring station may be out of service or temporarily out of service. Telephone lines are also subject to compromise by sophisticated intruders.

- Even if the system responds to the emergency as intended, however, occupants may have insufficient time to protect themselves from the emergency situation. In the case of a monitored alarm system, authorities may not respond appropriately.
- This equipment, like other electrical devices, is subject to component failure. Even though this equipment is designed to last as long as 10 years, the electronic components could fail at any time.

The most common cause of an alarm system not functioning when an intrusion or fire occurs is inadequate maintenance. This alarm system should be tested weekly to make sure all sensors are working properly. Installing an alarm system may make one eligible for lower insurance rates, but an alarm system is not a substitute for insurance. Homeowners, property owners and renters should continue to act prudently in protecting themselves and continue to insure their lives and property.

We continue to develop new and improved protection devices. Users of alarm systems owe it to themselves and their loved ones to learn about these developments.

**ADEMCO  
Limited Warranty**

Alarm Device Manufacturing Company, a Division of Pittway Corporation, and its divisions, subsidiaries and affiliates ("Seller"), 165 Eileen Way, Syosset, New York 11791, warrants its products to be in conformance with its own plans and specifications and to be free from defects in materials and workmanship under normal use and service for 18 months from the date stamp control on the product or, for products not having an Ademco date stamp, for 12 months from date of original purchase unless the installation instructions or catalog sets forth a shorter period, in which case the shorter period shall apply. Seller's obligation shall be limited to repairing or replacing, at its option, free of charge for materials or labor, any part which is proved not in compliance with Seller's specifications or proves defective in materials or workmanship under normal use and service. Seller shall have no obligation under this Limited Warranty or otherwise if the product is altered or improperly repaired or serviced by anyone other than Ademco factory service. For warranty service, return product transportation prepaid, to Ademco Factory Service, 165 Eileen Way, Syosset, New York 11791.

THERE ARE NO WARRANTIES, EXPRESS OR IMPLIED, OF MERCHANTABILITY, OR FITNESS FOR A PARTICULAR PURPOSE OR OTHERWISE, WHICH EXTEND BEYOND THE DESCRIPTION ON THE FACE HEREOF. IN NO CASE SHALL SELLER BE LIABLE TO ANYONE FOR ANY CONSEQUENTIAL OR INCIDENTAL DAMAGES FOR BREACH OF THIS OR ANY OTHER WARRANTY, EXPRESS OR IMPLIED, OR UPON ANY OTHER BASIS OF LIABILITY WHATSOEVER, EVEN IF THE LOSS OR DAMAGE IS CAUSED BY THE SELLER'S OWN NEGLIGENCE OR FAULT.

Seller does not represent that its product may not be compromised or circumvented; that the product will prevent any personal injury or property loss by burglary, robbery, fire or otherwise; or that the product will in all cases provide adequate warning or protection. Buyer understands that a properly installed and maintained alarm may only reduce the risk of a burglary, robbery or fire without warning, but it is not insurance or a guarantee that such will not occur or that there will be no personal injury or property loss as a result. CONSEQUENTLY, SELLER SHALL HAVE NO LIABILITY FOR ANY PERSONAL INJURY, PROPERTY DAMAGE OR OTHER LOSS BASED ON A CLAIM THE PRODUCT FAILED TO GIVE WARNING. However, if Seller is held liable, whether directly or indirectly, for any loss or damage arising under this Limited Warranty or otherwise, regardless of cause or origin, Seller's maximum liability shall not in any case exceed the purchase price of the product, which shall be the complete and exclusive remedy against Seller. This warranty replaces any previous warranties and is the only warranty made by Seller on this product. No increase or alteration, written or verbal, of this Limited Warranty is authorized.



**ALARM DEVICE MANUFACTURING CO.**  
A DIVISION OF PITTWAY CORPORATION  
165 Eileen Way, Syosset, New York 11791