

INSTALLATION INSTRUCTIONS

ALERT III

5700 WIRELESS ALARM SYSTEM

***DO NOT OPEN THIS MANUAL UNTIL YOU HAVE READ
THE NOTICE BELOW***

ALERT III NOTICE

This manual covers a system which is only compatible with RF transmitters from the ALERT III product line. The No. 5720 Receiver/Control is not compatible with 5600 series ALERT II RF transmitters (transmitters that are to be used in ALERT III systems are listed on page 3 of this manual).

Users of ALERT II transmitters should be cautioned that transmitter DIP switch code settings in the ALERT III are the reverse of those in the ALERT II. Before coding any transmitter to be used in the ALERT III system, carefully check the DIP switch settings shown in Diagram 6 of this manual and in the instructions (when provided) that accompany the transmitter.

Also, before assigning ID numbers to the transmitters, be sure to refer to Table A which indicates permissible ID numbers that may be assigned to each transmitter, depending on transmitter model and zone usage.

MARGIN LINES INDICATE PRINCIPAL CHANGES IN THIS ISSUE

TABLE OF CONTENTS

| Section | Subject | Page |
|---------|---|------|
| I. | 5700 SYSTEM OVERVIEW..... | 3 |
| | General Information..... | 3 |
| | System Features..... | 3 |
| II. | DESCRIPTION OF 5700 SYSTEM COMPONENTS..... | 5 |
| | No. 5720 Receiver/Control..... | 5 |
| | No. 5621 Security Console..... | 5 |
| | No. 5727 Portable Remote Wireless Keypad/Transmitter..... | 8 |
| | No. 5330 Alpha Console..... | 9 |
| | Transmitter/sensors..... | 10 |
| III. | PROGRAMMING THE TRANSMITTERS..... | 12 |
| | General Information..... | 12 |
| | Transmitter Programming..... | 12 |
| IV. | PROGRAMMING THE No. 5720 RECEIVER/CONTROL..... | 14 |
| | Preliminary PROM Data..... | 14 |
| V. | PRELIMINARY INSTALLATION PROCEDURE..... | 19 |
| | Preliminary Programming/Location Test..... | 19 |
| VI. | INSTALLING THE No. 5720 AND THE SECURITY CONSOLE..... | 22 |
| | Installation and Wiring of No. 5720 Receiver/Control..... | 22 |
| | Installation and Wiring of No. 5621 Security Console..... | 26 |
| VII. | INSTALLING THE TRANSMITTERS..... | 27 |
| VIII. | SYSTEM FINAL TEST AND CHECKOUT..... | 29 |
| IX. | TURNING THE SYSTEM OVER TO USER..... | 31 |
| X. | TROUBLESHOOTING..... | 32 |
| XI. | GENERAL SPECIFICATIONS..... | 35 |
| | LIMITATIONS OF THIS ALARM SYSTEM..... | 38 |
| | LIMITED WARRANTY..... | 39 |

Diagrams and Tables

| | | |
|-------------|---|----|
| Diagram 1. | No. 5720 Receiver/Control..... | 6 |
| Diagram 2. | No. 5621 Security Console..... | 7 |
| Diagram 3. | No. 5727 Portable Remote Wireless Keypad/Transmitter..... | 9 |
| Diagram 4. | No. 5330 Alpha Security Console..... | 9 |
| Diagram 5. | Transmitters/Sensors..... | 11 |
| Diagram 6. | ID Switch Settings for Nos. 5701, 5727..... | 13 |
| Diagram 7. | Summary of Connections..... | 25 |
| Diagram 8. | Siren Speaker Configurations..... | 26 |
| Diagram 9. | No. 5711/5711WM Installation Details..... | 28 |
| Diagram 10. | No. 5711WM Mounting Details..... | 28 |
| Table A. | Transmitter ID Number Assignment..... | 12 |
| Table B. | Preliminary PROM Programming Data Form..... | 17 |

I. 5700 SYSTEM OVERVIEW

GENERAL INFORMATION

The 5700 Wireless Alarm System is a supervised, 64-point, residential security system that provides burglary, fire and panic (police/emergency) protection. The System consists basically of a Receiver/Control, one or more operating Consoles, and various battery-operated* sensor/transmitters for burglary and fire detection. Alarm, status and control information is transmitted via Ultra High Frequency (UHF) radio transmission at 345 MHz (U.S. only) to the receiver/control unit consisting of an RF receiver and a microprocessor based control which recognizes alarms, status messages and control signals and produces the required response.

* With use of available Lithium batteries, transmitters can be operated for up to 5 years before battery replacement becomes necessary (5-year battery service not yet approved in a UL installation).

An installation may include the following:

| Model | Description | Quantity | |
|------------|--|-----------------------|-------------------------------------|
| No. 5720 | Receiver/Control | 1 | |
| No. 5621 | Numeric Security Console (wired) | 1 (plus up to 2 more) | |
| No. 5330 | Alpha Numeric Security Console (Wired) | 1 (plus up to 3 more) | |
| No. 5727 | Remote Wireless Keypad/Transmitter | (Optional, no max.) | |
| No. 5701 | Emergency (Panic) Transmitter | As required (no max.) | |
| No. 5706 | Smoke Detector Transmitters | 8 max. | System max. is 63, any combination. |
| No. 5711 | Door/Window Transmitters (Slimline) | 63 max. | |
| No. 5711WM | Door/Window Transmitters (Slimline, with built-in reed switch & magnet) | 63 max | |
| No. 5715 | Universal Transmitter, N.O. or N.C. circuit, selectable loop response, tamper option | 63 max | |
| No. 5775 | Passive Infrared Detector Transmitter | 16 max. | |

Note: Above does not include contacts, foil etc. that may be used with Nos. 5711, 5711WM or 5715.

In addition, optionally, a digital communicator (e.g., No. 678, 693**, 693EN**, 694EN**), long range radio transmitter (e.g., No. 7620AD**), or Derived Channel Subscriber Terminal Unit (e.g. No. 698**) may be used for remote notification of trouble and alarm conditions. An X10 Burglary Alarm Interface (BA284)** may be added to utilize the "lights-on" voltage output described herein

** These devices not UL Listed for household fire/burglary use with this system.

SYSTEM FEATURES

- Wireless Operation:** Burglary, fire and emergency status (contact open, contact closed, supervision check, low battery) is sent to the No. 5720 Receiver/Control via battery powered radio transmitters.
- House Identification:** The No. 5720 recognizes 1 of 32 available house identification numbers. Only transmitters set for and sending the number set in the No. 5720 are processed. This prevents transmitters in different residences from activating this receiver/control.
- Transmitter Identification:** Each burglary and fire transmitter sends a unique ID number to the No. 5720 Receiver/Control, which is displayed on the wired Security Console in case of supervision check, low battery, alarm or open contact. The No. 5720 can identify up to 64 different transmitters including emergency (panic) zones (for low battery and alarm), and a problem on its one wired zone.

4. **Supervised Burglary and Fire Zones:** The No. 5720 expects a regular, automatic check-in message from each burglary and fire transmitter. If no messages are received from a particular transmitter during an installer-programmed check-in Interval (24 hours is required for UL Listed household fire/burglary use), the wired Security Console annunciates a loss of check-in signal message.
5. **Separate Entry/Exit, Interior/follower, and Perimeter burglary zones.**
6. **Delayed burglary protection for entry/exit zone:** Entry time can be independent of exit time. INSTANT function allows entry delay to be eliminated for greater security when the user is in residence or away for an extended period.
7. **Low Battery Monitoring:** All transmitters automatically test their batteries and transmit a low battery condition when it occurs. At that time, the battery will have approximately 30 days of life remaining, depending on usage.
8. **Fail-Safe Arming:** Burglary protection may not be turned on if any burglary transmitter is reporting an open condition (which can be identified on the Security Console's display). If the fault cannot be cleared, the faulted transmitter(s) in that zone may be bypassed at the Security Console.
9. **Master (Permanent) Access Code:** All keypad functions except Ready can be activated only after entering a 4-digit access code, which is securely stored in the No. 5720 Receiver/Control.
10. **Temporary Access Code:** This can be changed from any keypad as often as desired for visitors, babysitters, etc.
11. **Ambush digit:** When entered in place of the last access code digit, a silent police alarm message will be sent to a central station (optional) while the requested keypad function is normally executed (e.g., disarming).
12. **Installation Options in PROM:** Master access code, ambush digit, entry time, exit time, burglary siren/bell delay and cutoff times, house ID, AC loss warning delay, wired zone programming, "lights on" option selections, burglary transmitter zone assignments and supervision check period are PROM programmed.
13. **Communicator (Dialer) triggers** are provided for the fire, burglary (with a special "by zone" option) and panic alarms, for loss of check-in signal, low battery, and receiver/control AC power loss.
14. **Built-In Siren Driver** with different sounds for burglary/audible emergency (rapid or slow hi-lo siren sound), and for fire/auxiliary (interrupted rapid hi-lo siren sound).
15. **Timer Speed-Up** feature for installation test purposes.
16. **One Wired Zone** on No. 5720 for convenient protection of opening(s) nearby that may not warrant a radio transmitter or for interface of non-wireless sensors (e.g., Inertia Crossbar System for perimeter protection).
17. **Keypad Timeout:** If more than 2 seconds elapse between successive key depressions, all prior information will be erased, thus requiring the entry sequence to be started again.
18. **AC Loss Trouble Indication** provided when AC power is off for more than a PROM programmed interval.
19. **Built-In Field Strength Indicator (FSI):** Whenever the No. 5720 is placed in the TEST mode, the signals from any transmitter are received with reduced sensitivity. A system where all transmitters can communicate in the Test mode is one that can be assured of reliable operation in normal usage.
20. **Optional "Lights-On" control of premises lighting during alarm and/or during entry into the premises** via AC line carrier transmission from an X10 (BA284) transmitter module* located at the Receiver/Control to any of X10's lighting control modules (plug-in, wall outlet or wall switch type).

* This device not UL Listed for household fire/burglary use with this system.

II. DESCRIPTION OF 5700 SYSTEM COMPONENTS

No. 5720 RECEIVER/CONTROL (See Diagram 1)

The No. 5720 monitors all transmitters, wired sensors, keypads, and consoles and generates appropriate output signals. It provides three supervised zones of burglary protection (entry/exit, perimeter and interior/follower), a supervised 24-hour fire zone, a 24-hour auxiliary alarm zone and two 24-hour panic zones (police and emergency). A built-in siren driver is provided for connection of external alarm siren speaker(s). Alternatively, an alarm bell can be connected to the unit's alarm relay contacts.

There are no switches inside the No. 5720's cabinet for use during normal operation; however, 3 posts (located on the left side of the unit's large printed circuit board) are provided for test and installation aid purposes. If the upper post is shorted to the middle one (SUPERVISION TEST posts), all of the unit's timing intervals are divided by a factor of 60 (exclusive of AC power loss timing, which becomes instant). That is, all of the "hour" intervals become "minute" and all of the "minute" intervals become "second". If the lower post is shorted to the middle one (RESET posts), the system's microprocessor is reset.

The No. 5720 also contains three system fuses and a connector for an optional digital communicator such as the No. 678*. The PROM that contains the system configuration is installed in a plug-in socket on the No. 5720's printed circuit board.

*For optimum protection against electrostatic transients (e.g., lightning, static discharge), the communicator should be mounted in the same cabinet as the receiver/control.

No. 5621 SECURITY CONSOLE (See Diagram 2)

The No. 5621 provides all system status indications and permits all system control functions. Its keypad is used to turn the burglary protection on and off. This protection may be turned on (armed) with or without entry delay and/or interior zone protection. The CHIME mode, when turned on, provides audible and visual perimeter annunciation in the disarmed state. Problem sensors that are preventing burglary system arming may be bypassed. A temporary access code may be assigned and a user TEST mode may be activated. In addition, fire, police, emergency and auxiliary** alarms may be manually activated at the No. 5621. A built-in speaker provides audible alarms, warnings for check-in signal loss, AC power loss and low battery, plus annunciation functions. The system monitors the transmitters at all times and displays appropriate messages on the No. 5621 by means of three message indicators: BURGLARY (lights when a transmitter/sensor is triggered), CHECK (lights when there is a loss of periodic check-in signals from any transmitter), and LOW BAT (lights when the battery in any alarm transmitter is low). A 2-digit numeric display gives transmitter identifications.

Up to 2 additional wired No. 5621 Security Consoles (or 3 additional No. 5330s) may optionally be connected in parallel with the first with a separate wiring run from the receiver/control to each console. Do not "daisy chain wire" consoles on one four-wire run.

** AUXILIARY will activate an alarm or a "lights on" output, as programmed. No AUXILIARY alarm capability is permitted in a UL Listed household fire/burglary installation.

LEDs and Message Displays on the No. 5621:

1. **FIRE, POLICE, EMERGENCY and AUXILIARY Indicators (Red):** Light when the corresponding alarms are triggered. If the Silent Police Alarm has been selected (see "Preliminary PROM Data", item 19), the POLICE indicator on the No. 5621 is never illuminated. These indicators (and external sounder) are turned off by entering the access code followed by OFF. A "Silent Police Alarm" at the No. 5720 Receiver/Control is automatically reset after a few seconds.
2. **OFF Indicator (Green):** Lit while the burglary protection is off.
3. **AWAY and HOME Indicators (Red):** Never both lit at the same time. The AWAY indicator is lit while the burglary protection, including the Interior Zone, is on. The HOME indicator is lit while the burglary protection, *not* including the Interior Zone, is on. Either indicator is turned off by entering the access code followed by OFF.
4. **POWER Indicator (Green):** Lit when AC power is on and out when AC power is off. If AC power remains off for more than PROM programmed period, this indicator will remain out even if AC power is restored. This indicator can then be re-lit only by keying the access code plus OFF.
5. **TEST Indicator (Amber):** Lit while the TEST feature is turned on. TEST may be turned on only when burglary protection is off. A single beep will occur once every 30 seconds as a reminder that the system is in the TEST mode.

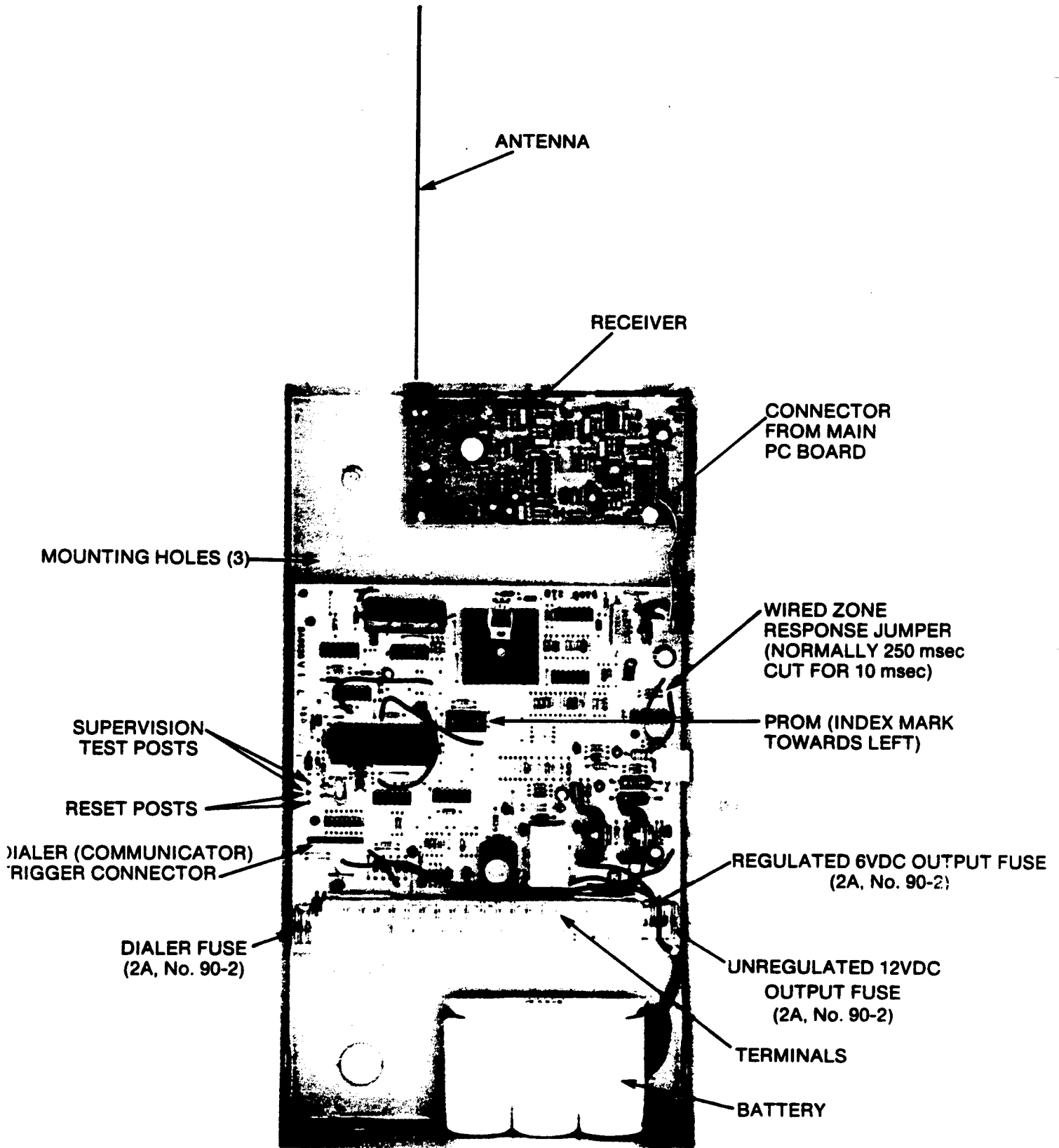
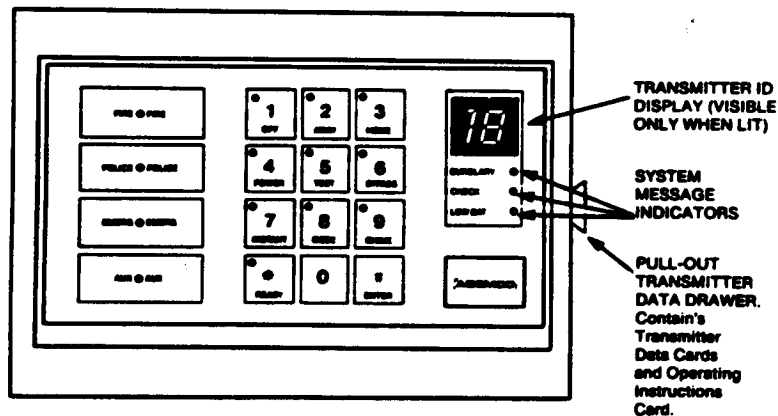

Diagram 1. No. 5720 RECEIVER/CONTROL (Less Cabinet Cover)

6. **BYPASS Indicator (Amber):** Lit only while burglary protection is on with one or more faulted transmitters bypassed. Always turns off when the burglary protection is turned off.
7. **INSTANT Indicator (Amber):** Lit while the burglary protection is on with no entry delay. May be turned on with the burglary protection. Always turns off when burglary protection is turned off.
8. **CODE Indicator (Amber):** If lit, signifies that the secondary code can be used to arm or disarm the system. If the system was armed using the primary code, the Code Indicator is extinguished, indicating that only the primary code can be used to disarm the system.
9. **CHIME Indicator (Amber):** Lit while the CHIME feature is turned on. CHIME feature may be turned on only when burglary protection is off. While the system is disarmed, the No. 5621 beeps once whenever any entry/exit or perimeter sensor/transmitter is disturbed.
10. **READY Indicator (Green):** Lit when all burglary sensors/transmitters have reported closed loop status (no faults). May be lit only while burglary protection is off.
11. **TRANSMITTER IDENTIFICATION Display:** Two-digit numeric display located on the right-hand side of the No. 5621. When more than one number must be displayed, they are shown sequentially, repetitively. Each number is displayed for approximately 2 seconds. Located just below this window are 3 message indicators which light to indicate the reason for the display (see items 12, 13, 14, that follow). When the burglary protection is off, transmitter numbers identifying open sensors may be displayed. In this case, no message indicator will be lit.
12. **BURGLARY Indicator (RED):** Lit when a burglary alarm has been triggered. TRANSMITTER IDENTIFICATION display indicates which transmitter(s) caused the alarm. A "00" indication denotes a wired loop disturbance. Extinguished (and external sounder silenced) by turning off burglary protection (enter access code followed by OFF) and then again entering access code followed by OFF to clear memory (and silence rapidly beeping No. 5621).
13. **CHECK Indicator (RED):** When lit, indicates a loss of Check-in signal. The TRANSMITTER IDENTIFICATION display will indicate which transmitter failed to report. CHECK and LOW BAT may both be lit, indicating that the transmitter battery is too weak for reliable transmission. To check the condition of the identified transmitter, force a transmission by opening and closing the transmitter's loop (or otherwise activating the transmitter), and enter the access code followed by OFF. If the CHECK indicator turns off, the transmitter is functional and the cause of the message has disappeared. If the same transmitter keeps reporting CHECK messages, it may become necessary to relocate the transmitter to improve its transmission path or to replace the transmitter if it is at fault.
14. **LOW BAT Indicator (RED):** If lit, indicates a weak transmitter battery. The TRANSMITTER IDENTIFICATION display indicates which transmitter(s) need new batteries (or that at least one panic transmitter needs a new battery, if more than one panic transmitter is used with the system).



| LED INDICATORS | | |
|----------------|-----------------|----------------------|
| OFF - GREEN | BYPASS - AMBER | FIRE-FIRE - RED |
| AWAY - RED | INSTANT - AMBER | POLICE-POLICE - RED* |
| HOME - RED | CODE - AMBER | EMERG-EMERG - RED |
| POWER - GREEN | CHIME - AMBER | AUX-AUX - RED |
| TEST - AMBER | READY - AMBER | |

*DOES NOT LIGHT IF SILENT POLICE ALARM PROGRAMMED

Diagram 2. No. 5621 SECURITY CONSOLE

AUDIBLE SIGNALS EMITTED BY THE NO. 5621 SECURITY CONSOLE:

| Type of Sound (from No. 5621) | Cause |
|---|---|
| 1. Interrupted, rapidly alternating 2-tone sound. (FIRE or AUX indicator lit) | Fire Alarm or Auxiliary* Alarm. |
| 2. Continuous, slowly alternating 2-tone sound. (BURGLARY, POLICE** or EMERG indicator lit) | Burglary, audible Police or Emergency Alarm. |
| 3. One short beep. | a) System was turned off or failure to arm. b) Sensor in Delay or Perimeter zone activated while system is disarmed and in CHIME mode. |
| 4. One short beep, repeated every 30 seconds. | Reminder that system is in TEST mode. |
| 5. Two short beeps. | a) System armed AWAY. b) System just put in TEST mode. c) Sensor activated or deactivated while in TEST mode. |
| 6. Three short beeps. | System armed HOME. |
| 7. Rapidly pulsing beeps*** (warning tones) | a) Failure to receive regular check-in message from one or more sensors. b) Low battery detection in one or more sensors. c) Loss of AC power beyond the programmed time period. d) Memory of an alarm (commences during entry). |
| 8. Slowly pulsing beeps | Occurs when entering Entry/Exit Zone with system armed AWAY (no memory of alarm present). Beeps continue throughout Entry delay period until system is turned off. |
| 9. Short "buzz" tone. | Confirmation tone for each key depressed on the keypad. |

* No audible auxiliary alarm if "Lights On" is programmed. *No auxiliary alarm permitted in a UL Listed installation.*

** If configured for Silent POLICE alarm, no audible sound heard and indicator does not light.

*** For a non-UL Listed Household Burglary application, audible annunciation may be optionally omitted (not applicable to "memory of alarm", which always has audible annunciation).

No. 5727 REMOTE WIRELESS KEYPAD/TRANSMITTER (OPTIONAL)

The No. 5727 is a portable keypad which can be used to turn the burglary protection on and off and perform certain other system functions remotely, without interconnecting wires. No audible or visual system status indications are provided by the No. 5727 (except for a Red LED indicator on the LIGHTS key which lights when any key is depressed. Silent or audible Police Panic alarms (as programmed by the installer) and "Lights On" (if provision has been made for it) can be initiated at the keypad. Also available is the CHIME feature, and the ability to assign a temporary access code. However, the BYPASS and TEST functions cannot be initiated at the keypad, nor can fire alarms.

Burglary protection can be turned on (armed) and off (disarmed) from the keypad only if there are no faulted burglary transmitters. Since there is no READY indicator light on the keypad to signify that all burglary sensor/transmitters are in a "no-fault" condition prior to arming, and also since there is no HOME or AWAY indicator light, reliance must be placed on audible confirmation from the No. 5621 Security Console (following the arming procedure) as an indication that arming was successful.

Note: A low battery condition in a Remote Wireless Keypad will be signified by a display on the Console of "00" and "LOW BAT".

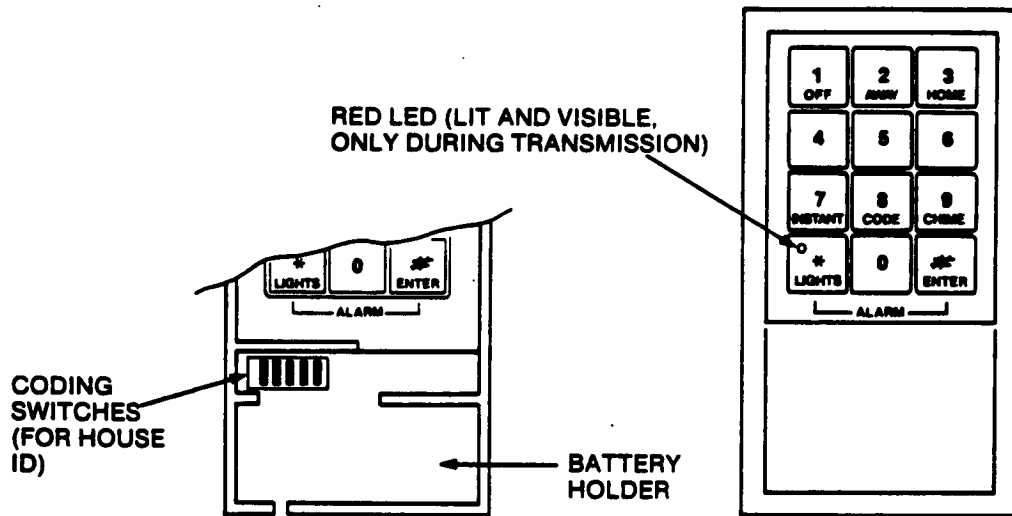

Diagram 3. No. 5727 PORTABLE REMOTE WIRELESS KEYPAD/TRANSMITTER

No. 5330 ALPHA CONSOLE (OPTIONAL)

The No. 5330 is a universal security console which can be easily programmed to interface with the No. 5720 Receiver/Control Unit. It displays two 16-character lines of alphanumeric information in addition to emitting audible beeps consistent with those of the No. 5621 console. The No. 5330 is programmable from its own keypad to display transmitter alphanumeric descriptors underneath alphanumeric information relating to the status of the given transmitter. System status, check, low battery, etc., as well as alarm information is also displayed on the No. 5330. Any combination of three No. 5330 and/or No. 5621 security consoles can be supported by the No. 5720 (or up to four No. 5330s). Refer to the No. 5330's Installation and User manuals for further information.

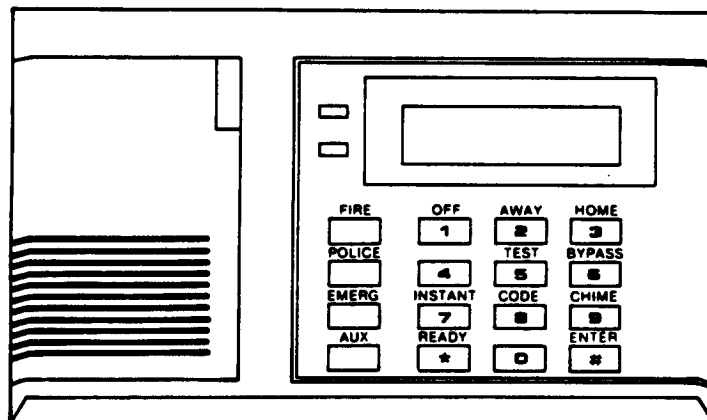

Diagram 4. No. 5330 ALPHA CONSOLE

TRANSMITTER/SENSORS (See Diagram 5)

- 1. No. 5711WM Door/Window Transmitter (Slimline Design) (Diagram 5a):** Provides door (or window) protection with no wiring required. Transmitter unit containing reed switch mounts on door (or window) frame and its accompanying magnet mounts on door or window.

This transmitter also has a closed protective loop connected in parallel with the magnetic reed switch. If the magnet is used, the protective loop terminals should not be used (no wires connected to them). If the wired protective loop is used, the magnet should not be used (discarded). It may be assigned any of the 63 transmitter ID numbers and therefore can be used to generate fire, auxiliary, and panic transmissions as well as a burglary transmission.

- 2. No. 5711 Door/Window Transmitter (Slimline Design) (Diagram 5a):** Particularly convenient for mounting on narrow window frames [unit is less than 1-3/8" (35 mm) wide]. Provides protection via an open or closed protective loop which may contain reed type magnetic contacts or foil. It may be assigned any of the 63 transmitter ID numbers as with the No. 5711WM.
- 3. No. 5775 Passive Infrared Detector/Transmitter (Diagram 5b):** Provides 9 zones of wide angle (84 degree span) coverage with a pattern range of up to 35 (10 M) feet. Wall/corner mounting provided. Has LED walk test capability. Complete descriptive and installation information accompanies the No. 5775. Successive transmissions are limited by a 3 minute transmit inhibit delay to preserve battery life.
- 4. No. 5706 Smoke Detector/Transmitter (Diagram 5c):** A smoke detector and RF transmitting circuit boards are integrated into a single wall or ceiling mountable unit. Powered by a single 9-volt battery located in an easily accessible compartment on the base of the unit. Smoke detection is by photoelectric obscuration. Unique transmission pattern is repeated every 12 seconds as long as the smoke detector remains faulted.
- 5. No. 5715 Universal Transmitter (Diagram 5d):** Designed to provide protection via a closed or open circuit loop, this transmitter features open circuit burglary/fire capability for use with mats or thermostats, or closed circuit capability for use with contacts, glass break sensors, etc. (not to be used with battery operated smoke detectors). Can be configured for any of three transmission formats -- Burglary, Fire or Auxiliary. Includes tampered cover for burglary use. Can be programmed for either fast or slow response. Can be recess mounted using a No. 5604 mounting kit.
- 6. No. 5701 Emergency (Panic) Transmitter (Diagram 5e):** This transmitter may be carried about the protected area in a pocket or purse (a No. 5634 Belt Clip is optional). A keyslot hole permits mounting in any convenient location, if desired.

The button on this transmitter must be depressed a minimum of 1 second to trigger an alarm. This alarm transmission will repeat every 2 seconds as long as the button is depressed. The LED will light each time a transmission occurs. The LED may not light if the battery is weak (indicated by a LOW BAT message on the security console), but the unit may still transmit.

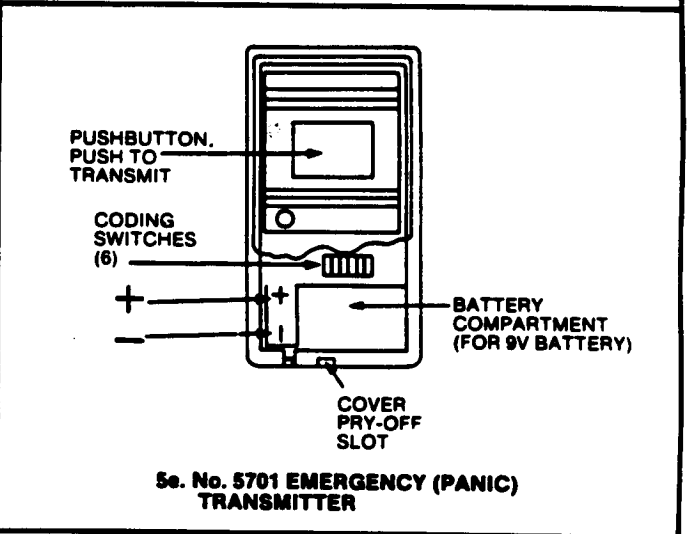
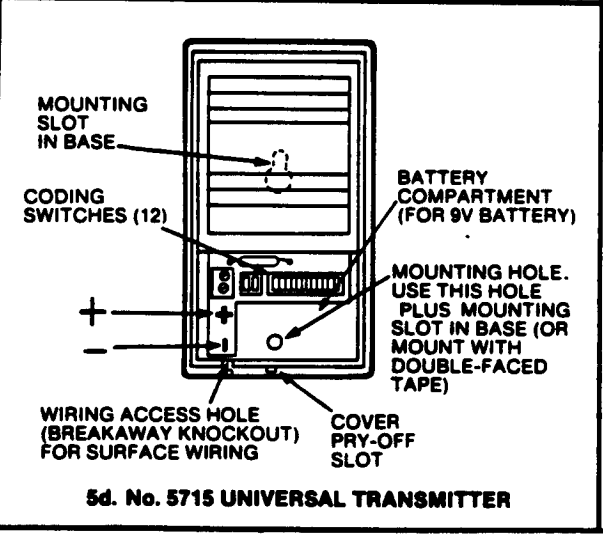
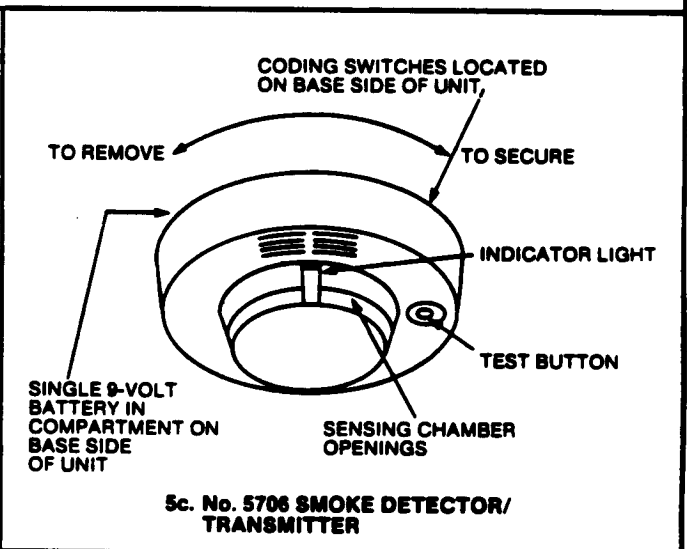
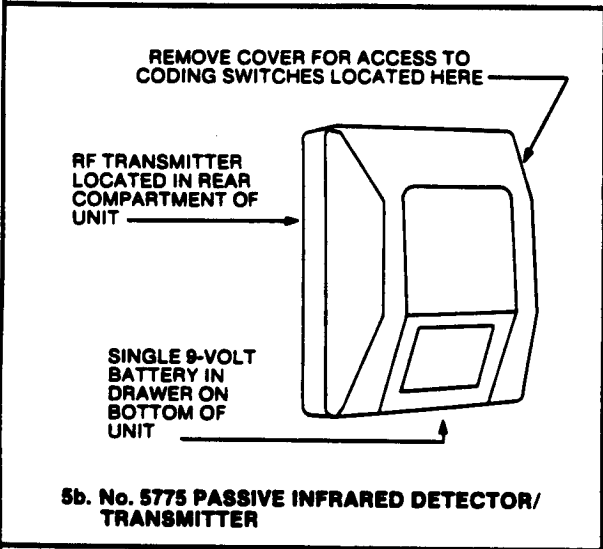
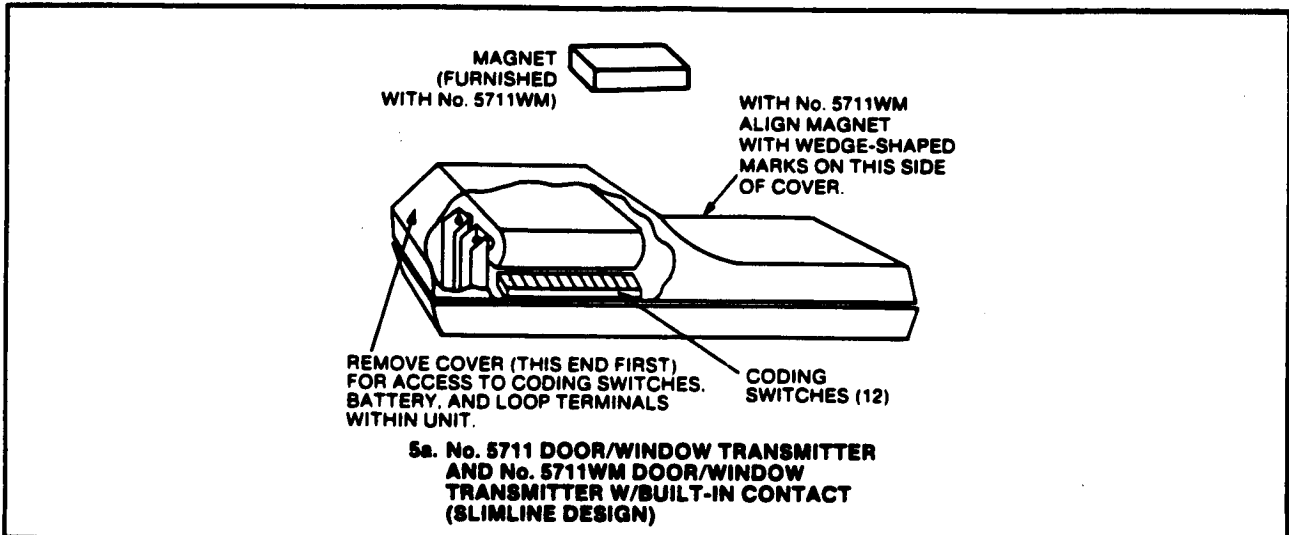

Diagram 5. SENSOR/TRANSMITTERS

III. PROGRAMMING THE TRANSMITTERS

GENERAL INFORMATION

The number of transmitters needed in the system must be determined by surveying the premises. "Preliminary Installation Procedure" in Section V should be consulted for guidance in selecting locations for the transmitters.

All transmitters in the system must be programmed with the same House ID, but each transmitter is assigned a unique transmitter ID. Table A in this section provides information on the manner in which the various transmitter IDs are apportioned.

Diagram 6 provides programming information for Nos. 5701, and 5727 transmitters. Programming information for Nos. 5706, 5711/5711WM, 5715, and 5775 is contained in the instructions that accompany those units.

After each transmitter's coding switches have been set, mark each transmitter (with a tag or piece of masking tape) to indicate its transmitter ID number and location.

TRANSMITTER PROGRAMMING

CAUTION: Transmitter DIP switch code settings are reversed in ALERT III from those in the ALERT II. Carefully check DIP switch settings in Diagram 6 and in any instructions that accompany the transmitter.

The DIP Switches located on each transmitter must be set for the proper "House ID" and "Transmitter ID" as will later be assigned in the No. 5720's PROM.

1. For EACH transmitter (including the No. 5727 Remote Keypad transmitter), the first 5 switches (1, 2, 3, 4, 5) are used to set the "House ID". (No. 5727 has only 5 switches.)
2. For BURGLARY Transmitters (e.g., Nos. 5711, 5711WM, 5715, 5775), the next switch positions are used to set the "Transmitter ID", as follows: For 5711/5711WM/5715: Positions 6, 7, 8, 9, 10, 11
For 5775: Positions 6, 7, 8, 9
3. For FIRE (e.g., No. 5706) Transmitters, switch positions 6, 7 and 8 used to select "Transmitter IDs".
4. For the No. 5701 Emergency (Single Button Panic) Transmitter, switch position 6 determines whether the unit is set for EMERGENCY Panic ("OFF", ID 63, always audible) or POLICE Panic ("ON", ID 62, either silent or audible, as PROM programmed).
5. For AUXILIARY transmitters (i.e., 5711, 5711WM, 5715), no PROM programming is needed. Just set DIP switches for IDs 59-61.

TABLE A. TRANSMITTER ID NUMBER ASSIGNMENT

| QTY | TRANS-MITTER ID | APPLICABLE TRANSMITTERS | | | | | | APPLICABLE ZONE | COMMENTS |
|-----|-----------------|-------------------------|------|--------------|------|------|-------|---------------------------------|---|
| | | 5701 | 5706 | 5711, 5711WM | 5715 | 5775 | 5727* | | |
| - | 0 | | | | | | | Wired Zone | (one) |
| 31 | 1-31 | | | x | x | | | Entry/Exit, Interior, Perimeter | **Inhibits next fault transmission for 3 minutes after restore. |
| 16 | 32-47** | | | x | x† | x | | | |
| 8 | 48-55 | | x | x | x | | | Fire | Aux transmitters have no supervision. |
| 3 | 56-58 | | | x | x | | | Fire | |
| 3 | 59-61 | | | x | x | | | Aux. | |
| 1 | 62 | x | | x | x | | | Panic | |
| 1 | 63 | x | | x | x | | | Emerg. | Any number of No. 5701s permitted. |

* No transmitter ID assigned in the case of wireless keypads.

† Do not assign an ID number in the 32-47 range to the No. 5715 transmitter if it is to be used in a N.O. circuit application. This will result in a 3-minute delay in the transmitter's restore signal.

| HOUSE I.D. # | SWITCH POSITIONS | | | | |
|--------------|------------------|-----|-----|-----|-----|
| | 1 | 2 | 3 | 4 | 5 |
| 1 | ON | ON | ON | ON | OFF |
| 2 | ON | ON | ON | OFF | ON |
| 3 | ON | ON | ON | OFF | OFF |
| 4 | ON | ON | OFF | ON | ON |
| 5 | ON | ON | OFF | ON | OFF |
| 6 | ON | ON | OFF | OFF | ON |
| 7 | ON | ON | OFF | OFF | OFF |
| 8 | ON | OFF | ON | ON | ON |
| 9 | ON | OFF | ON | ON | OFF |
| 10 | ON | OFF | ON | OFF | ON |
| 11 | ON | OFF | ON | OFF | OFF |
| 12 | ON | OFF | OFF | ON | ON |
| 13 | ON | OFF | OFF | ON | OFF |
| 14 | ON | OFF | OFF | OFF | ON |
| 15 | ON | OFF | OFF | OFF | OFF |
| 16 | OFF | ON | ON | ON | ON |
| 17 | OFF | ON | ON | ON | OFF |
| 18 | OFF | ON | ON | OFF | ON |
| 19 | OFF | ON | ON | OFF | OFF |
| 20 | OFF | ON | OFF | ON | ON |
| 21 | OFF | ON | OFF | ON | OFF |
| 22 | OFF | ON | OFF | OFF | ON |
| 23 | OFF | ON | OFF | OFF | OFF |
| 24 | OFF | OFF | ON | ON | ON |
| 25 | OFF | OFF | ON | ON | OFF |
| 26 | OFF | OFF | ON | ON | ON |
| 27 | OFF | OFF | ON | OFF | OFF |
| 28 | OFF | OFF | OFF | ON | ON |
| 29 | OFF | OFF | OFF | ON | OFF |
| 30 | OFF | OFF | OFF | OFF | ON |
| 31 | OFF | OFF | OFF | OFF | OFF |

| TRANS. | SWITCH | ZONE |
|--------|--------|--------|
| 62 | ON | PANIC |
| 63 | OFF | EMERG. |

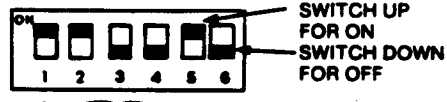

HOUSE I.D. TRANS I.D.

SHOWN SET FOR HOUSE I.D.: 6
TRANSMITTER I.D.: 63

No. 5701 EMERGENCY (PANIC) TRANSMITTER

| HOUSE I.D. # | SWITCH POSITIONS | | | | |
|--------------|------------------|-----|-----|-----|-----|
| | 1 | 2 | 3 | 4 | 5 |
| 1 | ON | ON | ON | ON | OFF |
| 2 | ON | ON | ON | OFF | ON |
| 3 | ON | ON | ON | OFF | OFF |
| 4 | ON | ON | OFF | ON | ON |
| 5 | ON | ON | OFF | ON | OFF |
| 6 | ON | ON | OFF | OFF | ON |
| 7 | ON | ON | OFF | OFF | OFF |
| 8 | ON | OFF | ON | ON | ON |
| 9 | ON | OFF | ON | ON | OFF |
| 10 | ON | OFF | ON | OFF | ON |
| 11 | ON | OFF | ON | OFF | OFF |
| 12 | ON | OFF | OFF | ON | ON |
| 13 | ON | OFF | OFF | ON | OFF |
| 14 | ON | OFF | OFF | OFF | ON |
| 15 | ON | OFF | OFF | OFF | OFF |
| 16 | OFF | ON | ON | ON | ON |
| 17 | OFF | ON | ON | ON | OFF |
| 18 | OFF | ON | ON | OFF | ON |
| 19 | OFF | ON | ON | OFF | OFF |
| 20 | OFF | ON | OFF | ON | ON |
| 21 | OFF | ON | OFF | ON | OFF |
| 22 | OFF | ON | OFF | OFF | ON |
| 23 | OFF | ON | OFF | OFF | OFF |
| 24 | OFF | OFF | ON | ON | ON |
| 25 | OFF | OFF | ON | ON | OFF |
| 26 | OFF | OFF | ON | OFF | ON |
| 27 | OFF | OFF | ON | OFF | OFF |
| 28 | OFF | OFF | OFF | ON | ON |
| 29 | OFF | OFF | OFF | ON | OFF |
| 30 | OFF | OFF | OFF | OFF | ON |
| 31 | OFF | OFF | OFF | OFF | OFF |

CAUTION: Transmitter DIP switch code settings are reversed in ALERT III from what they are in the ALERT II. Carefully check the DIP switch settings shown on this page.

NOTE: ID SWITCH SETTINGS FOR Nos. 5711/5711WM 5715, 5775 AND 5706 ARE PROVIDED IN THE INSTRUCTIONS ACCOMPANYING THOSE UNITS.



HOUSE I.D.

SHOWN SET FOR HOUSE I.D.: 2

No. 5727 PORTABLE REMOTE WIRELESS KEYPAD/TRANSMITTER

Diagram 6. ID SWITCH SETTINGS FOR Nos. 5701, 5727

IV. PROGRAMMING THE No. 5720 RECEIVER/CONTROL

PRELIMINARY PROM DATA

The No. 5720 Receiver/Control uses a plug-in No. 691 PROM (not supplied) that must be custom programmed (by or for the installer) for each system. The following preliminary PROM data will be needed for each installation and should be determined, where appropriate, by consulting with the homeowner. Use Table B in this manual to record the data. Complete information for utilizing this data in the programming of the PROM with a No. 699 PROM Programmer accompanies the No. 699. For those using the No. 690 PROM Programmer, refer to the Prom Programming Form for No. 5720 (part number N4631) which has been supplied.

1. **AC POWER LOSS AUDIBLE/TRIGGER WARNING DELAY:** Any multiple of 4 minutes (32 minutes maximum) may be chosen.
 2. **MASTER (PERMANENT) ACCESS CODE:** Any 4 digits (different or repeated) may be selected.
 3. **AMBUSH DIGIT:** Sends silent police alarm via optional communicator, when entered in lieu of last digit of Master Code. Any digit different from last digit of Master Access code may be selected.
 4. **ENTRY DELAY:** Any multiple of 15 seconds (120 seconds max.) may be chosen. Maximum permissible entry delay per UL Std. 1023 for Household Burglary is 45 seconds.
 5. **EXIT DELAY:** Any multiple of 15 seconds (120 seconds max.) may be chosen. Maximum permissible exit delay per UL Std. 1023 is 60 seconds.
 6. **DELAY ON EXTERIOR BURGLARY SIREN/BELL SOUNDING AND DIALER TRIGGER OUTPUT:** Any multiple of 15 seconds (120 seconds max.) may be chosen. *Selection of 0 (no delay) is mandatory for UL Listed household fire/burglary use.*
 7. **SIREN/BELL SOUNDING DURATION:** Any multiple of 4 minutes (32 minutes max.) may be chosen. Minimum sounding duration per UL Std. 1023 for Household Burglary is 4 minutes. Fire sounding per UL Std. 985 shall be present until the system is reset (i.e., no cutoff).
 8. **CHECK-IN MONITORING INTERVAL:** Any multiple of 2 minutes (240 minutes thru 1996 minutes) may be chosen. A value of 1440 minutes or 24 hours is recommended, *but a value of 720 minutes or 12 hours is required for a UL Listed household fire/burglary installation.* If no signals are received from a given transmitter by the No. 5720 during the programmed Check-In Interval, a CHECK message is annunciated for that transmitter by the No. 5621 or No. 5330 Security Console. Check-in monitoring may be optionally eliminated (except in a UL installation).
- Notes:**
- a. The elapsed time from the beginning of a condition that interferes with the reception or transmission of a transmitter's check-in and other signals (e.g., dead or missing transmitter battery, missing transmitter, altered transmission path) and the annunciation of a CHECK message may vary from one to just under two times the programmed Check-In Interval.
For example, consider the recommended Check-In Interval of 1440 minutes (24 hours). If a transmitted signal is received by the No. 5720 from a given transmitter *immediately following* the start of a timed Check-In Interval, but none is received thereafter from that transmitter, it will be just under *48 hours later* (the remainder of that 24-hour interval plus the ensuing 24-hour interval) that a loss of check-in signal CHECK message is annunciated for that transmitter by the Security Console.
On the other hand, suppose that a transmitter's signal is received *immediately preceding* the start of a new timed Check-In Interval, but none is received thereafter from that transmitter during that interval. A loss of check-in signal (CHECK message) will in this case be annunciated for that transmitter by the No. 5621 just *24 hours later*.
 - b. Shorter than 24-hour intervals increase the possibility of unnecessary CHECK messages resulting from temporary extraordinary interferences, while longer intervals delay notification of genuine conditions that should be checked.
9. **LOSS OF AC OR LOSS OF TRANSMITTER CHECK-IN/LOW BATTERY ANNUNCIATION:** Annunciation to the user of the system may be chosen to be both visual and audible at the time that the receiver/control becomes aware of the situation (24-hour annunciation independent of the arming status of the system)* OR only visual (for unnecessary disturbance of the occupants).

* A UL Listed household fire/burglary installation requires selection of both audible and visual annunciation.

10. **AUTOMATIC/MANUAL BYPASS SELECTION:** In the manual mode*, the system is fail-safe armed, wherein an unresolved sensor fault prevents arming of the burglary protection unless the manual BYPASS procedure is used. If automatic bypass is chosen, any unresolved sensor faults will be automatically bypassed when the burglary system is armed in either the HOME or AWAY modes.
* Selection of Manual Bypass is mandatory for UL Listed household fire/burglary use.
11. **EXTERNAL SIREN SOUNDING SELECTION:** Two siren sounding configurations are selectable for burglary, audible police, and emergency alarms. One provides a continuous, *slowly* alternating two-tone siren sound. The other provides a continuous, *rapidly* alternating two-tone siren sound. In *either* case, an interrupted, rapidly alternating two-tone siren sound is produced for fire and audible auxiliary alarms.
12. **AUXILIARY ALARM SOUNDING (& DIALER TRIGGER):** This option is not selectable. The system automatically provides both internal and external sounding (and dialer trigger, if programmed -- see item 17 that follows) for an auxiliary alarm.
Note: No auxiliary alarm is permitted on a UL Listed household fire/burglary installation.
13. **"LIGHTS-ON" OUTPUT DELAY:** A "lights-on" voltage output, capable of energizing an X10 (BA284) Burglary Alarm Interface, can be selected for activation as soon as the console speaker starts producing alarm sounds (instantly for instant zones and after entry delay for delayed zones). Alternatively, it can be selected to be activated as soon as the exterior speaker or bell starts producing alarm sounds. *The X10 (BA284) is not UL Listed for household fire/burglary use with this system.*
14. **AUXILIARY FUNCTION DEFINITION:** The auxiliary function may be selected as a non-alarm function that provides the "all lights-on" voltage output or as a 24-hour auxiliary alarm function.
Note: Non-alarm selection is mandatory for a UL Listed household fire/burglary installation.
15. **"LIGHTS-ON" REACTION TO ENTRY WHEN ARMED "AWAY":** The "lights-on" voltage output can be selected for activation immediately upon faulting the entry/exit zone (opening of a main access door as well as after an alarm) or only subsequent to an audible alarm. *The "Lights-on" function using the X10 (BA284) is not permitted in a UL Listed household fire/burglary installation.*
16. **HOUSE ID:** Any number from 00 thru 31 may be chosen. All of the system's transmitters will later be set for this House ID number and only transmitters sending this number will be recognized and processed by the No. 5720 Receiver/Control. *It is imperative that a House ID that is not being used in a nearby installation be chosen in order to prevent accidental triggerings.*
17. **DIALER TRIGGER CONFIGURATION:** Two configurations of dialer triggers are selectable. One provides a unique trigger for every condition: burglary, fire, police, emergency, and auxiliary alarms, AC power loss, transmitter low battery, and loss of transmitter check-in signal. The second provides burglary triggers by zone -- entry/exit, perimeter, and interior. However, to get this, the auxiliary alarm trigger is eliminated and the transmitter low battery condition and the loss of transmitter check-in signal condition have their reporting combined into one common dialer trigger, produced for either condition.
18. **WIRED LOOP:** The No. 5720 Receiver/Control has provision for a wired, supervised protective zone that must be PROM programmed for one of the following:
"Entry/Exit" (or if wired loop not used*)
"Interior" (burglary)
"Perimeter" (burglary)
"Police" (alarm)
"Emergency" (alarm)
Caution: Do not select the wired zone as an "Interior" zone unless one or more transmitters are also going to be used in the Interior zone. Otherwise, the wired zone will not be bypassed when the burglary protection is turned on while the home is occupied.
* Important: If the wired loop is not used, program for Entry/Exit and connect an end-of-line resistor across terminals 12 and 13. This will ensure that a low battery condition in a Remote Wireless Keypad will produce a "00" and "LOW BAT" display at the Console.
19. **RESPONSE TO POLICE ALARM** (from No. 5701, 5727 or Security Console) may be PROM programmed to be "silent" (no bell, siren, or display) or "audible" upon triggering. One of these two options should be selected.
20. **BURGLARY ALARMS TRIGGERED PER TRANSMITTER DURING AN ARMED PERIOD:** Selection may be made of single or multiple alarm sounding/reporting during one armed period.

21. **TRANSMITTER IDs:** The number of transmitters to be assigned to each of the No. 5720 Receiver/Control's burglar alarm zones must be determined by surveying the premises. "Preliminary Installation Procedure" in Section V (following) should be consulted for guidance in selecting locations for the transmitters. Portable Wireless Keypad/Transmitters (No. 5727) are not assigned ID numbers.

- a. **Burglary Transmitter IDs:** A maximum total of 47 burglary transmitters (e.g. Nos. 5711, 5711WM, 5715, 5775) may be assigned to the Entry/Exit Delay, Interior and Perimeter zones, apportioned in any manner. Moreover, a single transmitter (such as the No. 5711, 5711WM or 5715) may protect more than one opening if several contacts or devices are connected in its protective loop.
- b. **Fire Transmitter IDs:** A maximum total of 8 No. 5706 Smoke Detector Transmitters may presently be assigned to the system. However, an additional 3 Fire Transmitters may be assigned using the No. 5715, 5711 or 5711WM configured as a Fire Transmitter. Use No. 502 (135°F/57°C) or No. 504 (190°F/87°C) N.O. heat detectors with the Nos. 5711, 5711WM or 5715 transmitter. The distance of a heat detector from its associated transmitter should be no more than 3 ft, and must be tested on a regular basis, in accordance with the heat detector's instructions.
- c. **Panic Transmitter IDs:** Any number of No. 5701 Emergency (Panic) Transmitters may be used with the system; however, their Transmitter ID's are predetermined and no PROM programming is necessary.
- d. **Transmitter ID numbers should be assigned, in accordance with the following rules:**
 - 1) **ID Number "00"** is reserved for the wired zone, and as a low battery message display for the Remote Wireless Keypad.
Numbers 01 through 47 are available for burglary transmitters (group them by zone in this order: Entry/Exit, Perimeter, Interior).
Numbers 48 through 55 are reserved for No. 5706 Smoke Detectors or other fire sensor/transmitters.
Numbers 56-58 can also be used for fire via use of the Nos. 5711, 5711WM, or 5715.
Numbers 59-61 are reserved for auxiliary zone transmitters. **Numbers 62 and 63** are used by panic transmitters (62 for police panic, 63 for emergency panic). No PROM programming is necessary for transmitters assigned ID numbers 59 through 63 (these transmitters are therefore unsupervised).
 - 2) **Leave gaps between each zone's transmitter ID numbering sequence** to permit future expansion.
 - 3) **Never have unused ID numbers between the first and last ID numbers of a zone.**
 - 4) **If the zone has only one transmitter, that zone's "first" and "last" ID number in the PROM programming will be the same.**

EXAMPLE: For a system with 6 Entry/Exit zone transmitters, 6 Interior, 16 Perimeter, 5 Fire and 2 Panic transmitters, the following ID numbers could be assigned:

| TRANSMITTER ID | ASSIGNMENT |
|----------------|--|
| 00 | Reserved for Wired Loop (may be programmed for Entry/Exit, Interior, Perimeter, Police or Emergency) |
| 01 - 06 | Entry/Exit. |
| 07, 08 | Future Entry/Exit. |
| 09 - 24 | Perimeter. |
| 25 - 31 | Future Perimeter. |
| 32 - 37 | Interior. |
| 38 - 47 | Future Interior. |
| 48 - 52 | Fire. |
| 53 - 58 | Future Fire. |
| 59 - 61 | Reserved for Auxiliary transmitters. |
| 62 | Police Panic (may be PROM programmed for "silent" or "audible"). |
| 63 | Emergency Panic (always "audible"). |

TABLE B. PRELIMINARY PROM PROGRAMMING DATA
 (USE ONLY WHEN PROGRAMMING WITH No. 690 PROM PROGRAMMER)

AC POWER LOSS WARNING DELAY: 4 min x
 (Select digit 0 thru 8, 9 eliminates warning)

MASTER (PERMANENT) ACCESS CODE:
 (Select any 4 digits)

AMBUSH DIGIT:
 (Select digit different from last digit of Master Access Code)

ENTRY DELAY:..... 15 secs x
 (Select digit from 1 thru 8, 0 for No Delay..."3" max for UL Listed household fire/burglary use)
 9 gives infinite delay - DO NOT USE

EXIT DELAY: 15 secs x
 (Select digit from 1 thru 8, 0 for No Delay..."4" max for UL Listed household fire/burglary use)
 9 gives infinite delay - DO NOT USE

DELAY TO EXTERIOR BURGLARY SIREN/BELL & DIALER TRIGGER: 15 secs x
 (Select digit 1 thru 8, 0* for No Delay) 9 give infinite delay - DO NOT USE

SIREN/BELL SOUNDING DURATION: 4 min x
 (Select digit from 1 thru 8, 9* for no cutoff)

CHECK-IN MONITORING INTERVAL: 2 min x
 (Select 3 digit number from 120 thru 998, 999 eliminates monitoring...720 [24 hour interval] is recom-
 mended. 360 is required for UL Listed household fire/burglary use).

LOSS OF AC/LOSS OF CHECK-IN/LOW BATTERY AUDIBLE ANNUNCIATION: Yes* No
 (Check one)

BYPASS: Automatic at Arming Manually Selectable at Arming*
 (Check one)

EXTERNAL SIREN SOUND (Check one)

Slow 2-Tone for burglary/police (audible)/emergency
 Pulsed Rapid 2-Tone for fire/burglary
 Rapid 2-Tone for burglary/police (audible)/emergency
 Pulsed Rapid 2-Tone for fire/auxiliary

SOUNDER (& DIALER TRIGGER) RESPONSE TO AUXILIARY ALARM:
This option is not selectable. The system automatically provides both internal and external sounding (and dialer trigger) for an auxiliary alarm when the Auxiliary Function with alarm is selected below. In connection with the Programming Form for the ALERT III (Issue N4631V1 5/89), note the following: In the MISC. 2 position of the rotary switch on the No. 690 Programmer, slide switch E should always be set to the OFF position, regardless of the selection made for slide switch G.

DELAY TO "LIGHTS-ON" OUTPUT: (Check one) †

Same as for External Sounder
 Same as for Internal Speaker

AUXILIARY FUNCTION: (Check one)

** "Lights-On" Output Without Alarm Alarm

RESPONSE OF LIGHTS TO ENTRY WHEN ARMED "AWAY" (Check one) †

"Lights-On" Output No "Lights-On" Output

HOUSE I.D.:
 (Select any number from 00 thru 31 that is not used nearby.)

*Mandatory selection for UL Listed household fire/burglary use.
 **Non-alarm Auxiliary Function selection mandatory for UL Listed household fire/burglary installation.
 † Lights-on function not permitted in a UL Listed household fire/burglary installation.

TABLE B. (CONT)

DIALER TRIGGER CONFIGURATION: (Check one)

Entry/Exit Burglary, Perimeter Burglary, Interior Burglary, Police, Emergency, Transmitter Low Battery/Loss of Check-in Signal, Loss of AC Power, Fire

Burglary, Fire, Police, Emergency, Auxiliary, Transmitter Low Battery, Loss of Transmitter Check-in Signal, Loss of AC Power

WIRED LOOP FUNCTION: Entry/Exit, *Interior, Perimeter, Police, Emergency
(Check one)

‡If a wired loop is not used, program for "Entry/Exit" (see text for explanation).

*Select "Interior" only if a transmitter is also used in the Interior zone.

SIREN/BELL RESPONSE TO POLICE ALARM: Silent Audible
(Check one)

ALARMS TRIGGERED PER TRANSMITTER PER ARMED PERIOD: Multiple Single
(Check one)

TRANSMITTER I.D. ASSIGNMENTS:

| ZONE | TRANSMITTER I.D. NUMBERS | | |
|------------|--------------------------|----------------------|----------------------|
| | AVAILABLE | *ASSIGNED | |
| | | FIRST | LAST |
| Entry/Exit | 01-47 | <input type="text"/> | <input type="text"/> |
| Interior** | | <input type="text"/> | <input type="text"/> |
| Perimeter | | <input type="text"/> | <input type="text"/> |
| Fire*** | 48-58 | <input type="text"/> | <input type="text"/> |
| Auxiliary | 59-61 | <input type="text"/> | <input type="text"/> |

*Use initial zeroes where applicable
Leave blank if zone not used

**No. 5775 PIR DET/TX LIMITED TO 32-47.

***No. 5706 SMOKE DET/TX LIMITED TO 48-55.

NOTE: ID 32-47 HAS 3-MINUTE LOCKOUT BETWEEN TRANSMISSIONS (BATTERY SAVER).

V. PRELIMINARY INSTALLATION PROCEDURE

In order to obtain optimum performance of the system, it is necessary to have some understanding of the transmission characteristics of the radio signals used in the system. These transmission frequencies penetrate building materials such as wood and plaster, but the signal strength is more greatly reduced by concrete and brick, and these frequencies will not penetrate metal at all. It is, therefore, necessary to consider the effects of placement of various elements of the system with regard to the physical surroundings. In certain cases, it may be necessary to move either a transmitting unit or the No. 5720 Receiver/Control, to provide reliable operation of the system. In general, certain precautions should be observed.

Although either the No. 5621 or No. 5330 security consoles may be used, the following discussion assumes use of the No. 5621. Refer to the No. 5330 Installation Instructions packaged with that unit for comparable application information.

To avoid possible interference with the No. 5720 Receiver/Control, the No. 5330 Security Console should be located at least 10 ft (3M) from the No. 5720.

DO NOT YET MOUNT ANY OF THE SYSTEM COMPONENTS PERMANENTLY IN PLACE

1. The No. 5720 Receiver/Control should be located in a central location, at least a few feet (approximately 1M) above ground level. Basement installation is not absolutely precluded, but the operating range will probably be less and transmitters located outside the structure itself (e.g., in a detached garage) may not be received. A central location in a first floor closet is often preferable. To avoid possible interference with the No. 5720 Receiver/Control, all electronic devices such as VCRs, TV receivers/amplifiers, computers, as well as the No. 5330 Security Console, should be located at least 10 ft (3M) from the No. 5720.
2. The No. 5720 should not be located near large metal objects such as refrigerators, ranges, storage cabinets, etc. In no case should the No. 5720 be mounted to a metal wall, post or girder.
3. The No. 5720 should not be mounted on a concrete or brick wall if it can be avoided.
4. The transmitters should always be located at least four inches (100 mm) away from any substantial metal objects to avoid detuning effects. They obviously must not be located inside a metal structure, such as a file cabinet or safe, since there would be no penetration through the metal. Where protection of such a unit is required, a remote sensor should be utilized, and connected in the protective loop of a No. 5711 or 5715 unit.
5. The indoor range of the transmitters in most residential buildings is approximately 200 feet (60M). In some surroundings greater or lesser range may be obtained depending upon building construction and location of the transmitters relative to that of the No. 5720. Note, however, that receipt of consistent transmissions from each transmitter in its intended location *must* be verified, as indicated in steps 6 through 10 of "Preliminary/Location Test".
6. Transmitters should be installed only where the temperature is maintained between 32°F and 120°F (0° and 50°C). Do not locate a transmitter where it will be exposed to freezing temperatures or direct sunlight. If such areas need to be protected, run wires from the sensor to a transmitter located in a temperature controlled area.
7. No. 5706 Smoke Detector/Transmitters, if used, should be located in accordance with the guidelines supplied with them and the results of the preliminary tests described in the following section.
8. No. 5775 Passive Infrared Detector/Transmitters, if used, should be located in accordance with instructions that accompany them and the results of the preliminary tests described in the following section.

PRELIMINARY PROGRAMMING/LOCATION TEST

The following procedure is intended to provide a preliminary check on the system programming and to determine the suitability of proposed locations for the No. 5720 Receiver/Control and the transmitters, before permanent installation is made.

1. Place the No. 5720 Receiver/Control temporarily in its proposed location and:
 - a. Install the programmed PROM carefully in the PROM socket in the middle of the No. 5720's PC board (if available, a No. 692 PROM Insertion Tool should be used). Ensure that the PROM's index mark is toward the left, as indicated in Diagrams 1 and 7.

- b. **Connect the No. 5621 Security Console to the No. 5720, temporarily, via its four leads as indicated in Diagram 7. If a No. 5330 Console is used, locate it at least 10 ft (3 M) from the No. 5720.**
 - c. **Connect a 1K ohm resistor across terminals 12 and 13 if one is not already in place.**
 - d. **Install the antenna by guiding it into the grommated hole at top of cabinet and inserting it into the left screw terminal connector at the upper left hand corner of the receiver's circuit board. Tighten the screw to fasten antenna in place. The antenna must stand straight up and must not be bent in any direction.**
 - e. **Temporarily connect terminals 1 and 2 to the output terminals of No. 1324 transformer supplied, with enough wire to reach the nearest 120VAC outlet (do not plug in the transformer until step 3 that follows).**
2. **Connect the 6V battery to the No. 5720's battery connector cable.**
 3. **Plug the transformer into the 120VAC outlet. The green LED within the No. 5720 should light. The No. 5621's green READY and POWER indicator LEDs will light and its sounder will beep continuously. Enter the 4-digit access code, followed immediately by depression of the OFF function key. The sounder will silence.**
 4. **Temporarily place a jumper across the SUPERVISION TEST POSTS in the No. 5720 (See Diagrams 1 and 7). The No. 5621's CHECK indicator will light and the sounder will beep continuously if the audible option has been programmed. Otherwise, only visual annunciation of the CHECK condition will take place.**
 - a. **At the No. 5621, enter the 4-digit access code, followed immediately by depression of the OFF key. The sounder will stop, if programmed for audible annunciation.**
 - b. **Verify that all burglary and fire transmitter ID numbers programmed into the PROM are sequencing through the No. 5621's transmitter ID display (emergency/panic transmitters and No. 5727 Remote Wireless Keypad will not have an indication).**

Note: This step does *not* actually check if each transmitter is transmitting properly. Instead, it verifies that each transmitter ID is properly included in the PROM. If discrepancies are revealed, disconnect the battery, unplug the transformer, remove the PROM (with a No. 692-1 PROM Removal Tool, if available) and verify its programming by using a No. 699 or No. 690 PROM Programmer.
 5. **Remove the jumper from the No. 5720's SUPERVISION TEST POSTS.**
 6. **At the No. 5621, enter the 4-digit access code, followed immediately by depression of the TEST function key. The sounder will beep and the amber TEST indicator LED will light.**
 7. **Each transmitter's coding switches should have been set for a unique ID number, as previously described under "Programming the Transmitters" in Section III. Each transmitter should also have been previously identified (with a tag or piece of masking tape) to indicate its transmitter ID number and proposed location.**
 8. **Install the required battery in each transmitter as indicated thereon and in the General Specifications in Section XI. Battery access information for Nos. 5706, 5715, and 5775 is provided in the Installation Instructions accompanying those units. Refer to Diagram 5 for No. 5701, Diagrams 5 and 9 for Nos. 5711/5711WM, and Diagram 3 for No. 5727.**

After a transmitter's battery is installed, open circuit and short circuit the protective loop terminals on the transmitter and observe that its corresponding ID number will appear and then clear, respectively, from the display on the No. 5621.

Note: During the TEST mode, the sensitivity of the No. 5720's RF Receiver is automatically decreased, reducing the effective RF range of all transmitters by approximately 1/2. If the transmitted signals are properly received by the No. 5720, the No. 5621 will acknowledge proper reception with visual and audible annunciation. If no transmissions occur, the No. 5621 will beep once every 30 seconds as a reminder that the system is in this TEST mode
 9. **At each proposed transmitter location, force several (at least three) transmissions from the transmitter intended for that location while it is in the position it will occupy when installed and observe (or have an assistant observe) that audible and visual annunciation occurs at the No. 5621 each time a transmission is received at the No. 5720. When performing this test, do not hold the transmitter in your hand since this may cause a sharp reduction in the level of the transmission signal.**

In the case of the No. 5711 and 5715, the sensor loop wiring *must* be attached to the terminals. If successful transmissions cannot be obtained with these particular transmitters, contact the Ademco Technical Support Department.

Remember, the proposed location for a transmitter is acceptable if successive transmissions (at least three) consistently result in audible and visual annunciation at the No. 5621. At times, changing the transmitter location by only a few inches (50-100 mm) can mean the difference between a successful, and unsuccessful transmission. Occasionally, a new location may have to be selected for the No. 5720 Receiver/Control.

- a. No. 5727 will transmit whenever any of its numeric keys is depressed. Ensure that a transmission is received from each area where its usage is anticipated.
 - b. Nos. 5711, and 5715 will transmit whenever the circuit across the unit's screw terminals is closed or opened.
 - c. No. 5711WM will transmit whenever its associated magnet is brought close to or removed from the space between the wedge-shaped magnet positioning marks on its side (or if a jumper is connected and disconnected across its protective terminals if the magnet is not used with the transmitter).
 - d. No. 5706: This Smoke Detector Transmitter should be tested as described in the instructions that accompany the No. 5706. When so tested, the No. 5706 will transmit every 12 seconds.
 - e. No. 5775 will transmit when sensing motion (test with cover removed). Also refer to the instructions that accompany the No. 5775.
 - f. No. 5701 will transmit only when the unit's actuator button is depressed for at least one second. Walk throughout the premises to determine areas where "successful" and "unsatisfactory" transmission paths exist, and so inform the subscriber of these particular areas.
10. When satisfactory locations have been determined, disconnect the No. 5720's plug-in transformer, disconnect the leads at the battery, and proceed with the permanent installation. Transmitter batteries need not be removed.

Note: When the Test mode is exited, the sensitivity of the No. 5720's receiver is automatically returned to its normal operating sensitivity (which is 2 times that which exists in the Test mode), providing a 2-to-1 transmission margin for each transmitter location established during the Test mode.

VI. INSTALLING No. 5720 AND SECURITY CONSOLES

INSTALLATION AND WIRING OF No. 5720 RECEIVER/CONTROL (Refer to Diagram 7)

Important: *Do not plug in the transformer or connect the battery until all system wiring is complete and ready for test and checkout.*

Use of twisted wiring is recommended for all runs for immunity to unwanted signals.

1. Permanently mount the No. 5720 in the location selected (assuming all previous transmission tests were successful).
2. Make terminal block connections in accordance with Diagram 7 and the following:

Terminal(s):

Connections:

-
- | | |
|----------|---|
| [1], [2] | 12VAC INPUT: Connect the output terminals of No. 1324 Transformer, but do not plug in the transformer. For UL Listed household fire/burglary installations, connect a battery test switch (Ademco No. 1206) as indicated in the Summary of Connections diagram (Diagram 7). |
|----------|---|
-
- | | |
|-----|--|
| [3] | SIREN DRIVER POWER INPUT: See Diagram 8 to determine appropriate voltage input for siren configuration used. +6V may be obtained from terminal 20, +12V* from terminal 16, or power may be provided from an external source (in which case, connect (+) to terminal 3 and (-) to terminal 17 in the No. 5720). *12 volt selection desirable if alarm sounder operation is to be independent of the state of battery charge. |
|-----|--|
-
- | | |
|-----|--|
| [4] | YELLOW LEAD OF SECURITY CONSOLE (and optional consoles, if used, with separate wiring run from this terminal). |
|-----|--|
-
- | | |
|-----|-----------|
| [5] | NOT USED. |
|-----|-----------|
-
- | | |
|-----|---|
| [6] | ARM/DISARM STATUS OUTPUT for control of accessories. 0VDC when armed, +6VDC (5mA max) when disarmed. |
|-----|---|
-
- | | |
|-----|---|
| [7] | "ALL LIGHTS ON" OUTPUT for activation of X10 (BA284) Burglary Alarm Interface or Strobe output for activation of No. 4177 Relay Module. Open circuit when off, 68 ohm path to ground when the output is active. The output remains until the system is turned OFF. X10 (BA284) and No. 4177 are not UL Listed for household fire/burglary use with this system. |
|-----|---|
-
- | | |
|-----|--|
| [8] | GREEN LEAD OF SECURITY CONSOLE (and optional consoles if used, with a separate wiring run from this terminal). |
|-----|--|
-
- | | |
|-----------------|--|
| [9], [10], [11] | BELL RELAY (DRY) CONTACTS (Rating: 2A* max at 28VDC). Center arm (10) transfers from 9 (N.C.) to 11 (N.O.) on alarm: steadily for "Burglary" or "Audible Panic" and pulsing for "Fire" or "Auxiliary". An optional bell may be powered from terminal 11, with +6V obtained from terminal 20 (e.g., for AD8 or AD10 Bell) or +12V** obtained from terminal 16 (e.g., for AD8-12 or AD10-12 Bell), and wired to terminal 10. *Bells and speakers (see terminals 14, 15) each drawing 2A cannot be used together. Total available alarm current is limited to 2A. **12 volt selection desirable if alarm sounder operation is to be independent of the state of battery charge. |
|-----------------|--|
-

[12], [13] **WIRED ZONE (if used)*:** Run a twisted pair of wires to all protection points in the zone and terminate with a 1000 ohm end-of-line resistor. Maximum permissible loop resistance is 1300 ohms (including EOL resistor). No. 5720 is supplied with this zone set for normal (250 msec) response to disturbances. For fast response (10 msec) to fast-acting devices (such as vibration contacts, glass protection devices and photoelectric units without built-in delay), cut the GREEN jumper at the upper right hand corner of the No. 5720's PC board. This zone may be PROM programmed as an Entry/Exit, Perimeter, Interior, Police, or Emergency zone.

As mentioned earlier, the wired zone may be used as an Interior zone only if one or more transmitters are also included as interior protection.

***IMPORTANT:** If a wired zone is not going to be used, program the PROM for use as Entry/Exit, and connect a 1K ohm end-of-line resistor across terminals 12 and 13. This will ensure that a low battery condition in a Remote Wireless Keypad will produce a display at the Console ("00" and "LOW BAT").

[14], [15] **EXTERNAL SIREN SPEAKER:** Nos. 705, 705-8, 705-820*, 713, Speaker(s) may be used. Depending on the voltage selected to power the built-in siren driver and the speaker being used, speakers may be connected singly or in parallel (for concentrated sound intensity) at full output voltage, or in series (for reduced sound intensity but spread over a wider area) with each speaker receiving half voltage. Diagram 8 indicates allowable speaker configurations that stay within the siren driver's current limit of 2A (total for sirens and/or bells, if used). See terminals 9, 10, 11.

* Not UL Listed for household fire/burglary use with this system.

[16] (+) **UNREGULATED POWER OUTPUT:** 12VDC, 2A (max). May be connected to terminal 3 as power input to siren driver, to terminal 10 as power input for a 12V bell, or to the (+) terminal of the X10 (BA284) Burglary Alarm Interface (AC Line Carrier Transmitter Module). *The X10 (BA284) is not UL Listed for household fire/burglary use in this system.*

[17] (-) **EARTH GROUND:** Connect this terminal to a proper earth ground to obtain maximum immunity to malfunction or damage due to electrostatic discharge and lightning transients. This terminal also used for power ground (-) connection for optional Digital Communicator.

[18] (-) **GROUND RETURN (CONSOLES):** Connect BLACK lead of security console to this terminal. If more than one console is used in the system, use a separate wiring run from each console to terminal 18.

[19] (+), [20] (+) **REGULATED 6VDC OUTPUT:** Connect RED lead of security console (and optional consoles, if used, with separate wiring run from this terminal) to terminal 19 (or 20). Permissible maximum continuous total current from these terminals and pin 1 of the Dialer Trigger Connector is 500mA (each No. 5621 draws 120mA and each No. 5330 draws 105 mA). On alarm, a maximum of 2A is available from terminals 19 and 20 combined.

DO NOT PLUG IN THE TRANSFORMER OR CONNECT THE BATTERY YET.

3. If a digital communicator (e.g., No. 678) is to be used, connections to the communicator should be made from the DIALER TRIGGER CONNECTOR via a connector cord (No. SA5720-2) supplied with the No. 5720. For optimum protection from the effects of electrostatic transient discharges (e.g., static, lightning), the digital communicator should be mounted in the same cabinet as the No. 5720, with both the cable and telephone wires dressed away from the No. 5720 control board.

Eight different dialer trigger outputs (in two different configurations) and 6VDC power are available from this plug-in connector block to accommodate a digital communicator (e.g., No. 678). Each output goes high (+6VDC, 1mA max) when activated.

Caution: To avoid possible short circuits, all connections to the communicator should be made first before the connector cord is plugged into the connector block.

| Connector Block Pins (from left to right) | Connector Cord Conductor Color | Description |
|---|--------------------------------|--|
| 1 | BROWN | +6VDC Power Output for Communicator* |
| 2 | -- | Not used |
| 3 | ORANGE | Not used |
| 4 | YELLOW | Burglary Alarm (or Perimeter Burglary Alarm) |
| 5 | GREEN | Fire Alarm |
| 6 | BLUE | Police Alarm (approx. 3-5 sec. momentary HIGH for Ambush and Silent Panic) |
| 7 | VIOLET | Emergency Alarm |
| 8 | GRAY | Auxiliary Alarm (or Interior Burglary Alarm) |
| 9 | WHITE | Low Battery (or Low Battery/Loss of Check-in Signal) |
| 10 | BLACK | Loss of Check-in Signal (or Entry/Exit Burglary Alarm) |
| 11 | RED | AC Power Loss |

* Note: (+) DC power to the communicator must be provided from pin 1 of this plug-in connector block and no other internal source; however, (-) DC power must be taken from terminal 17 (earth ground terminal) on the 5720 board.

ALL INTERCONNECTIONS MUST BE MADE USING U.L. LISTED LIMITED ENERGY CABLE. IF FIRE PROTECTION IS IMPLEMENTED, FOLLOW INSTALLATION REQUIREMENTS OF NFPA STANDARD No. 74 (National Fire Protection Association, Batterymarch Park, Quincy, MA 02269.)

TWISTED WIRING IS RECOMMENDED FOR ALL RUNS.

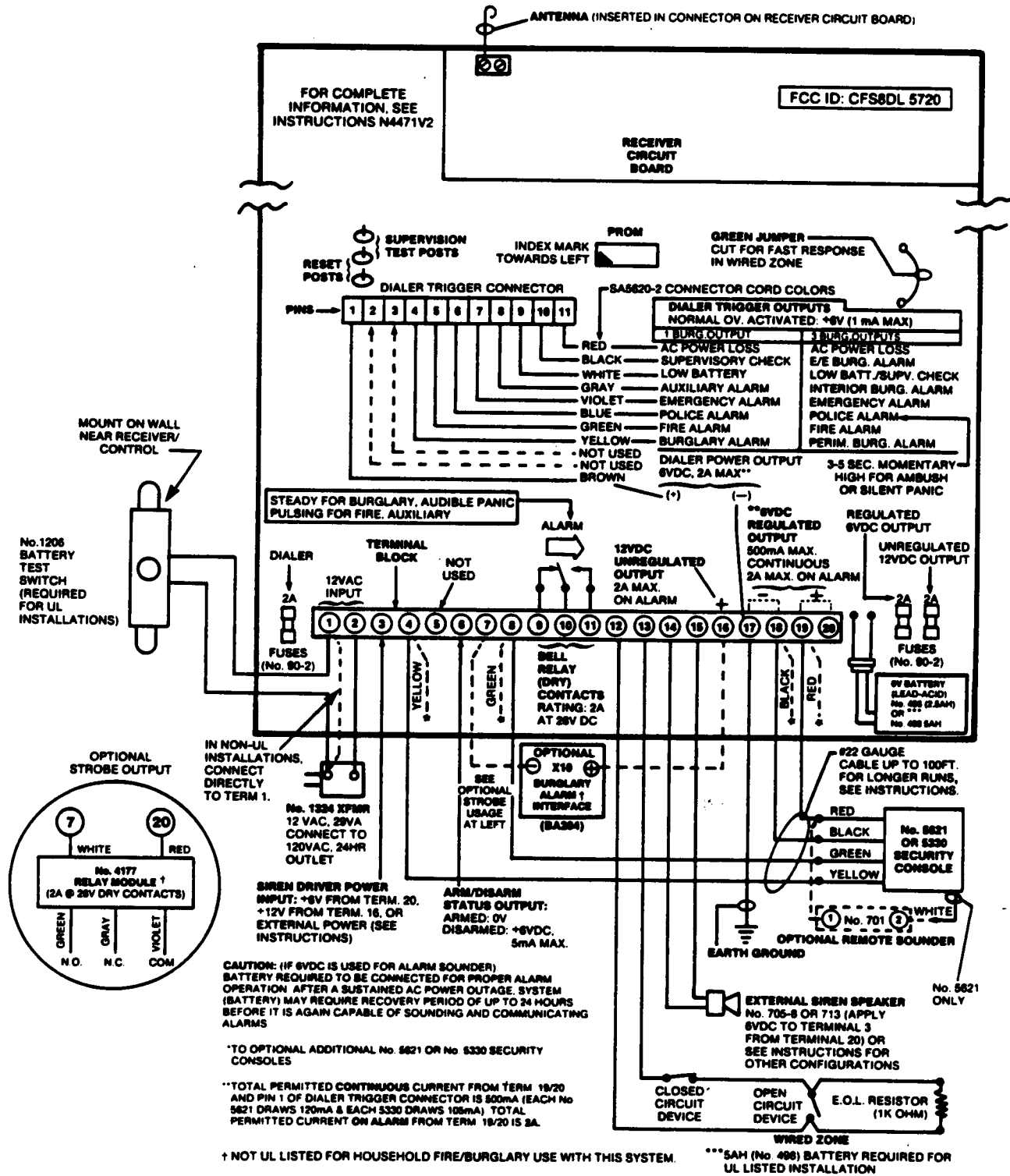

Diagram 7. SUMMARY OF CONNECTIONS

INSTALLATION AND WIRING OF No. 5621 SECURITY CONSOLE

1. Select a location for the No. 5621 that will be convenient for the entering of system commands and the receiving of the various visual and audible system signals.
2. Run wiring for connection of the No. 5621 to the No. 5720 Receiver/ Control. Use a 4-wire run (See Diagram 7). A maximum of 2 more No. 5621's (if used) may be connected in parallel with the first, as indicated in Diagram 7, with a separate wiring run from the receiver/control. Twisted wiring is recommended for all runs.

For runs of less than 100 feet, 2 pairs of #22 conductors may be used. For longer runs, the wire size to be used depends upon the distance from the No. 5720. Use the following table to determine the correct wire size.

| DISTANCE TO No. 5621 | WIRE SIZE |
|----------------------|-----------|
| to 100' | #22 |
| 100' to 200' | #20 |
| 200' to 300' | #18 |

- 3A. Surface mount the No. 5621 as follows: Snap off the front cover of the No. 5621, after pushing-in the lower tab. Move up the keypad retaining tab above the keypad illumination bulb to free the keypad and PC board assembly. Remove the assembly. Disconnect the speaker cable by unplugging the brown connector from the PC board. Slide out the transmitter data drawer to expose one of the mounting holes and use the back of the No. 5621 as a template to locate the 3 screw mounting holes (2 keyslot) and the wiring access hole (see note on alternative wiring access hole, below). Drill the necessary holes, route the wiring in the wall through the access hole and mount the back of the No. 5621. Splice the wire run to the No. 5621's wires and plug in the speaker cable. Push the interface wiring back into the wall and snap in the keypad and PC board assembly. Snap on the front cover.

Alternatively, if mounting with only two screws via the keyslot holes on the back of the unit is acceptable, the mounting template supplied with the No. 5621 may be used to locate the two holes and the wiring access hole. In this case, the PC board need not be removed.

Note: If using the No. 4157BP-WH Backplate for mounting the No. 5621 over an electrical box, break out the knockout that is centrally located in the back of the No. 5621 and use this hole for the wiring. The No. 4157BP-WH is not UL Listed for household fire/burglary use with this system.

- 3B. Recess mount the No. 5621 with the optional No. 4100MK (plastic) or 5600MK (metal picture frame) mounting kit, following the instructions provided with the kit. The 4100MK and 5600MK are not UL Listed for household fire/burglary use with this system.
4. An optional No. 701 Speaker may be added to each No. 5621 as a remote sounder if desired. Extend a connection from the No. 5621's WHITE and RED leads to the No. 701's screw terminals (not polarized) as shown in Diagram 7.
5. Enter the appropriate transmitter data (zone, location, etc.) on the data cards (located in the transmitter data drawer on the right side of the No. 5621) in accordance with the transmitters' assigned ID numbers and proposed locations.

| DRIVER INPUT VOLTAGE | ALLOWABLE SPEAKER CONFIGURATIONS | | | |
|----------------------|----------------------------------|-------------------------------------|-------------------------|---------------------------------------|
| | No. 705 (4 OHM, 5W) | No. 705-8, 737-10WH (8 OHM, 13W) | No. 713 (8 OHM, 30W) | No. 705-820, 737-20WH (8 OHM, 20W) |
| 6VDC | C.D. | A.B.C.D. | A.B.C.D. | A.B.C.D. |
| 12VDC | DO NOT USE | C.D. | A.C.D. | A.C.D. |

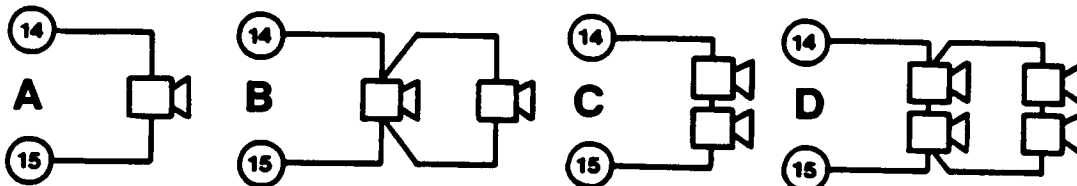

Nos. 737-10WH, 705-820, and 737-20WH are not UL Listed for household fire/burglary use with this system.

Diagram 8 . SIREN SPEAKER CONFIGURATIONS

VII. INSTALLING THE TRANSMITTERS

Install the transmitters in locations selected (and previously tested for satisfactory transmission paths), as follows:

1. General:

- a. Set each transmitter's coding switches as described previously (if this has not already been done).
- b. Make sure that the required battery has been installed in each transmitter, if this has not already been done. Battery requirements are shown on the unit and listed in *Section XI, GENERAL SPECIFICATIONS*.

2. No. 5727 Portable Remote Keypad/Transmitter:

The unit may be left unmounted, resting on a table, countertop or other surface, or carried in a pocket or purse (a No. 5634 Belt Clip is optional).

3. No. 5711 or No. 5711WM (without the use of its magnet) as a Door/Window Transmitter:

The No. 5711 and No. 5711WM are slimline units which lend themselves particularly to installation on narrow window frames or other mounting surfaces (these units are less than 1-3/8" (35 mm) wide).

The units contain terminals for the connection of a protective loop which may include such sensors as magnetic contacts, foil, or devices that provide a dry contact opening compatible with these units.

Note: If the accompanying magnet is used with the No. 5711WM (see below), the terminals must not be used for connection of a protective loop (leave the terminals unconnected and do not jumper).

The No. 5711/5711WM may be set for either N.O. or N.C. circuit applications by the appropriate setting of position 12 on its DIP switch. In addition, a fast response option may be selected (see instructions accompanying these transmitters).

Closed loop resistance should be limited to 10,000 ohms maximum.

When connecting loop wires to the terminals, avoid routing the wires near the printed circuit board components, as reduced transmission range may result. Note that this transmitter has breakout areas in its plastic housing for surface wiring access, if desired.

Mounting Procedure:

Remove the cover (raised end first) and mount with 2 screws (use slotted opening at one end and either round hole at other end) or use double-sided tape. Make wiring connections and replace the cover (narrow end first). See Diagram 9.

4. No. 5711WM (with the use of its magnet) as a Door/Window Transmitter:

Follow the same mounting procedure described in (3) above, *remembering that the loop terminals cannot be used if the accompanying magnet is employed*. Mount the magnet on the door (or window) so that the magnet is adjacent to the wedge-shaped alignment marks that appear on the right side of the transmitter's cover. Maximum gap between magnet and transmitter should be 1/2" (12 mm). When the door (or window) is closed, the magnet will keep a reed switch within the transmitter closed. Recommended locations and installation details for door mounting are shown in Diagram 10, although other acceptable locations and orientations will suggest themselves to the installer.

5. No. 5715 Universal Transmitter:

Complete information on the installation of the No. 5715 accompanies that unit.

6. No. 5775 Passive Infrared Detector/Transmitter:

Complete information on the No. 5775 accompanies that unit.

7. No. 5706 Smoke Detector/Transmitter:

Complete information on the installation of the No. 5706 accompanies that unit.

8. No. 5701 Portable Emergency (Panic) Transmitters:

No installation is required. This transmitter may be carried about the protected area in a pocket or purse (a No. 5634 Belt Clip is optional). If desired, however, the transmitter(s) may be mounted in any convenient location via a slotted mounting hole in the back of the unit.

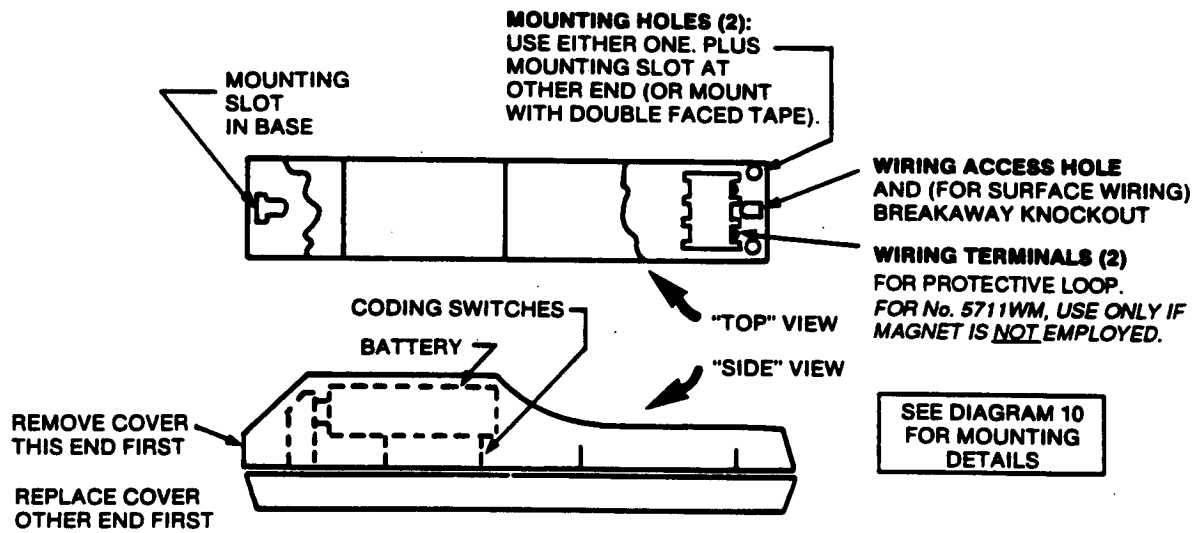
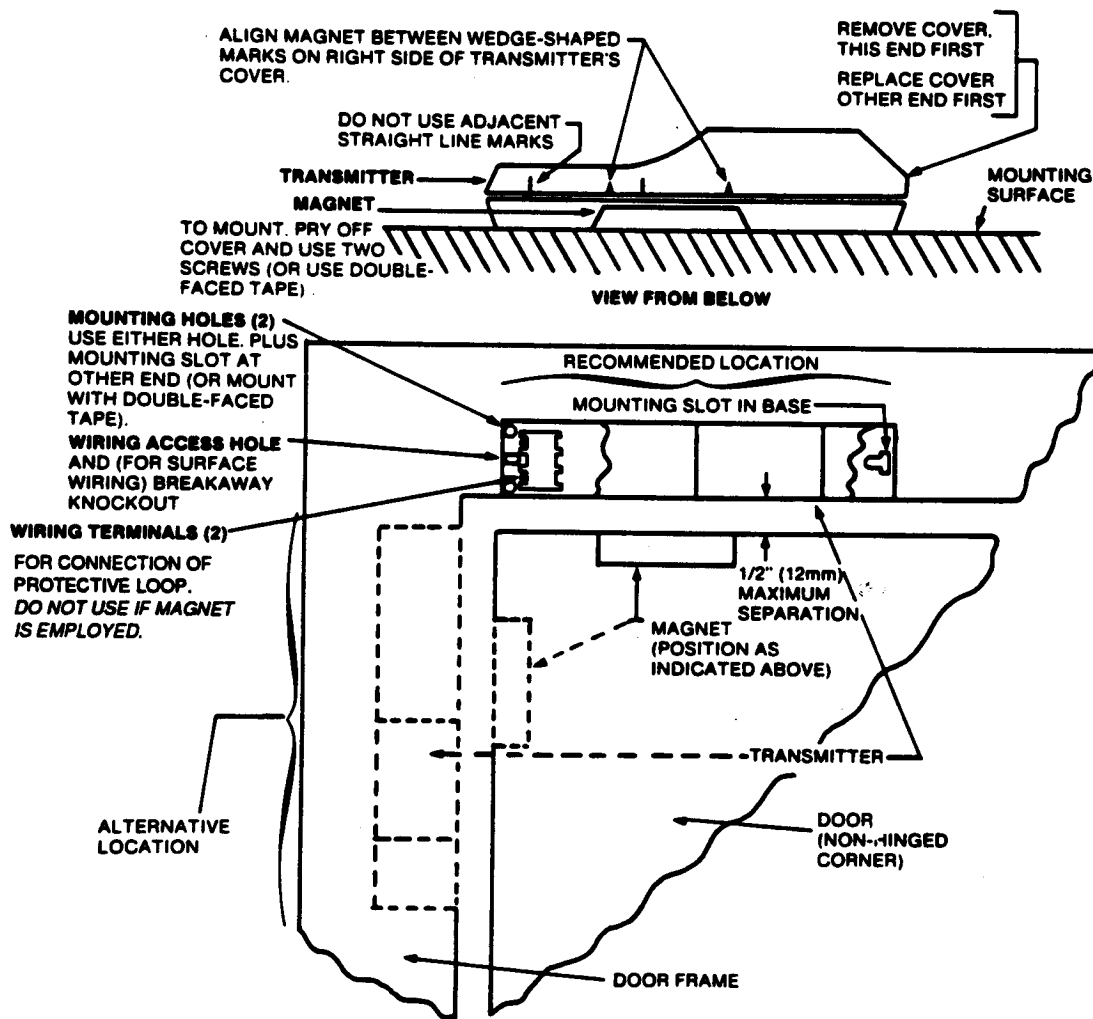

Diagram 9. No. 5711 & 5711WM INSTALLATION DETAILS



Note: Transmitter may be oriented in any position, as long as magnet is located adjacent to pair of wedge-shaped alignment marks on transmitter, with no more than 1/2" separation between magnet and transmitter.

Diagram 10. No. 5711WM MOUNTING DETAILS

VIII. SYSTEM FINAL TEST AND CHECKOUT

Perform the following tests after the system installation is complete:

1. **Connect the battery to the No. 5720's battery connector cable.**
2. **Plug the transformer into a 120 VAC outlet that is active 24 hours a day (not under switch control). The green LED within the No. 5720 will light. The No. 5621's green READY and POWER indicator LEDs will light and its sounder will beep continuously. Enter the 4-digit access code followed immediately by depression of the OFF function key. The sounder will silence.**
3. **Temporarily place a jumper across the SUPERVISION TEST POSTS in the No. 5720 (see Diagram 7). The No. 5621's CHECK message will light and the sounder will beep continuously (if audible annunciation was programmed).**
 - a. **At the No. 5621, enter the 4-digit access code followed immediately by depression of the OFF function key.**
 - b. **Verify that all burglary and fire transmitter numbers programmed into the PROM are sequencing through the No. 5621's transmitter ID display (emergency/panic and portable wireless keypad transmitters will not have any indication).**
4. **Temporarily unplug the transformer (the System's only source of power is now the battery connected in step 1 above). Note that the green POWER indicator LED on the No. 5621 goes out and the sounder begins beeping continuously (if audible annunciation was programmed). Also check communicator (optional) operation. To silence sounder, enter the 4-digit access code followed immediately by depression of the OFF function key.**
5. **Plug the transformer in again. The green POWER indicator LED will not be lit. Enter the 4-digit access code, followed immediately by depression of the OFF function key to turn it on.**
6. **Check the operation of the No. 5621's (or 5727's) data entry keys as follows:**
 - a. **At the No. 5621, assign a temporary access code of 1-2-3-4, using the procedure described in the User's Manual, and verify the new code by entering it, immediately followed by depression of the OFF function key. The No. 5621 should beep once.**
 - b. **Change the temporary access code to 5 6 7 8 and verify it as before.**
 - c. **Repeat, using 7-8-9-0.**
 - d. **At each No. 5727, repeat steps a, b and c to check the unit's data entry keys. Listen for the No. 5621's (or an optional nearby No. 701's) beeps since the No. 5727 produces no sound.**
7. **Check the operation of the No. 5621's manual alarm keys as follows:**
 - a. **At the No. 5621, push both FIRE alarm keys at the same time. The No. 5621's sounder and the system's siren/bell will sound for 1/60th of their normal timeout duration (all times are divided by 60 while the jumper of step 3 is in place). To silence the siren/bell and sounder, enter the 4-digit access code, followed immediately by the depression of the OFF function key. Check operation of the communicator, if used.**
 - b. **Repeat the above with the EMERGENCY and AUXILIARY (if programmed for alarm) alarm keys and (if audible POLICE alarm has been selected) POLICE alarm keys as well.**

| Function | Siren Sound | Bell Sound |
|-----------|--------------------------|------------|
| FIRE | INTERRUPTED RAPID HI-LO | PULSED |
| AUXILIARY | INTERRUPTED RAPID HI-LO* | PULSED* |
| EMERGENCY | RAPID OR SLOW HI-LO | STEADY |
| POLICE | RAPID OR SLOW HI-LO** | STEADY** |

* Only if AUXILIARY programmed for alarm (and No. 5621's sounder only, if "Internal Sounder Only" option has been selected).

** Only if audible POLICE alarm programmed.

8. **Remove the jumper previously connected across the Supervision Test Posts during step 3.**
9. **Test the operation of all transmitters, as follows:**

- a. **Place system in TEST mode** by entering access code, immediately followed by depression of the TEST function key.

Reminder: In the TEST mode, the RF receiver sensitivity is deliberately reduced by 50%, thereby ensuring a 2 to 1 safety margin for the test performed at each transmitter location. The No. 5621 will beep once every 30 seconds *if no transmitter is activated* (as a reminder that the system is in the TEST mode and that all protection is turned off). The No. 5621 will beep at least once, together with a visual display of the ID number, each time a transmitter is activated.

- b. **Activate each door and window burglary transmitter** (fault a contact in its protective loop) and listen for the No. 5621 to beep as each is faulted. While each is faulted, its corresponding transmitter ID number will appear on the No. 5621's display in sequence with other faulted transmitters. Force several (at least 3) transmissions at each location and *ensure that there is a consistent resultant audible and visual display on the No. 5621*. With all transmitters faulted, observe that all numbers are sequencing through the display. Then close all transmitter loops and observe that the display is off. The No. 5621 will beep as each loop is closed.
- c. **Walk test each No. 5775 used** and observe both visual and audible annunciation at the No. 5621 each time the No. 5775 trips. The appropriate transmitter ID number will be displayed by the No. 5621 while the unit is faulted.

Note: The No. 5775 has a walk test LED that is active only when the unit's cover has been removed. Also, with the cover in place, the unit's "hold off" feature limits transmissions to once every 3 minutes (approx.). Therefore, conduct preliminary walk tests with the cover removed, and a final walk test with the cover in place. Additional information accompanies the No. 5775.

- d. **Push and hold the test button on each No. 5706 smoke detector used.** In 2 to 20 seconds the detector's internal horn will start sounding, followed 12 seconds later by visual and audible annunciation at the No. 5621, followed by audible beeps every 12 seconds thereafter, concurrent with the unit's ID being displayed on the No. 5621, as long as the button is kept depressed. Release the button after at least 4 audible responses have sounded. The detector's audible alarm will continue up to 20 seconds. The unit's transmitter ID will then be cleared from the display on the No. 5621 console, concurrent with an audible response from the console. Additional information accompanies the No. 5706 Smoke Detector/Transmitter.
 - e. **Push the button on each No. 5701 Emergency (Panic) transmitter for at least one second.** The No. 5621 should beep as each button is pushed. The number 62 or 63 will appear on the No. 5621 display as long as the button is held depressed. The display will clear concurrent with audible beeps as the button is released.
 - f. **Turn off the TEST mode** by entering the 4-digit access code, followed immediately by depression of the OFF function key. This will return the system to its full RF range.
10. **Disturb a contact in the wired protective zone** (if connected to screw terminals 12 and 13 in the No. 5720). Push the READY function key on the No. 5621 and observe that "00" is shown on the number display. Restore the disturbed contact and observe that "00" is no longer displayed.
 11. **Arm the System in the AWAY mode** (code plus AWAY), and simulate leaving the premises via the Entry/Exit zone.
 12. **Simulate entering the premises via the entry/exit zone** (after allowing enough time for the exit period to end after Step 11). Refer to the User's Manual for information regarding the various warning sounds which will occur upon entry. To silence warning tones (beeps), enter Code plus OFF.
 13. **Test the other ARM/DISARM functions described in the User's Manual** (in particular, arming HOME, arming HOME with a BYPASS, and arming INSTANT).
 14. **Test the No. 5727 Remote Portable Wireless Keypad** by using it to arm and disarm the system, as described in the User's Manual, bearing in mind that the keypad does not include status indicator lights. Audible confirmation of arming and disarming will be provided by the No. 5621 (3 beeps after HOME arming, and 1 beep after disarming). The "Lights On" and audible Emergency functions (if used), as well as the CHIME feature, should also be checked from the keypad. Remember that the LIGHTS key, when used to trigger "Lights On" or an audible alarm, must be depressed for a period of at least 2 seconds.

IX. TURNING SYSTEM OVER TO USER

1. Fully explain the operation of the system to the user by going over each of its features as well as the User's Manual supplied.
2. In particular, explain the operation of each zone (entry/exit, perimeter, interior, panic and fire) including the ARM/DISARM, TEST and CHECK/LOW BAT functions.
3. Encourage the user to find and remedy any unintentionally disturbed transmitters so as to avoid having to bypass them when arming.
4. Instruct the user in how to change his own transmitter batteries and clear the LOW BAT display from the No. 5621 should it appear. Make sure the user understands the importance of changing a transmitter battery within 30 days (within 7 days for burglary transmitters that are activated on a frequent daily basis) after a LOW BAT indication appears.

Alternatively (and preferably), battery replacement may be scheduled and done by the service company (see "To the Installer" below).

TO THE INSTALLER

Regular maintenance and inspection (at least annually) by the installer and frequent testing by the user are vital to continuous satisfactory operation of any alarm system.

The installer should assume the responsibility of developing and offering a regular maintenance program to the user as well as acquainting the user with the proper operation and limitations of the alarm system and its component parts. Recommendations must be included for a specific program of frequent testing (at least weekly) to insure the system's proper operation at all times.

Transmitter Battery Replacement:

Replacement of Transmitter batteries may be done by the user, but preferably it should be scheduled and done by the service company. Standard alkaline batteries should be replaced at least annually*, or after a LOW BATTERY indication (within the interval prescribed in *Section XI, GENERAL SPECIFICATIONS*, for the particular transmitter), whichever occurs sooner.

To turn off the Low Battery indication, replace the weak battery. Approximately one second later the transmitter will automatically transmit a check-in signal. If the replacement battery is a good one, the LOW BAT indication will clear from the display. To restore the LOW BATTERY output trigger, turn burglary protection on and then turn off.

*The battery replacement period may be extended up to 5 years if No. 465 Lithium batteries (Kodak U9VL) are used (5-year service not yet approved in a UL Listed installation).

Receiver/Control Battery Test:

For UL Listed household fire/burglary installations, a Battery Test switch (Ademco No. 1206) must be installed next to the Receiver/Control (wired as shown in Diagram 7) so that the backup battery in the system can be tested periodically (at least weekly).

The test procedure is then as follows:

1. Place the system in the Test mode by entering the access code followed by depression of the TEST key (the console will beep twice as it enters the Test mode). The console will beep once every 30 seconds as a reminder that the system is in the Test mode (if no transmitters are activated).
2. Check that the POWER light on the console is on, indicating the presence of AC power in the system.
3. Momentarily depress the Battery Test switch located near the Receiver/Control.

If the battery is operational, the POWER light will extinguish, but the system will remain in the Test mode. To restore the POWER light, enter the access code and depress the OFF key (the system will also exit the Test mode).

If the battery is weak, or not present, the system will reset and the console will beep continuously. To restore the system and silence the beeping, enter the access code and depress the OFF key.

X. TROUBLESHOOTING

BASIC TROUBLESHOOTING GUIDE

A system with a properly programmed PROM and properly coded transmitters is assumed in the following.

Trouble 1: No. 5621's POWER LED IS OFF (INTERIOR SOUNDER WILL BEEP CONTINUOUSLY AFTER 30 MINUTES)

Cause: AC Power Loss.

Remedy: Check transformer for insertion in live AC outlet.
Silence sounder (if beeping) by entering access code followed by depression of OFF function key.
If AC is off less than PROM selected interval, POWER LED will relight when AC restores. If AC is off longer than PROM selected interval, relight LED (when AC has been restored) by entering access code followed by OFF.

Trouble 2: "CHECK" MESSAGE DISPLAYED ON No. 5621 AND INTERIOR SOUNDER BEEPING

Cause: No. 5720's receiver has not received any regular transmissions during the Check-In interval from burglary or fire transmitter indicated on No. 5621's display.

Remedy: Silence sounder by entering Code plus OFF.
Examine indicated transmitter to determine whether it has been removed or relocated. Inspect transmitter's battery to ensure it is properly connected and making good contact.
With burglary protection off, force a transmission from the transmitter in question and attempt to turn off CHECK message as described in Section II, item, 13. If CHECK display can't be cleared, or if it clears and later recurs, check the margin of the transmission path by placing the No. 5720 in the TEST mode and by activating the sensor associated with the transmitter. The transmitter may have to be relocated if the test is unsuccessful.

Trouble 3: "LOW BAT" MESSAGE DISPLAYED ON No. 5621 AND INTERIOR SOUNDER BEEPING*

Cause: Weak transmitter battery (approx. 30 days of life remains, but see *Section XI, GENERAL SPECIFICATIONS*, for replacement recommendations)

Remedy: Silence sounder (if necessary) by entering Code plus OFF.
Replace battery of transmitter indicated. Then turn off LOW BAT indicator as described previously in "TO THE INSTALLER".

Cause: Transmitter located where temperature drops below 32°F (0°C)

Remedy: Move transmitter to climate controlled location and, if possible, extend sensing circuit to protected opening.

*In a non-UL Listed Household Burglary application, annunciation may have been programmed for visual only (no audibles).

Trouble 4: "CHECK" AND "LOW BAT" MESSAGES BOTH DISPLAYED ON No. 5621 AND INTERIOR SOUNDER BEEPING*

Cause: Battery in transmitter too weak for reliable transmission.

Remedy: Silence sounder by entering Code plus OFF.

Replace battery in indicated transmitter.

Then turn LOW BAT and CHECK indicators off simultaneously by forcing a transmission and entering the access code followed by depression of the OFF key. Check the transmission path by placing the No. 5720 in the TEST mode as described for Trouble 2, and by testing the transmitter.

- * In a non-UL Listed Household Burglary application, annunciation may have been programmed for visual only (no audibles).

Trouble 5: FALSE ALARMS

Cause: Sensor(s) not properly installed or connections bad.

Remedy: BURGLARY: Check protective circuit or sensor associated with transmitter(s) causing alarm (as indicated by display on No 5621).

PANIC: Be sure panic transmitter's button is not accidentally pressed.

FIRE: Be sure detectors are placed in areas where they will not false-trigger. See instructions accompanying detectors.

Cause: Nearby Installation has similar system set to same House ID.

Remedy: Check neighbors. Free space (no obstruction) range of system can be in excess of 2000 feet (600m). Change House ID if necessary.

SUPPLEMENTARY TROUBLESHOOTING GUIDE

PROBLEMS AND REMEDIES

No. 5621 SECURITY CONSOLE

1. Auxiliary function keyed from console will not trip dialer.

Check PROM - auxiliary function must be programmed for external audible in order to obtain a dialer trigger output (permissible on non-UL Listed fire/burglary installation only).

2. "OC" is displayed and the console sounder stays on continuously.

Check yellow wire from console to the control's terminal 4 for break in wire or loose connection at terminal 4.

Connect known good console in parallel to check for the same condition on it.

Remove batteries from each transmitter (one by one) until "OC" turns off. Replace the last transmitter from which the battery was removed.

3. "OC" and the console sounder come on for a few seconds, then turn off, and then come back on again, etc.

Remove batteries from each transmitter (one by one) until "OC" turns off. Replace the last transmitter from which the battery was removed.

4. Two or more transmitters display CHECK after installation appeared to be working. Also the transmitters in question do not result in audible acknowledgment when activated in the TEST mode.

Check for a strong RF interference or a runaway transmitter (one that is transmitting constantly). Place the No. 5720 in the TEST mode. Take a known good window/door transmitter with proper House and Unit ID Code, install a 9V Battery and connect its loop terminals to a No. 5625A Automatic Contact Operator. Bring next to antenna on 5720 receiver to establish receipt of audible beeps from the security console. Take transmitter and walk away from receiver/control until no audible acknowledgment is heard.

If this occurs at a relatively shorter distance than any of the installed transmitters are from the 5720,

strong RF interference from an electric or electronic device in the premises may be the cause. Disconnect all suspected devices in the premises one at a time, and repeat the above procedure to determine if such a device is the cause of the reduced transmission range. Include any of the installed transmitters in the test to determine if one of them is a runaway transmitter.

5. One transmitter displays CHECK.

Test the location with a known good panic transmitter (No. 5701) using the system's TEST mode. If the results are poor, relocate transmitter to a better position or reposition furniture or appliances that may be causing the problem.

6. Console does not respond to commands or code must be entered many times before it responds.

Test with known good 5621 console, or 5727 first to determine if these units function. Change problem keypad. If the first test doesn't work, check for possible runaway transmitter.

7. Console displays "OC" plus random numeric characters and beeps.

Replace No. 5720.

8. Display shows "00" and alarm trips when arming HOME or AWAY.

Reprogram PROM - *do not program wired zone for auxiliary function in Misc. 3.*

No. 5720 RECEIVER CONTROL:

1. "NOT READY" condition (Green Indicator not lit) persists after a Fire or Auxiliary alarm.

Obstruction is present which has allowed alarm signals to reach the Receiver/Control, but which has blocked the transmitter's restore signal. Look for filing cabinets, etc., or other metal obstruction as a possible cause. Try changing the location of the transmitter if possible.

To restore system to "Ready" state, temporarily short the RESET posts in the Receiver/Control. *Temporary* remedy for the end user is to force-arm by bypassing the transmitter (its ID will be displayed) that is causing the problem. This is not a true bypass in that alarm signals from a fire or auxiliary alarm transmitter so "bypassed" *will* be processed.

2. During the TEST mode, very few transmitters yield the 2-beep acknowledgment.

Relocate No. 5720 to a central or preferably a higher location.

3. After installation has been working for some time, multiple transmitters display a CHECK condition.

Check for large metal objects within 3 feet (1M) of the No. 5720 antenna.

Check transmission path to receiver using a known good panic transmitter (No. 5701) operating at the locations of the transmitters exhibiting a CHECK condition.

TRANSMITTERS Nos. 5711, 5711WM, 5715:

1. With No. 5720 Receiver/Control in TEST mode, activation of a transmitter will produce 2 beeps from the console but no display.

Check DIP switches #6 through 11 for the correct transmitter ID code. Reposition switches to assure proper setting.

2. With No. 5720 Receiver/Control in the TEST mode, there are no double beeps when activating a transmitter.

Check DIP switches #1 through 5 for correct house codes. Reposition switches to assure proper setting.

3. Transmitter gives poor signal strength when mounted on metal foil-backed wallpaper.

Move transmitter or space it away from wall with double-stick tape or Velcro.

4. LOW BAT is displayed at console when a fresh battery is installed.

Remove Battery from transmitter. Reshape terminals on battery and connector for tight fit. Replace battery and then enter Code plus OFF. Try another fresh battery if necessary.

5. Batteries must be replaced after a few weeks of operation.

Replace transmitter.

XI. GENERAL SPECIFICATIONS

ALERT III SYSTEM OPERATING FREQUENCY: UHF, 345 MHz (U.S. only)

No. 5720 RECEIVER/CONTROL

- Physical:**
- | | |
|---------|---------------|
| Width: | 8" (20.3 cm) |
| Height: | 15" (38.1 cm) |
| Depth: | 3" (7.6 cm) |
- Electrical:**
- Voltage:** 12 VAC (from No. 1324, 29 VA Plug-in Transformer).
- Wired Zone:** Normal Response: 250 msec
Fast Response (GREEN jumper cut): 10 msec
Max. permissible resistance (including 1000 ohm EOL resistor): 1300 ohms.
- Siren Driver Load:** 2A. max. at 6 VDC or 12 VDC.
- 6 VDC Regulated Output :** Continuous: 500 mA max. (incl. Pin 1 of Dialer Trigger Connector)
On Alarm: 2A max.
- 12 VDC Unregulated Output:** On Alarm: 2A max.
- Bell Relay (Dry) Contacts:** SPDT, Rating: 2A at 28 VDC
- Dialer Trigger Power Output:** Continuous: 500 mA max (incl. terminals 19/20)
On Alarm: 2A max.
- Dialer Trigger Outputs:** Normal: 0V
Activated: +6 VDC, 1 mA max.
- "Lights On" Output:** Compatible with X10 (BA284)* Burglary Alarm Interface, Nos. 4177* and 4148* Relays. Open circuit when not activated, 68 ohms to ground when activated.
*X10 (BA 284), 4177, and 4148 not UL Listed for household fire/burglary use with this system.
- Arm/Disarm Status Output:** Armed: 0V, Disarmed: +6 VDC, 5 mA max.
- Fuses:** Three 2 A Fuses (No. 90-2) for Dialer, Regulated 6 VDC output and Unregulated 12 VDC output.
- Standby:** 6 V Sealed Lead Acid Rechargeable Battery, 2.5 AH (No. 496) or 5 AH* (No. 498). Up to 10 hours with 2.5 AH battery and 20 hours with 5 AH battery (including one No. 5621 drawing 120 mA continuously). Additional accessories (e.g., second No. 5621 drawing 120 mA) will reduce standby time. Battery normally need not be replaced for at least 5 years.
- ** Note: The 5 AH (No. 498) battery is required for UL certificated installations.

No. 5621 SECURITY CONSOLE

- Physical:**
- | | |
|---------|-------------------|
| Width: | 6-1/2" (17.7 cm)* |
| Height: | 4-3/8" (11.1 cm) |
| Depth: | 1-3/8" (3.5 cm) |

*Requires additional 3" (7.6 cm) clearance at right, for opening of Transmitter Data Drawer.

Electrical:

Power: 120 mA at 6 VDC from No. 5720

No. 5727 PORTABLE REMOTE WIRELESS KEYPAD/TRANSMITTER

- Physical:**
- | | |
|---------|--------------------|
| Width: | 2-9/16" (6.5 cm) |
| Height: | 4-13/16" (12.2 cm) |
| Depth: | 15/16" (2.4 cm) |

Electrical:

Voltage: 9V Lithium battery (Ademco No. 465 or Kodak U9VL) can provide extended life of up to 5 years (5-year service not yet approved for UL installations). 9V Alkaline battery (Ademco No. 464, Eveready 522, or Duracell MN1604) may be used.

A "00" and "LOW BAT" will appear simultaneously in the event of a low battery in the Wireless Keypad.

Batteries should be changed at least annually*, or within 30 days after a "LOW BAT" indication (within 7 days if the keypad is used frequently every day.

* Within 5 years if using Lithium batteries in a non-UL Listed installation.

Range: 200 ft nominal (60m), indoor (the actual range is to be determined when the system is in the TEST mode).

Nos. 5711, 5711WM, 5715 (BURGLARY) TRANSMITTERS

Physical:

| | No. 5715 | No. 5711, 5711WM |
|---------|--------------------|-------------------------|
| Width: | 2-9/16" (6.5 cm) | 1-5/16" (3.3 cm) |
| Height: | 4-13/16" (12.2 cm) | 5-7/8" (14.9 cm) |
| Depth: | 15/16" (2.4 cm) | 1-1/2" (3.8 cm) |

Electrical:

Voltage: 9V Lithium battery (Ademco No. 465 or Kodak U9VL) can provide extended life of up to 5 years (5-year service not yet approved for UL installations). 9V Alkaline battery (Ademco No. 464, Eveready 522, or Duracell MN1604) may be used.

Batteries should be changed at least annually*, or within 30 days after a "LOW BAT" indication (within 7 days if the transmitter sees frequent daily activation).

* Within 5 years if using Lithium batteries in a non-UL Listed installation.

Loop: **5715:** 100 msec response for detection of an open (4 msec option available).
5711/5711WM: 500 msec response for detection of an open (10 msec option available).

Range: (All units).200 ft nominal (60m), indoor (the actual range is to be determined when the system is in the TEST mode).

No. 5775 PASSIVE INFRARED (BURGLARY) DETECTOR/TRANSMITTER

Physical:

| | |
|---------|-------------------|
| Width: | 3-1/16" (7.8 cm) |
| Height: | 3-13/16" (9.7 cm) |
| Depth: | 2-5/16" (5.9 cm) |

Protection

Pattern: 9 zones (84 degree span), coverage up to 35 feet (10m).

Electrical:

Voltage: 9V Lithium battery (Ademco No. 465 or Kodak U9VL) can provide extended life of up to 5 years (5-year service not yet approved for UL installations). 9V Alkaline battery (Ademco No. 464, Eveready 522, or Duracell MN1604) may be used. Batteries should be changed at least annually*, or within 30 days after a "LOW BAT" indication (within 7 days if the transmitter sees frequent daily activation).

* Within 5 years if using Lithium batteries in a non-UL Listed installation.

Range: 200 ft (60m) nominal, indoor (the actual range is to be determined when the system is in the TEST mode).

For additional information, see instructions accompanying the No. 5775.

No. 5706 SMOKE DETECTOR/TRANSMITTER

Physical: Diameter: 6-1/2" (15.9 cm)
Height: 1-1/16" (2.7 cm)

Electrical:

Voltage: 9V Lithium battery (Ademco No. 465 or Kodak U9VL) can provide extended life of up to 5 years (5-year service not yet approved for UL installations). 9V Alkaline battery (Ademco No. 464, Eveready 522, or Duracell MNI604) may be used.

Batteries should be changed at least annually*, or within 30 days after a "LOW BAT" indication (within 7 days if the transmitter sees frequent daily activation).

* Within 5 years if using Lithium batteries in a non-UL Listed installation.

Range: 200 ft (60m) nominal, indoor (the actual range is to be determined when the system is in the TEST mode).

For additional information, see instructions accompanying the No. 5706.

No. 5701 EMERGENCY (PANIC) TRANSMITTER

Physical: Width: 2-9/16" (6.5cm)
Height: 4-13/16" (12.2cm)
Thickness: 15/16" (2.4cm)

Electrical:

Voltage: 9V Lithium battery (Ademco No. 465 or Kodak U9VL) can provide extended life of up to 5 years (5-year service not yet approved for UL installations). 9V Alkaline battery (Ademco No. 464, Eveready 522, or Duracell MNI604) may be used.

Batteries should be changed at least annually*, or within 30 days after a "LOW BAT" indication (within 7 days if the transmitter sees frequent daily activation).

* Within 5 years if using Lithium batteries in a non-UL Listed installation.

Range: 200 ft. nominal (60m), indoor (the actual range is to be determined when the system is in the TEST mode).

"FEDERAL COMMUNICATIONS COMMISSION (FCC) STATEMENT"

This equipment has been tested to FCC requirements and has been found acceptable for use. The FCC requires the following statement for your information:

This equipment generates and uses radio frequency energy and if not installed and used properly, that is, in strict accordance with the manufacturer's instructions, may cause interference to radio and television reception. It has been type tested and found to comply with the limits for a Class B computing device in accordance with the specifications in Part 15 of FCC Rules, which are designed to provide reasonable protection against such interference in a residential installation. However, there is no guarantee that interference will not occur in a particular installation. If this equipment does cause interference to radio or television reception, which can be determined by turning the equipment off and on, the user is encouraged to try to correct the interference by one or more of the following measures:

- If using an indoor antenna, have a quality outdoor antenna installed.
- Reorient the receiving antenna until interference is reduced or eliminated.
- Move the receiver away from the control/communicator.
- Move the antenna leads away from any wire runs to the control/communicator.
- Plug the control/communicator into a different outlet so that it and the receiver are on different branch circuits.

If necessary, the user should consult the dealer or an experienced radio/television technician for additional suggestions. The user or installer may find the following booklet prepared by the Federal Communications Commission helpful:

"Interference Handbook"

This booklet is available from the U.S. Government Printing Office, Washington, DC 20402. Stock No. 004-000-00450-7.

FCC requires that the equipment shall not be modified or changed unless expressly authorized by the Installation Instructions or the User's Manual.

WARNING

THE LIMITATIONS OF THIS WIRELESS ALARM SYSTEM

While this System is an advanced wireless security system, it does not offer guaranteed protection against burglary, fire or other emergency. Any alarm system, whether commercial or residential, is subject to compromise or failure to warn for a variety of reasons. For example:

- Intruders may gain access through unprotected openings or have the technical sophistication to bypass an alarm sensor or disconnect an alarm warning device.
- Intrusion detectors (e.g., passive infrared detectors), smoke detectors, and many other sensing devices will not work without power. Battery-operated devices will not work without batteries, with dead batteries, or if the batteries are not put in properly. Devices powered solely by AC will not work if their AC power supply is cut off for any reason, however briefly.
- Signals sent by wireless transmitters may be blocked or reflected by metal before they reach the alarm receiver. Even if the signal path has been recently checked during a weekly test, blockage can occur if a metal object is moved into the path.
- A user may not be able to reach a panic or emergency button quickly enough.
- While smoke detectors have played a key role in reducing residential fire deaths in the United States, they may not activate or provide early warning for a variety of reasons in as many as 35% of all fires, according to data published by the Federal Emergency Management Agency. Some of the reasons smoke detectors used in conjunction with this System may not work are as follows. Smoke detectors may have been improperly installed and positioned. Smoke detectors may not sense fires that start where smoke cannot reach the detectors, such as in chimneys, in walls, or roofs, or on the other side of closed doors. Smoke detectors also may not sense a fire on another level of a residence or building. A second floor detector, for example, may not sense a first floor or basement fire. Finally, smoke detectors have sensing limitations. No smoke detector can sense every kind of fire every time. In general, detectors may not always warn about fires caused by carelessness and safety hazards like smoking in bed, violent explosions, escaping gas, improper storage of flammable materials, overloaded electrical circuits, children playing with matches, or arson. Depending on the nature of the fire and/or location of the smoke detectors, the detector, even if it operates as anticipated, may not provide sufficient warning to allow all occupants to escape in time to prevent injury or death.
- Alarm warning devices such as sirens, bells or horns may not alert people or wake up sleepers if they are located on the other side of closed or partly open doors. If warning devices are located on a different level of the residence from the bedrooms, then they are less likely to waken or alert people inside the bedrooms. Even persons who are awake may not hear the warning if the alarm is muffled by noise from a stereo, radio, air conditioner or other appliance, or by passing traffic. Finally, alarm warning devices, however loud, may not warn hearing-impaired people.
- Telephone lines needed to transmit alarm signals from a premises to a central monitoring station may be out of service or temporarily out of service. Telephone lines are also subject to compromise by sophisticated intruders.
- Even if the system responds to the emergency as intended, however, occupants may have insufficient time to protect themselves from the emergency situation. In the case of a monitored alarm system, authorities may not respond appropriately.
- This equipment, like other electrical devices, is subject to component failure. Even though this equipment is designed to last as long as 20 years, the electronic components could fail at any time.

The most common cause of an alarm system not functioning when an intrusion or fire occurs is inadequate maintenance. This alarm system should be tested weekly to make sure all sensors and transmitters are working properly. The security console (and remote keypad) should be tested as well.

Installing an alarm system may make the owner eligible for a lower insurance rate, but an alarm system is not a substitute for insurance. Homeowners, property owners and renters should continue to act prudently in protecting themselves and continue to insure their lives and property.

We continue to develop new and improved protection devices. Users of alarm systems owe it to themselves and their loved ones to learn about these developments.

**ADEMCO
LIMITED WARRANTY**

Alarm Device Manufacturing Company, a Division of Pittway Corporation, and its divisions, subsidiaries and affiliates ("Seller"), 165 Eileen Way, Syosset, New York 11791, warrants its products to be in conformance with its own plans and specifications and to be free from defects in materials and workmanship under normal use and service for 18 months from the date stamp control on the product or, for products not having an Ademco date stamp, for 12 months from date of original purchase unless the installation instructions or catalog sets forth a shorter period, in which case the shorter period shall apply. Seller's obligation shall be limited to repairing or replacing, at its option, free of charge for materials or labor, any part which is proved not in compliance with Seller's specifications or proves defective in materials or workmanship under normal use and service. Seller shall have no obligation under this Limited Warranty or otherwise if the product is altered or improperly repaired or serviced by anyone other than Ademco factory service. For warranty service, return product transportation prepaid, to Ademco Factory Service, 165 Eileen Way, Syosset, New York 11791

THERE ARE NO WARRANTIES, EXPRESS OR IMPLIED, OF MERCHANTABILITY, OR FITNESS FOR A PARTICULAR PURPOSE OR OTHERWISE, WHICH EXTEND BEYOND THE DESCRIPTION ON THE FACE HEREOF. IN NO CASE SHALL SELLER BE LIABLE TO ANYONE FOR ANY CONSEQUENTIAL OR INCIDENTAL DAMAGES FOR BREACH OF THIS OR ANY OTHER WARRANTY, EXPRESS OR IMPLIED, OR UPON ANY OTHER BASIS OF LIABILITY WHATSOEVER, EVEN IF THE LOSS OR DAMAGE IS CAUSED BY THE SELLER'S OWN NEGLIGENCE OR FAULT

Seller does not represent that its product may not be compromised or circumvented; that the product will prevent any personal injury or property loss by burglary, robbery, fire or otherwise; or that the product will in all cases provide adequate warning or protection. Buyer understands that a properly installed and maintained alarm may only reduce the risk of a burglary, robbery or fire without warning, but it is not insurance or a guarantee that such will not occur or that there will be no personal injury or property loss as a result. CONSEQUENTLY, SELLER SHALL HAVE NO LIABILITY FOR ANY PERSONAL INJURY, PROPERTY DAMAGE OR OTHER LOSS BASED ON A CLAIM THE PRODUCT FAILED TO GIVE WARNING. However, if Seller is held liable, whether directly or indirectly, for any loss or damage arising under this Limited Warranty or otherwise, regardless of cause or origin, Seller's maximum liability shall not in any case exceed the purchase price of the product, which shall be the complete and exclusive remedy against Seller.

This warranty replaces any previous warranties and is the only warranty made by Seller on this product. No increase or alteration, written or verbal, of the obligation of this Limited Warranty is authorized.

ADEMCO

N4471V2 2/90

ALARM DEVICE MANUFACTURING CO.
A DIVISION OF PITTMAY CORPORATION
165 Eileen Way, Syosset, New York 11791

Copyright © 1989 PITTMAY CORPORATION