

11 ZONE
SECURITY CONTROL/
COMMUNICATOR

Z1100

INSTALLATION,
PROGRAMMING
& OPERATION

moose

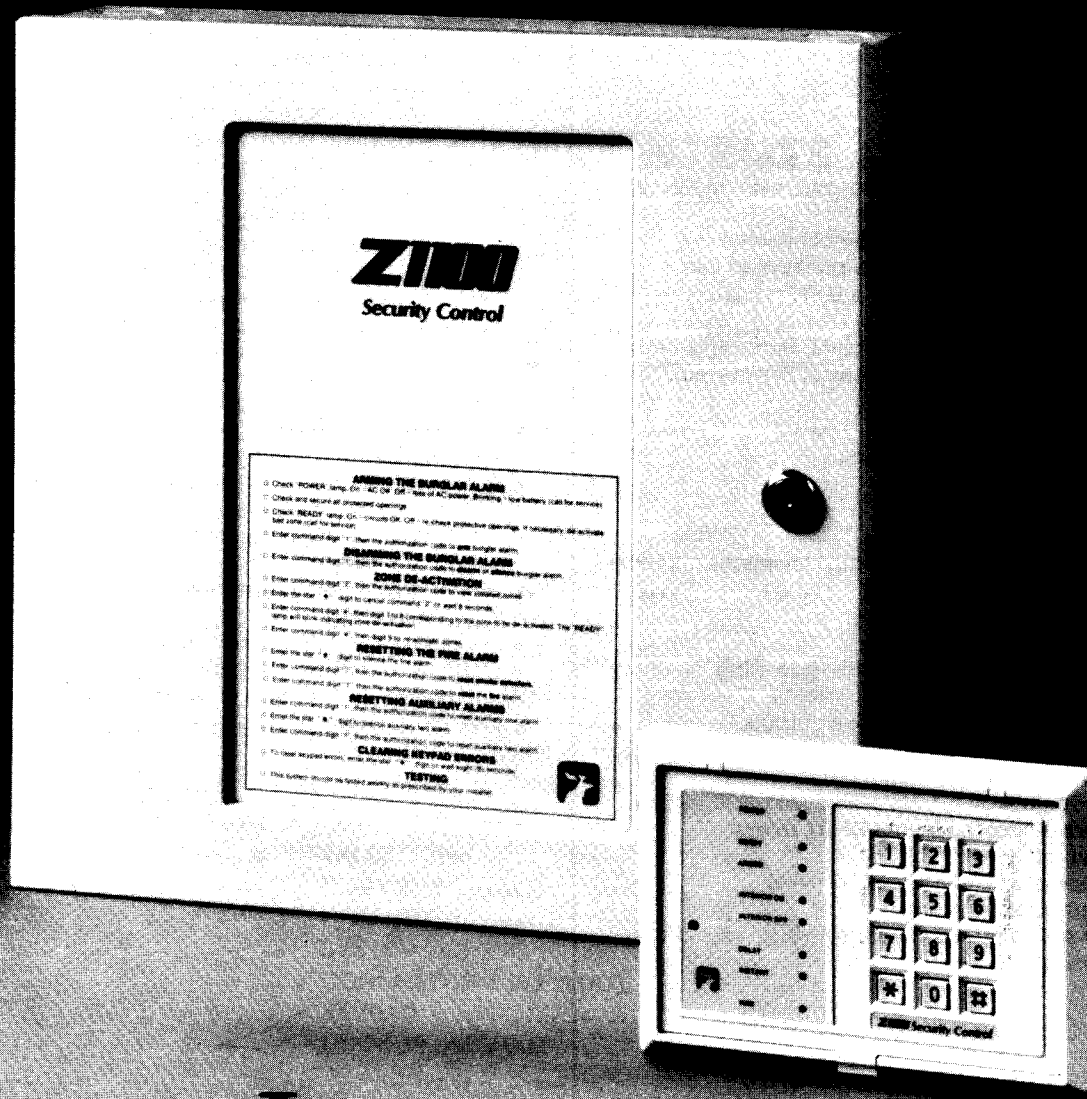

System I

APPLICATION

The Z1100 is a multi-zone, keypad programmable security control with a built-in digital communicator. It is equally suitable for commercial or residential installations.

SPECIFICATIONS

- Eight (8) 2-wire zones. Each zone is supervised with a 2200 ohm end-of-line resistor.
- Three (3) keypad-activated zones.
- Attractive remote keypad (Z1100R):
 - Flush or surface mountable.
 - 4-wire hookup.
 - Built-in pre-alarm.
 - Total system & zone status. (8 LEDs)
 - 12 button telephone type pad with tactile and audible feedback.
 - Up to seven remotes may be connected.
 - Current drain: 70 Milliamps per keypad idle.
 - Dimensions: 6.82" x 4.72" x 0.83"
- Digital communicator:
 - Transmits all major formats including Acron, Ademco, Franklin, Radionics, Sescoa, and Silent Knight.
 - DPDT Line Seizure.
 - Pulse or Touch-Tone dialing.
 - Anti-jam feature.
 - Hexidecimal reporting.
 - True dial-tone detection.
 - Can dial two (2) different 30 digit telephone numbers for reporting.
- Heavy-duty 1.5 amp power supply:
 - Regulated 13.8 volts DC.
 - 900 milliamps available for powering auxiliary devices.
 - Separate fused Fire & Smoke outputs.
 - Battery float-charge circuit.
- 18 VAC 35 VA UL-Listed transformer.
- 12 Volt, 6 AH or 12 Volt 5.4 AH sealed lead-acid battery.
- Two (2) general-purpose 5-amp SPDT relays.
- Metal cabinet: 14" x 14" x 3.5"
 - Key operated cabinet lock. (2 keys)
- Operating temperature range:
 - 32 to 122 degrees Fahrenheit (0 to +50 degrees Celsius).

FEATURES

- Comes factory ready with a basic program. No programming required to bench test.
- All functions keypad programmable: Four (4) user codes available. Shunt by zone.
- Zone options include burglar, fire, police, medical, day alert and key.
- All Burglar Zones have exit delay.
- Two entrance delay times available.
- Instant Zones are shunted during entrance delay. (follower feature)
- Memory of last alarm occurrence is retained until next alarm.
- Digital communicator:
 - Report by zone.
 - Expanded or single line reporting.
 - Open & Close reports by user code.
 - Exception opening report.
 - Restore reporting.
 - Cancel reporting.
 - Trouble reporting.
 - Low battery reporting.
 - Shunted-zone reporting.
 - Programmable delay before dialing.
 - 24 hour automatic test reporting.
 - Programmable dial attempts.
- Fail-safe arming.
- Lamp courtesy light output.
- Access (door strike) output.
- Dynamic 24-hour battery load test.
- Removable Plug-in control board.
- EEPROM (non-volatile) memory.
 - Will not lose programmed features during total loss of power.
- Restores to previous arm/disarm status after total loss of power.
- Watchdog microprocessor-monitoring.
- Optional Handheld Programmer for convenient loading and reviewing of programmed features. (Z1100P)
- Five Stage Lightning/Transient Protection.

INTRODUCTION

The Z1100 system represents the latest technological advances in the security electronics industry. The universal adaptability of the Z1100 satisfies the requirement for a high performance security system. It has been designed to minimize operator confusion through the use of a simple, yet powerful, Keypad Command Center.

The Z1100 utilizes a microprocessor design combining all control and communications electronics on a single printed circuit board. This type of design enables the Z1100 to deliver superior, competitive performance. All program options are stored in a NON-VOLATILE EEPROM (Electrically Erasable Programmable Read Only Memory), which maintains its data even with power disconnected. This EEPROM may be reprogrammed over and over for changing the system characteristics. The Z1100's microprocessor is constantly monitored by a "WATCHDOG TIMER", which maintains the operational integrity of the system.

The Z1100 Control/Communicator is easy to set up and use. We recommend that you read Sections 1 and 2 of this manual first, to get familiar with the system and its basic operation. The other sections of this manual provide a thorough explanation of the Z1100's many features.

TABLE OF CONTENTS

1. SYSTEM OVERVIEW	
INTRODUCTION	3
SPECIFICATIONS	2
DEFAULT SETTINGS	4
2. BENCH TESTING	
INITIAL SETUP	5
KEYPAD TESTING	6
3. PROGRAMMING	
USER LEVEL	9
CHANGING CODES	10
ADDRESS (INSTALLER) LEVEL	12
4. COMMUNICATOR	
OVERVIEWS & DEFAULT SETTINGS	15
TELEPHONE REQUIREMENTS	17
5. INSTALLATION	
PLANNING	18
HARDWARE	18
SYSTEM TESTING	19
CONNECTOR J-16 PINOUT	20
KEYPAD	21
HOOKUP DIAGRAM	22 & 23
6. APPENDICES	
MEMORY MAP	24-26
ZONE PLANNING GUIDE	27
QUICK TERMINAL REFERENCE	28
GLOSSARY	29
WARRANTY	29
FCC COMPLIANCE	30
Z1100R TEMPLATE	31

1. SYSTEM OVERVIEW

1.1 GENERAL

The Z1100 system is ready to use from the factory. It comes pre-programmed with factory basic (Default) settings of seven Burglar zones, one Fire zone, and three Keypad zones. The system can be reprogrammed from the keypad to meet a variety of needs. Each zone is individually programmable for Burglary, Fire, Police, Medical or Key. Separate timers are programmable for Alarm cutoffs, Entrance and Exit times (2 Entrance timers), Loop Response time and Access on time. The built-in Digital Communicator is programmable for most of the popular receiver formats.

The Z1100R 4 wire keypad "Commands" the system with a special COMMAND key followed by a USER AUTHORIZATION code. For example, COMMAND [] and 2-4-5 will Arm or Disarm the factory default system.

1.2 FACTORY DEFAULT SETTINGS AND OPTIONS SUMMARY

No special prom programmer is required to take advantage of this control's many features. Table 1-1 provides a list of the major features of the Z1100 system as it comes from the factory. If the default settings described below do not meet your installation requirements, they can all be easily changed from the keypad.

USER AUTHORIZATION code 1: 2-4-5	
USER AUTHORIZATION code 2: not active	
USER AUTHORIZATION code 3: not active	
USER AUTHORIZATION code 4: not active	
PROGRAM AUTHORIZATION code: 9-8-7-6-5	
ZONE 1: BURGLAR Delay 1 Perimeter	Slow loop response
ZONE 2: BURGLAR Delay 2 Perimeter	Slow loop response
ZONE 3: BURGLAR Instant Interior	Slow loop response
ZONE 4: BURGLAR Instant Perimeter	Slow loop response
ZONE 5: BURGLAR Instant Perimeter	Slow loop response
ZONE 6: BURGLAR Instant Perimeter	Slow loop response
ZONE 7: BURGLAR Instant Perimeter	Slow loop response
ZONE 8: FIRE	Slow loop response
EXIT time:	60 seconds
ENTRANCE time (Delay 1):	30 seconds
ENTRANCE time (Delay 2):	45 seconds
BURGLAR Alarm cutoff time:	15 minutes
FIRE Alarm cutoff time:	No cutoff
POLICE/AUX 1 Alarm cutoff time:	15 minutes
MEDICAL/AUX 2 Alarm cutoff time:	15 minutes
LOOP RESPONSE TIMES:	
Slow	= 320 milliseconds
Fast	= 80 milliseconds

Table 1-1: Basic Factory System Characteristics

1.3 PROGRAMMABLE ZONE OPTIONS

The Z1100 has eight (8) end-of-line resistor supervised zones. Each may be wired with a combination of normally open and normally closed devices. Multiple zones may be programmed for BURGLAR, FIRE, POLICE, and MEDICAL. Any one zone may be programmed as a momentary Key zone, but only one Key zone may exist per system. Sub options exist for each option except Key. The ZONE PLANNING GUIDE, APPENDIX B provides a table for assisting in zone planning. The zone options are given in Table 1-2.

ZONE TYPE	OPTION	SUB OPTION
BURGLAR	INSTANT	SLOW OR FAST LOOP RESPONSE
	ENTRANCE DELAY 1	ZONE LOCKOUT
	ENTRANCE DELAY 2	AFTER ALARM
	PERIMETER	DAY ALERT
	INTERIOR	
FIRE		SLOW OR FAST LOOP RESPONSE
POLICE		SLOW OR FAST LOOP RESPONSE
		SILENT OR AUDIBLE
MEDICAL		SLOW OR FAST LOOP RESPONSE
KEY (MOMENTARY ONLY)		

Table 1-2 Programmable Zone Options

1.4 KEYPAD ZONES

Three auxiliary zones may be activated from the keypad by pressing a combination of two (2) digits simultaneously and holding them down for one (1) second. When a combination is pressed and held, the system goes into alarm. The keypad begins beeping and an LED lights to annunciate the type of alarm activated. The Digital Communicator may be programmed to transmit a separate code for each alarm type. The combinations are:

Keys 1 and 7 for FIRE

Keys 3 and 9 for MEDICAL/AUX 2.

Keys * and # or 1 and 3 for POLICE/AUX 1.

(POLICE/AUX 1 may be programmed for totally silent operation.)

1.5 TIMER OPTIONS

The following are the Programmable Timer Options.

- | | |
|-------------------------|---------------------------------------|
| 1. Burglar Alarm Cutoff | 1 minute to 255 minutes or no cutoff. |
| 2. Police Alarm Cutoff | 1 minute to 255 minutes or no cutoff. |
| 3. Fire Alarm Cutoff | 1 minute to 255 minutes or no cutoff. |
| 4. Medical Alarm Cutoff | 1 minute to 255 minutes or no cutoff. |
| 5. Exit Time | 1 second to 255 seconds.* |
| 6. Entrance Delay 1 | 1 second to 255 seconds.* |
| 7. Entrance Delay 2 | 1 second to 255 seconds.* |
| 8. Slow Loop Response | 40 milliseconds to 10.2 seconds.* |
| 9. Fast Loop Response | 40 milliseconds to 10.2 seconds.* |
| 10. Access on Time | 1 second to 255 seconds.* |

*CAUTION: DO NOT PROGRAM "000" for these values. Improper operation will result. Example: Exit time will never run out if set as "000".

1.6 USER AUTHORIZATION CODES

There are four independent USER AUTHORIZATION codes which may be programmed. Each code can be from 1 to 5 digits in length and may be assigned a specific level of

security. The system allows the option of single, 2 digit, or full code arming with the full code required for disarming. One code, (USER 4) may be programmed for a limited number of usages. Following are the programmable levels of security:

1. ARM and DISARM.
2. ACCESS ONLY. (Activate a door strike using COMMAND 0.)
3. ARM and DISARM or ACCESS.
5. ARM and DISARM and ACCESS. ACCESS will activate simultaneously each time the system is ARMED or DISARMED.
7. ARM and DISARM and ACCESS or ACCESS ONLY using Command 0.
9. DURESS. (Ambush) Activates keypad POLICE when ARMED/DISARMED.

1.7 ACCESSORIES

1. Z1100P hand held programmer. The programmer Uploads/Downloads system parameters from control to programmer. This unit features an easy to read LCD screen, rugged travel case and all necessary hardware.
2. Z1100R keypad. Up to 7 keypads may be used with each system.

2. BENCH TESTING

2.1 INITIAL SET-UP AND BENCH TEST

The following paragraphs provide a method for becoming familiar with the Z1100 prior to understanding all of its capabilities and detailed operational characteristics. This test series assumes one has nothing more than a Z1100 system, a screwdriver and some wire to connect the transformer. These steps will take one through hook-up, operation and limited programming of the system.

2.2 UNPACK THE Z1100

Inspect the carton for the following contents.

1. Specifications & Instructions manual.
2. Z1100 Metal Box with cabinet lock and two keys.
3. Right and left terminal boards mounted in the metal box.
4. Z1100 Control Board with J-16 wiring harness.

Complete systems also contain:

5. 18 Volt 35VA transformer.
6. 12 Volt 6AH sealed lead acid battery.
7. Z1100R Keypad with wiring harness.

If any of these items are missing or damaged, notify your security electronics distributor immediately.

2.3 START UP PROCEDURE

The following is the start up procedure for the Z1100 system. Default authorization codes are used for examples. Refer to Figure 5-1 for a detailed hookup diagram of the Z1100.

1. Make the following initial connections.
 1. Connect a 2200 Ohm end-of-line resistor across each zone.
 2. Connect the Z1100R Keypad.
 3. Plug in the Z1100 Control Board. (See Section 5.)
 4. Connect the transformer and battery.
2. Turn Power Switch ON. The AC LED should be ON. If AC LED does not light, check the transformer and the AC power receptacle.

NOTE: If the keypad beeps four times, the Program Switch is closed and the system is in the Program Mode. STOP. Turn Power Switch OFF. Open the Program Switch. Return to step 2.

CAUTION: Always turn the Power Switch OFF before opening or closing the Program Switch.

3. Four LEDs should now be ON.

POWER AC power

READY Zone status

INTERIOR ON Interior zones on

DELAY Entrance delay time in effect

If the READY LED is not illuminated, a zone is violated. Refer to KEYPAD TESTING (2.4.1) for displaying zone status.

2.4 KEYPAD

The Z1100R keypad is more than an arming station, it's a "Command Center." Eight multi-function LEDs indicate system status, zone status, alarm memory, alarm activations, and also provide a "window" into the more advanced features of the system. A door on the keypad lifts up to reveal an inside label. This label provides a space for marking each zone description and also lists the various Commands and LED functions.

The Keypad commands the system to ARM, disarm, display zone STATUS, display ALARM MEMORY, turn INTERIOR zones ON or OFF, switch to DELAY or INSTANT mode, activate day MONITOR, reset SMOKE power and test BATTERY, activate loop TEST, enter PROGRAM mode, RESET, activate ACCESS, and SHUNT (bypass) zones. The Z1100R Keypad requires only four wires to take advantage of its many features. Up to 7 keypads may be connected in parallel to the system. See Figures 5-1 and 5-2 for hookup diagrams.

2.4.1 KEYPAD TESTING

A thorough understanding of the keypad is necessary for successful operation of the system. The following COMMAND examples use the factory default USER AUTHORIZATION code. See Section 3.2 for information regarding changing the USER AUTHORIZATION codes. Only Commands 1 and 0 will work while the burglar system is armed.

COMMAND FORMAT: Press a Command key followed by a USER AUTHORIZATION code. For example, to "Command" the Z1100 system to display ZONE STATUS, enter **2** -2-4-5.

COMMAND 1: ARM/DISARM. Use this command to ARM/DISARM Burglar zones or to acknowledge (reset) Fire, Police, or Medical alarms.

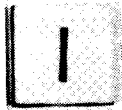

FORMAT: **1** - USER AUTHORIZATION code.

ARM: Enter **1** -2-4-5.

DISARM: Enter **1** -2-4-5.

COMMAND 2: Display ZONE STATUS. This command may be used to check the status of zones.



Lighted LEDs indicate zone(s) violated (not secure).

Blinking LEDs indicate zone(s) shunted.

Dark LEDs indicate zone(s) normal (secure).

This command latches for 8 seconds. The latch time can be extended by pressing any key, except the ***** key.

FORMAT: **2** - USER AUTHORIZATION code.

Display ZONE STATUS: Enter **2** -2-4-5.

COMMAND 3: Display ALARM MEMORY. Use this command to determine which hardwire zone(s) caused the most recent alarm. Lighted LEDs indicate zone(s) that caused most recent alarm.



This command latches for 8 seconds. The latch time can be extended by pressing any key, except the ***** key.

FORMAT: **3** - USER AUTHORIZATION code.

Display ALARM MEMORY: Enter **3** -2-4-5.

COMMAND 4: Turn INTERIOR zones ON or OFF. Any zone defined as Interior may be turned OFF (shunted) prior to arming by using this Command.



FORMAT: **4** - USER AUTHORIZATION code.

INTERIOR OFF: Enter **4** -2-4-5.

INTERIOR ON: Enter **4** -2-4-5.

NOTE: The INTERIOR and the DELAY/INSTANT modes both revert back to default (INTERIOR ON and DELAY active) when the system is disarmed. The default setting for these two modes may be modified by programming a value into ADDRESS 040. This is explained in Address Programming section 3.3.

COMMAND 5: DELAY or INSTANT. Use this command to switch between DELAY and INSTANT modes before arming. "INSTANT" means no entrance delay time for any burglar delay zone. "DELAY" means delay zones have entrance delay time. All burglar zones have exit delay regardless of mode.



FORMAT: **5** - USER AUTHORIZATION code.

INSTANT: Enter **5** -2-4-5.

DELAY: Enter **5** -2-4-5.

COMMAND 6: Day MONITOR. Use this command to turn the day MONITOR mode on or off. When the day MONITOR mode is on, the keypad will beep three times each time any burglar zone is violated. Day MONITOR is for use while the system is disarmed. Shunted zones will not annunciate.



FORMAT: **6** USER AUTHORIZATION code.

MONITOR ON: Enter **6** -2-4-5. 3 beeps.

MONITOR OFF: Enter **6** -2-4-5. 2 beeps.

COMMAND 7: SMOKE reset and BATTERY load test. Use this command to reset smoke power and manually load test the system battery. Smoke power output is reset during manual or automatic battery test. **DO NOT** power BURGLAR sensors from smoke power output terminal. See Section 2.7 and 2.8 for further information.



FORMAT: **7** - USER AUTHORIZATION code.

SMOKE reset/BATTERY test: Enter **7** -2-4-5.

COMMAND 8: TEST mode. The TEST mode provides a means for walk testing burglar loops. When TEST is activated, the keypad beeps continuously when any burglar zone is violated.



FORMAT: **8** - USER AUTHORIZATION code.

TEST mode ON: Enter **8** -2-4-5.

TEST mode OFF: Enter *****

NOTE: While in the test mode command 2, if activated, will latch for as long as any zone is violated.

COMMAND 9: PROGRAM. See Section 3.2 for further information.



FORMAT: **9** - PROGRAM AUTHORIZATION code.

PROGRAM mode: Enter **9** 9-8-7-6-5.

COMMAND 0: ACCESS. Use this command followed by an access defined USER AUTHORIZATION code to activate a door release device. Connector J-16 provides an output lead for ACCESS. See Figure 5-1.



FORMAT: **0** - USER AUTHORIZATION code.

COMMAND *: RESET. The ***** key may be used to clear keypad entries, silence the keypad, acknowledge Fire and Medical/Aux 2 alarms, jump out of some commands, or jump out of the programming mode.

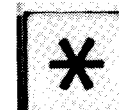

COMMAND #: SHUNT. Any burglar zone may be shunted (bypassed). The READY LED blinks when a zone is shunted. COMMAND 2 will display which zone is shunted by blinking the corresponding LED.



FORMAT: **#** - number of the zone to be shunted.

To shunt zone 3 press **#** and then press 3. To remove all shunts press **#** then press 9.

NOTE: All shunts are removed when the system is disarmed **after** the exit delay time has expired.

2.4.2 KEYPAD TIME RESTRICTIONS

There are two timers to prevent tampering or accidental changing of the programmed data base within the Z1100. One is an 8 second timer and the other is a 3 minute timer.

8 SECOND TIMER.

The purpose of the 8 second timer is to automatically reset the keypad 8 seconds after a partial or improper key series is entered. The 8 second timer restarts each time a key is pressed. A two second error tone will sound and the keypad will reset whenever the 8 second timer runs out. If an improper digit is entered, the Z1100 will ignore the entry and all further entries, even a proper sequence, until the keypad is reset manually with the **[*]** key or automatically by the 8 second timer.

3 MINUTE TIMER.

The purpose of the 3 minute timer is to take the system out of the programming mode automatically 3 minutes after programming has ceased. The system allows 3 minutes between program steps and 8 seconds between value entries within a step. The system returns to the normal running mode when either time cycle runs out.

2.4.3 KEYPAD ZONES

The Z1100R keypad has three 24 hour keypad zones. FIRE, POLICE/AUX 1, and MEDICAL/AUX 2. The keypad zones are independent of the "hardwire" zones and can be activated at any time. It is not necessary for the system to be armed.

NOTE: Each keypad zone requires at least a 1 second closure in order to trip the system.

2.4.3.1 Keypad FIRE

1. Press keys 1 and 7 at the same time. Hold keys for one second.
2. The keypad will beep rapidly.
3. FIRE alarm output will activate.
4. FIRE LED will be on.
5. Press the **[*]** key to silence audible devices.
6. Audible devices silent. FIRE LED still on.
7. Reset FIRE alarm with command 1 and a USER AUTHORIZATION code. Enter **[*]** -2-4-5.
8. FIRE LED will be off.

2.4.3.2 Keypad POLICE/AUX 1

1. Press keys 1 and 3 or **[*]** and **[#]** together. Hold for 1 second.
2. The keypad will beep rapidly.
NOTE: Keypad POLICE may be programmed for silent operation. (see Section 3)
3. POLICE/AUX 1 alarm output will activate.
4. POLICE/AUX 1 LED (INTERIOR OFF LED) will blink.
5. Press the **[*]** key to silence keypad.
6. Reset POLICE/AUX 1 alarm with command 1 and a USER AUTHORIZATION code. Enter **[*]** -2-4-5.
7. POLICE/AUX 1 LED (INTERIOR OFF LED) off and audibles silent.

2.4.3.3 Keypad MEDICAL/AUX 2

1. Press keys 3 and 9 together. Hold for 1 second and **release**.
2. The keypad will beep slowly.
3. MEDICAL/AUX 2 alarm output will activate.
4. MEDICAL/AUX 2 LED (INSTANT LED) will blink.
5. Press the **[*]** key to silence audible devices.
6. Reset MEDICAL/AUX 2 alarm with command 1 and a USER AUTHORIZATION code. Enter **[*]** -2-4-5.
7. MEDICAL/AUX 2 LED (INSTANT LED) will be off.

2.5 TESTING BURGLAR ZONES

Use the following procedure to test each zone and to become familiar with the performance of the Z1100 system.

1. Violate zone 1. Short across the 2200 Ohm end-of-line resistor or remove it.
2. The READY LED will be off.
3. Try to arm the system with the factory USER AUTHORIZATION code. Enter **[*]** -2-4-5.
NOTE: If you make a mistake while pressing keypad digits, just press the **[*]** key and start over.
4. The keypad will emit a 2 second error tone indicating that the system is not ready to be armed. Zone 1 is not secure.
5. Identify the violated zone(s). Enter **[*]** -2-4-5.
6. LED 1 will be on, indicating that Zone 1 is not secure.
The zone status display latches for eight (8) seconds.
7. Shunt the violated zone. Enter **[*]** -1.
8. The READY LED will begin blinking. A blinking READY LED indicates that a zone is shunted.
9. Arm the system. Enter **[*]** -2-4-5.
10. The ARMED LED will be on and the READY LED will be blinking.
11. The keypad will beep until the exit time expires (60 seconds). Wait for the exit time to expire.
NOTE: All shunted zones are restored (shunts removed) when the system is disarmed **after** the exit delay time expires.
12. Violate zone 3. Short across the 2200 Ohm end-of-line resistor or remove it.
13. The keypad will beep rapidly and the ARMED LED will blink indicating ALARM MEMORY.
NOTE: If the digital communicator is enabled, ARMED LED will not blink until the communicator receives a kissoff signal.
14. Press the **[*]** key to silence the keypad(Only).
15. The ARMED LED and the READY LED will be blinking.
16. Disarm the system. Enter **[*]** -2-4-5.
17. The ARMED LED will be blinking and the READY LED will be off. All shunts are removed when the system is disarmed.
18. Clear the blinking ALARM MEMORY LED with the **[*]** key.
19. Which zone caused the alarm? Use command 3 to check. Enter **[*]** -2-4-5. LED 3 is ON. Zone 3 caused the alarm. The alarm memory display latches for eight (8) seconds.
NOTE: The contents of ALARM MEMORY display is retained until another alarm occurs or the micro-processor resets.
20. Which zone(s) are violated? Use command 2 to check. Enter **[*]** -2-4-5. LEDs 1 and 3 will be on, indicating they are violated. The zone status display latches for eight (8) seconds.
21. Restore violated zones.
22. READY LED will be on.
23. Use the above procedure to test other burglar zones.

2.6 TESTING FIRE ZONES

FIRE zones, when programmed, are 24 hour zones. If the circuit opens, a TROUBLE signal is generated. If the circuit shorts, a FIRE alarm is sounded. Test a FIRE zone (zone 8) as follows.

2.6.1 FIRE TROUBLE

1. Open either side of the FIRE zone.
2. The keypad will beep rapidly.
3. FIRE LED will blink. Fire trouble indication.
4. Press the **[M]** key to silence keypad.
5. FIRE LED still blinking.
6. Restore FIRE zone to normal condition.
7. FIRE LED will be off.

2.6.2 FIRE ALARM

1. Connect a smoke detector or fire sensor (see Figure 5-1).
2. Violate the fire sensor or short across the loop.
3. The keypad will beep rapidly.
4. FIRE alarm output will activate.
5. FIRE LED will be on. Fire alarm indication.
6. Press the **[M]** key to silence audible devices.
7. FIRE LED still on.
8. Reset FIRE alarm with command 1 and a USER AUTHORIZATION code. Enter **[*]** -2-4-5.
9. The FIRE LED will blink if detectors are latched or if the loop is still shorted. Remove all shorts.
10. To reset latched detectors, reset SMOKE power with command 7 and a USER AUTHORIZATION code. Enter **[*]** -2-4-5.
11. FIRE LED will be off. See Section 2.7 if the POWER LED is blinking.

2.7 AUTOMATIC BATTERY LOAD TEST AND SMOKE POWER RESET

The system battery is automatically load tested every 24 hours. If the Z1100 microprocessor detects a weak battery, the POWER LED blinks and the keypad beeps. Silence the keypad with the **[M]** key. The POWER LED will continue to blink until a fully charged battery is detected either during the next 24 hour load test, or during a manual test.

When the system load tests the battery, power will be removed from all devices that are connected to the SMOKE power output. **DO NOT** power BURGLAR detection sensors from the SMOKE power output terminal 31. If a burglar detection sensor is powered from this output and an automatic test occurs while the system is armed, false alarms may occur. Fire defined zones are designed to compensate for this test.

2.8 MANUAL BATTERY TEST AND SMOKE POWER RESET

The battery may be manually tested while the system is disarmed. Enter command 7 followed by a USER AUTHORIZATION code. **[*]** -2-4-5. This command also removes power from the SMOKE power output (terminal 31) for 5 seconds. Use the following procedure to simulate a battery test with a weak battery.

1. Disconnect one leg of the battery or connect a weak battery.
2. Enter command 7 followed by a USER AUTHORIZATION code. Enter **[*]** -2-4-5.
3. The keypad will beep rapidly.
4. POWER LED on keypad will blink.
5. Press the **[M]** key to silence keypad.
6. POWER LED still blinking.
7. Re-connect good battery.
8. Enter command 7 followed by a USER AUTHORIZATION code. Enter **[*]** -2-4-5.
9. POWER LED stops blinking.

2.9 POLICE/AUX 1, MEDICAL/AUX 2, AND KEYSWITCH DEFINED ZONES

Use the following steps to program and test the Z1100 with remote police and medical sensors and test arming/disarming using a momentary keyswitch. The steps will define zone 4 a police zone, zone 5 a medical zone, and zone 6 a key zone.

1. Remove system power by turning the Power Switch off.
2. Close the Program Switch. This switch is located on the Z1100 control. See Figure 5-1.
3. Restore system power by turning the Power Switch on. System will power up in the programming mode.
4. Enter **[*]** (ADDRESS PROGRAMMING mode).
5. Enter 0-2-5 (Zone 4 definition address).
6. Enter 0-0-3 (Defines zone 4 as POLICE).
7. Enter **[#]** (steps to next address).
8. Enter 0-0-4 (Defines zone 5 as MEDICAL).
9. Enter **[#]** (steps to next address).
10. Enter 0-0-5 (Defines zone 6 as KEY).
11. Enter **[*]** (terminates program mode).

2.9.1 TESTING ZONE 4 AS A POLICE/AUX 1 ZONE

1. Violate Zone 4.
2. The keypad will beep rapidly.
NOTE: See Section 3 for programming police as silent.
3. POLICE/AUX 1 alarm output will activate.
4. POLICE LED (INTERIOR OFF LED) will blink.
5. Reset AUX 1/POLICE alarm with command 1 and a USER AUTHORIZATION code. Enter **[*]** -2-4-5.
6. POLICE/AUX 1 LED will be off.

2.9.2 TESTING ZONE 5 AS A MEDICAL/AUX 2 ZONE

1. Violate zone 5.
2. The keypad will beep slowly.
3. MEDICAL/AUX 2 alarm output will activate.
4. MEDICAL LED (INSTANT LED) will blink.
5. Press the **[M]** key to silence audible devices.
6. Reset AUX 2/MEDICAL alarm with command 1 and a USER AUTHORIZATION code. Enter **[*]** -2-4-5.
7. MEDICAL/AUX 2 LED will be off.

2.9.3 TESTING ZONE 6 AS A KEY ZONE

A momentary keyswitch may be either parallel or series connected to one (1) of the end-of-line resistor supervised zones. This zone, when programmed, will arm and disarm the Z1100 each time the zone is opened or shorted and then restored.

1. Short across the 2200 Ohm end-of-line resistor on zone 6 for approximately one (1) second and then remove the short.
2. The ARMED LED will be on. System armed.
3. The keypad will beep until the exit time expires if the exit time is programmed with an even number. ie 2, 4, 6, etc.
4. Short across zone 6 for approximately one (1) second and then remove the short.
5. The ARMED LED will be off. System disarmed.
NOTE: Connector J-16 provides a circuit status and armed output for remoting these LEDs to keyswitch stations.

2.9.4 CHANGING THE USER AUTHORIZATION CODE

The following procedure will change the USER AUTHORIZATION code 1 to 7-8-9.

1. Enter -9-8-7-6-5 (PROGRAM AUTHORIZATION code).
2. Enter (USER PROGRAMMING Option 1).
3. Enter 1-7-8-9-0-0. The configuration digit "1" and the trailing zeros are explained in Section 3.2.4.
4. Keypad automatically returns to normal operating mode. Before going to next step, verify that the READY LED is on.
5. Arm the system with command 1 and the new USER AUTHORIZATION code. Enter -7-8-9.
6. The ARMED LED will be on. System armed.
7. Disarm the system with command 1 and the new USER AUTHORIZATION code. Enter -7-8-9.

2.9.5 RESTORE THE Z1100 TO FACTORY DEFAULT PROGRAM

Section 2.9 provided a quick introduction to ADDRESS PROGRAMMING and zone modification. For a thorough

explanation of the ADDRESS PROGRAMMING method, see Section 3.3.

Use the following procedure to return the Z1100 system to its default (factory programmed) settings.

1. Remove system power by turning the Power Switch off.
2. Close the Program Switch. This switch is located on the Z1100 control. See Figure 5-1.
3. Restore system power by turning the Power Switch on. System will power up in the programming mode.
4. Enter 0 (ADDRESS PROGRAMMING Mode).
5. Enter 0-0-9 (factory bootstrap address).
NOTE: No LEDs should be ON. If any LEDs are ON, press to exit, then turn the Power Switch Off then back ON and return to step 2.
6. Enter 2-5-5. All LEDs should now be on.
7. Enter to terminate programming mode.
8. Turn the Power Switch off.
9. Open the Program Switch.
10. Turn the Power Switch on.
11. System is now returned to default settings.

3. PROGRAMMING

3.1 OVERVIEW

Programming is the principal means one uses to communicate with a computer based system. The program enables one to tell the system what to do and how to do it. The Z1100 system offers two different levels of programming, USER and ADDRESS. Each programming level has a different purpose. One level is for the end user (USER level), and the other level is for the installer (ADDRESS level). The end user is not required to do any type of programming to use the system, but does have the option of changing arm/disarm codes and other limited features.

3.2 USER PROGRAMMING

The purpose of USER PROGRAMMING is to set USER AUTHORIZATION codes, the PROGRAM AUTHORIZATION code, as well as for changing ENTRANCE DELAY times and the COMMUNICATOR AUTOMATIC TEST time. This restricted level of programming can be used only for these features and prevents the end user from accidentally altering the system configuration.

3.2.1 USER PROGRAMMING FORMAT

All user programming is accomplished using the following 3 step format.

PROGRAM CODE + USER OPTION + VALUE

Each of these steps are explained in the remainder of this section.

3.2.2 PROGRAM CODE

The PROGRAM code consists of the command digit 9 followed by the PROGRAM AUTHORIZATION code -9-8-7-6-5. Entering the PROGRAM code places the Z1100 into the USER PROGRAMMING Mode. The default PROGRAM AUTHORIZATION code (9-8-7-6-5) can be changed. Once this code is changed the default code will no longer work.

3.2.3 USER OPTION

User option selects the function to be programmed. There are a total of 9 functions which may be programmed by the end user. These functions include four (4) USER AUTHORIZATION codes, the PROGRAM AUTHORIZATION code, USER CODE 4 USAGE COUNT, the COMMUNICATOR TEST TIME, ENTRANCE DELAY 1 and, ENTRANCE DELAY 2. (See Table 3-1)

3.2.4 VALUE

The user will program two different types of values into the Z1100. These values are either six (6) digits or three (3) digits in length. The six digit values are associated with the AUTHORIZATION codes and consist of a CONFIGURATION digit PLUS a five digit AUTHORIZATION code. The three digit value is associated with the USER AUTHORIZATION code 4 USAGE count and the various time settings. If the value is less than six or three digits, then leading or trailing zeros must be inserted to complete the required six or three digit value. The method of determining values will be explained under the individual programming paragraphs. The CONFIGURATION digits and their meaning are given in Table 3-2.

OPTION	DESCRIPTION	FORMAT/RANGE	VALUE
1	USER AUTHORIZATION CODE 1	CONFIGURATION # PLUS 5 DIGITS	— — — — —
2	USER AUTHORIZATION CODE 2	CONFIGURATION # PLUS 5 DIGITS	— — — — —
3	USER AUTHORIZATION CODE 3	CONFIGURATION # PLUS 5 DIGITS	— — — — —
4	USER AUTHORIZATION CODE 4	CONFIGURATION # PLUS 5 DIGITS	— — — — —
5	PROGRAM AUTHORIZATION CODE	CONFIGURATION 9 PLUS 5 DIGITS	9 — — — —
6	CODE 4 TEMPORARY USAGE	000-254 USAGE 255 = PERMANENT	— — —
7	COMMUNICATOR/BATTERY TEST OFFSET TIME	000-024 HOURS ADVANCE UNTIL FIRST TEST	0 — —
8	ENTRANCE DELAY TIME 1	001-255 SECONDS	— — —
9	ENTRANCE DELAY TIME 2	001-255 SECONDS	— — —

TABLE 3-1 USER PROGRAMMING GUIDE

CONFIGURATION DIGIT	SECURITY LEVEL
1	ARM and DISARM.
2	ACCESS ONLY. (COMMAND 0)
3	ARM and DISARM or ACCESS.
5	ARM and DISARM and ACCESS. ACCESS activates simultaneously each time the system is ARMED or DISARMED.
7	ARM and DISARM and ACCESS or ACCESS ONLY using Command 0.
9	DURESS. Any USER AUTHORIZATION code programmed with this CONFIGURATION digit activates keypad POLICE when ARMING and DISARMING.

TABLE 3-2 USER CONFIGURATION DIGIT

3.2.4.1 USER AUTHORIZATION CODE VALUE (options 1 thru 4)

Up to four independent USER AUTHORIZATION codes may be programmed. These codes consist of a CONFIGURATION digit plus a five (5) digit AUTHORIZATION code. The CONFIGURATION digit allows the user to assign a different level of security for each code; i.e., Arm/Disarm, Access (activate a door strike), or Duress. (See Table 3-2) Trailing zeros must be entered if a code of less than five (5) digits is desired.

CONFIGURATION DIGIT + FIVE (5) DIGIT AUTHORIZATION CODE

3.2.4.2 PROGRAM AUTHORIZATION CODE VALUE (option 5)

The system may have one PROGRAM AUTHORIZATION code. Like the USER AUTHORIZATION codes, this code consists of a CONFIGURATION digit (always 9) plus a five (5) digit AUTHORIZATION code. One should always use five (5) digits in the PROGRAM AUTHORIZATION code for better security although shorter codes may actually be entered by the use of trailing zeros (0).

9 + FIVE (5) DIGIT AUTHORIZATION CODE

3.2.4.3 CODE 4 TEMPORARY USAGE VALUE (option 6)

USER AUTHORIZATION code 4 is a special code which may be programmed to always function like codes 1 thru 3 or may be restricted to a given number of uses. For example, a workman could be given USER AUTHORIZATION code 4 with a TEMPORARY USAGE value of 002 which would allow disarming the security system in order to make repairs and rearming when departing. USAGE VALUE is reduced by 1 each time the code is used. Since a USAGE VALUE of 2 was programmed, the workman could not return at a later date and disarm the system.

Value may be from 001 to 254 uses. For permanent use enter 255.

3.2.4.4 COMMUNICATOR/BATTERY TEST TIME OFFSET VALUE (option 7)

The Z1100 has an automatic 24 hour test feature which is used to transmit a test signal from the digital communicator, if programmed, to a central monitoring station. This feature also performs a load test on the system battery. Central stations normally want test signals sent in the early morning hours when the work load is light. Option 7 allows one to offset the time this test will occur in whole hours from the present time until the desired time. Once set, a test will occur once a day (every 24 hours) at this time. Example: It is 4 pm and the test is to be at 3 am. Enter a value of 011 (4 pm to 3 am = 11 hours) into option 7.

Value may be 000 to 024 hours.

3.2.4.5 ENTRANCE DELAY 1 AND 2 VALUE (option 8 and 9)

ENTRANCE DELAY allows time to enter through a delay defined zone and disarm the system without tripping the alarm. All the burglar zones automatically convert to delay (follower feature) provided first point of entry is through a delay assigned zone.

The Z1100 system has two (2) ENTRANCE time values. Either Delay 1 or Delay 2 value may be assigned to delay zones. Values are in seconds.

To program ENTRANCE DELAY 1 for 30 seconds enter 030 into option 8.

To program ENTRANCE DELAY 2 for 2 minutes enter 120 into option 9.

Value may be 001 to 255 seconds.

CAUTION: "000" must not be programmed into options 8 or 9. "000" does not mean zero entry time. "000" means infinite entry time to the system.

3.2.5 USER PROGRAMMING METHODS

The method of entering USER PROGRAMMING is given in the following steps. The Z1100 Keypad will beep to prompt after each step.

1. Enter command 9 plus PROGRAM AUTHORIZATION code. 9 9-8-7-6-5
4 beeps
2. Select and enter user option number 1 thru 9. (See Table 3-1)
3 beeps
3. Select a value. (See Table 3-2)

The value selected must be either 3 or 6 digits. Use leading or trailing zeros to complete the 3 or 6 digit value. Trailing zeros must be entered but are not part of the authorization codes.

3 digit value	6 digit value
30 is entered as 030	1985 is entered as 198500
8 is entered as 008	321 is entered as 321000
205 is entered as 205	11023 is entered as 110230

4. Enter selected value. 3 beeps

The Z1100 returns automatically to the regular running mode. To enter additional user options, return to step 1. If a mistake is made while programming with the keypad, press the **⏏** key until the keypad either beeps three times or emits a 2 second error tone, then start over.

CAUTION: Once value entry is started, the full sequence must be completed. Pressing the **⏏** key or failing to complete the value entry will result in ZEROS being automatically placed into that memory location. If this happens, erroneous operation may occur. To correct this condition, start over by reprogramming that option.

3.2.6 USER PROGRAMMING EXAMPLES

The following are typical examples of user programming.

3.2.6.1 USER AUTHORIZATION CODE EXAMPLES

USER AUTHORIZATION code 1 will be an ARM and DISARM code. USER AUTHORIZATION code 3 will be an ACCESS only code which may be used to activate a door strike but not ARM and DISARM the system.

Program the ARM/DISARM code as 3-3-6-8.

Program the ACCESS ONLY code as 8-9-7-6.

1. Enter **9** 9-8-7-6-5 (default PROGRAM AUTHORIZATION code).
2. Enter 1 for USER AUTHORIZATION Option 1. (See Table 3-1).
3. Enter 1 for CONFIGURATION digit 1. (See Table 3-2).
4. Enter 3-3-6-8-0. ARM/DISARM code is programmed.
5. Enter **9** 9-8-7-6-5 (default PROGRAM AUTHORIZATION code).
6. Enter 3 for USER AUTHORIZATION Option 3. (See Table 3-1).
7. Enter 2 for CONFIGURATION digit 2. (See Table 3-2).
8. Enter 8-9-7-6-0. ACCESS ONLY code is programmed.

3.2.6.2 PROGRAM AUTHORIZATION CODE EXAMPLE

Program the PROGRAM AUTHORIZATION code as 3-3-5-6-1.

1. Enter **9** 9-8-7-6-5 (default PROGRAM AUTHORIZATION code).
2. Enter 5 for PROGRAM AUTHORIZATION option 5. (See Table 3-1).
3. Enter 9 for CONFIGURATION digit 9. (See Table 3-2).
4. Enter 3-3-5-6-1. PROGRAM AUTHORIZATION code is now 3-3-5-6-1.

Change back to the default PROGRAM AUTHORIZATION code.

1. Enter **9** 3-3-5-6-1 (new PROGRAM AUTHORIZATION code).
2. Enter 5 for PROGRAM AUTHORIZATION Option 5. (See Table 3-1).
3. Enter 9 for Configuration digit 9. (See Table 3-2).
4. Enter 9-8-7-6-5. PROGRAM AUTHORIZATION code is back to default.

3.2.6.3 USER AUTHORIZATION CODE 4 TEMPORARY USE COUNT EXAMPLE

Program an ARM/DISARM code of 4-5-6 for a workman. Assign a USAGE COUNT of 002. Code 4 will work only 2 times.

1. Enter **9** 9-8-7-6-5 (default PROGRAM AUTHORIZATION code).
 2. Enter 4 for USER AUTHORIZATION option 4. (See Table 3-1).
 3. Enter 1 for CONFIGURATION digit 1. (See Table 3-2).
 4. Enter **4** 4-5-6-0-0. USER AUTHORIZATION code is now 4-5-6.
 5. Enter **9** 9-8-7-6-5 (default PROGRAM AUTHORIZATION code).
 6. Enter 6 for CODE 4 TEMPORARY USAGE option 6. (See Table 3-1).
 7. Enter 0-0-2 for 2 uses. Programming is complete.
- NOTE: Repeat steps 5, 6, and 7 to renew code 4 usage.

3.2.6.4 COMMUNICATOR/BATTERY TEST OFFSET TIME EXAMPLE

Assume it is 11 am and you would like the 24 hour automatic test to occur at 1 am. (11 am — 1 am = 14 hours)

1. Enter **9** 9-8-7-6-5 (default PROGRAM AUTHORIZATION code).
2. Enter 7 for COMMUNICATOR/BATTERY TEST option 7. (See Table 3-1).
3. Enter 0-1-4 for an offset of 14 hours. 14 hours from 11 am the test will occur. Each night the test will be sent at 1 am.

3.2.6.5 ENTRANCE DELAY PROGRAMMING EXAMPLE

Set ENTRANCE delay 1 for 40 seconds.

1. Enter **9** 9-8-7-6-5 (default PROGRAM AUTHORIZATION code).
2. Enter 8 for ENTRANCE DELAY 1 option. (See Table 3-1).
3. Enter 0-4-0 for 40 seconds. ENTRANCE DELAY 1 is programmed.

3.3 ADDRESS PROGRAMMING

The purpose of ADDRESS PROGRAMMING is to allow the installer to customize the Z1100 to the specific needs of the installation. This includes Zone Definitions, Exit Time, Entrance Times, Alarm Cutoff Times, Communicator Format and Reporting Codes plus Central Station Telephone Numbers. (See Appendix A.)

The end user is locked out of the ADDRESS PROGRAMMING MODE by the program switch located near the center of the left side of the main control board. The installer must verify that the Program Switch is open before leaving the installation site.

Use the following procedure for keypad ADDRESS PROGRAMMING.

1. Remove system power by turning the Power Switch OFF.
2. Close the Z1100 Program Switch.
3. Restore system power by turning the Power Switch ON. The Z1100 powers up in USER PROGRAMMING. No LEDs will be on.
4. Enter 0 for OPTION 0 (ADDRESS PROGRAMMING mode).
5. Select the address of the feature to program.
See the Memory Map in APPENDIX A.
6. Enter the 3 digit number of the address to be programmed.
For example, select ADDRESS 30 by pressing 0-3-0.
7. The keypad LED's now represent the binary number stored in the address selected in step 6. The POWER LED (1) represents the least significant binary digit, and the FIRE LED (8) represents the most significant binary digit. For programming convenience, each LED's binary value is shown on the inside label of the keypad.

Examples: The binary number stored in each ADDRESS can be calculated by adding up the value of all illuminated LEDs.

() 1	OFF	() 1	OFF	(*) 1	ON
() 2	OFF	() 2	OFF	(*) 2	ON
() 4	OFF	() 4	OFF	(*) 4	ON
() 8	OFF	(*) 8	ON	(*) 8	ON
() 16	OFF	(*) 16	ON	(*) 16	ON
() 32	OFF	(*) 32	ON	(*) 32	ON
() 64	OFF	() 64	OFF	(*) 64	ON
() 128	OFF	() 128	OFF	(*) 128	ON
000		056		255	

8. Enter a 3 digit value into the address.

Examples: 0-1-8 = 18

0-0-5 = 5

1-1-7 = 117

9. The Keypad LEDs will display the programmed value in binary.
10. Press **4** to step to the next address. Example: If you were at ADDRESS 068, pressing **4** will take you to ADDRESS 069.

Press **5** to jump out of ADDRESS PROGRAMMING and back to the running mode.

NOTE: If you leave ADDRESS PROGRAMMING and the Program Switch is still closed, you can re-enter the ADDRESS PROGRAMMING mode with the PROGRAM AUTHORIZATION code and option 0. Enter **9** -9-8-7-6-5. Then enter 0.

CAUTION: Open the Program Switch when ADDRESS PROGRAMMING is complete. Turn Power Switch OFF. Open the Program Switch. Turn Power Switch On.

3.3.1 ADDRESS PROGRAMMING FORMAT

All ADDRESS PROGRAMMING is accomplished using the following 4 step format.

PROGRAM + OPTION + MEMORY + 3 DIGIT
CODE "0" ADDRESS VALUE

3.3.2 PROGRAM CODE

The PROGRAM CODE consists of the command digit 9 followed by the PROGRAM AUTHORIZATION code. **9** 9-8-7-6-5 Entering the PROGRAM CODE places the Z1100 into the USER PROGRAMMING mode. The default PROGRAM AUTHORIZATION code (9-8-7-6-5) can be changed. Once this code is changed, the default code will no longer work.

3.3.3 OPTION 0

OPTION 0 instructs the Z1100 to enter the ADDRESS PROGRAMMING mode. If OPTION 0 is entered and the Program Switch is not closed, a two (2) second error tone will sound and the Z1100 will return to the regular running mode.

3.3.4 MEMORY ADDRESS

The Z1100 system has 128 programmable ADDRESSES. Each ADDRESS is part of the data base which the system uses to perform each function. The Z1100 Memory Map, described in APPENDIX A, shows all 128 addresses that are programmable by the installer.

Upon first entering the ADDRESS PROGRAMMING mode, one may step to an initial memory address location. Three (3) digits must be entered to reach this initial location. If the ADDRESS is less than three (3) digits, leading zeros must be used. Example: ADDRESS 2 = 0-0-2. One may advance forward one (1) location at a time by pressing the **[F]** key.

Backward steps are not possible in the ADDRESS PROGRAMMING mode, nor are forward jumps of more than one (1) location at a time. If it is necessary to jump backward or move forward many steps, simply exit the program mode by pressing the **[X]** key and then re-enter the program mode thereby allowing entry to begin at a new location.

3.3.5 3 DIGIT VALUE

Each ADDRESS location contains a 3 DIGIT VALUE. If a location is to be changed from its present value, three (3) digits must be entered. If the VALUE is less than three (3) digits, leading zeros must be used. Example: 5 should be entered as 0-0-5. Each Memory Address has a defined range as described in APPENDIX A.

3.3.5.1 FAST & SLOW LOOP RESPONSE TIMES (ADDRESSES 000, 001)

Each of the "hardwire" zones can be programmed for either fast or slow loop response. Each of the response times is programmed in 40 millisecond increments (steps). The fastest response is 40 milliseconds (value = 001, 1 step) up to 10.2 seconds (value = 255, 255 steps). Program value desired for fast loop response into ADDRESS 000 and the value desired for slow loop response into ADDRESS 001.

3.3.5.2 USER AUTHORIZATION CODE 1 (ADDRESSES 002, 003, 004)

USER AUTHORIZATION codes as well as the PROGRAM AUTHORIZATION code are stored in a condensed (packed hex) format to conserve memory space. Program these codes ONLY from the USER PROGRAMMING level. (Section 3.2) DO NOT attempt to use ADDRESS level for programming these codes!

3.3.5.3 TWO (2) DIGIT ARMING (ADDRESS 005)

The Z1100 may be selected for two (2) digit arming of the burglar system with the full entry of the USER AUTHORIZATION codes required for disarming. If selected, command **[F]** and the first digit of each code will ARM the burglar system. Other commands are also authorized using only the first digit of each code. To select this feature program ADDRESS 005 with a value of 000. A value of 001-255 disables this feature.

3.3.5.4 USER AUTHORIZATION CODE 2 (ADDRESSES 006, 007, 008)

Program only from USER level PROGRAMMING. (See section 3.2.)

3.3.5.5 NEW EEPROM FLAG (ADDRESS 009)

The new EEPROM flag automatically instructs the Z1100 to re-boot or re-load the EEPROM data base using the factory default settings. If this flag is set, the entire data base will be overwritten with the exception of the Digital Communicator telephone numbers. DO NOT set this flag unless a return to the original factory settings is desired. To set the flag and return to factory default settings, program a value of 255 into ADDRESS 009. Then turn the Power Switch OFF and back ON. When factory settings are restored, ADDRESS 009 returns to its normal value of 000.

3.3.5.6 USER AUTHORIZATION CODE 3 (ADDRESSES 010, 011, 012)

Program only from USER level PROGRAMMING. (See section 3.2.)

3.3.5.7 CODE 4 TEMPORARY USAGE COUNT (ADDRESS 013)

If a USER AUTHORIZATION code 4 is programmed, the value in ADDRESS 013 will determine its number of valid usages. Enter a value of 001-254 usages into ADDRESS 013 for a temporary code 4. Value 255 = permanent use. This is normally programmed with user option 6.

3.3.5.8 USER AUTHORIZATION CODE 4 (ADDRESSES 014, 015, 016)

Program only from USER level PROGRAMMING. (See section 3.2.)

3.3.5.9 ACCESS OUTPUT HOLD TIME (ADDRESS 017)

The Z1100 has the capability of activating door access devices. Connector J-16 provides a positive voltage output whenever a USER AUTHORIZATION code with an ACCESS level configuration digit is entered from the keypad. (See section 3.2.) The amount of time this voltage output remains on, (hold) may be selected by programming a value equal to 001 to 255 seconds into ADDRESS 017.

3.3.5.10 PROGRAM AUTHORIZATION CODE (ADDRESSES 018, 019, 020)

Program only from USER level PROGRAMMING. (See section 3.2.)

3.3.5.11 ZONE 1-8 DEFINITIONS (ADDRESSES 022 THRU 029)

Each zone may be individually defined for use as a Burglar, Fire, Medical, Police or Key zone. Refer to APPENDIX B for calculating the zone definition (3 digit value) for each programmable address. Enter the three (3) digit value for each zone definition into the corresponding address. (ADDRESS 022 = Zone 1, 023 = Zone 2, 024 = Zone 3, 025 = Zone 4, 026 = Zone 5, 027 = Zone 6, 028 = Zone 7, 029 = Zone 8.)

EXAMPLE: A value of 065 programmed into ADDRESS 022 will define Zone 1 as an Instant Burglar Zone.

3.3.5.12 EXIT DELAY TIMER (ADDRESS 030)

The factory default Exit Delay time of 060 seconds may be changed by programming a 3 digit value of 001 to 255 seconds into ADDRESS 030. DO NOT program "000".

3.3.5.13 ENTRANCE DELAY 1 TIMER (ADDRESS 031)

Each delay defined zone may be programmed to respond to one of two (2) entrance delay timers. Entrance Delay 1 might be used for a garage door or alternate point of entry while Entrance Delay 2 is used for the front door. The factory default Entrance Delay 1 time of 030 seconds may be changed by programming a 3 digit value of 001 to 255 seconds into ADDRESS 031. DO NOT program "000".

3.3.5.14 ENTRANCE DELAY 2 TIMER (ADDRESS 031)

The factory default Entrance Delay 2 time of 045 seconds may be changed by programming a 3 digit value of 001 to 255 seconds into ADDRESS 032. DO NOT program "000".

3.3.5.15 BURGLAR ALARM OUTPUT CUTOFF TIME (ADDRESS 034)

Each alarm output has an independent automatic cutoff timer. The factory default Burglar cutoff time of 15 minutes may be changed by programming a 3 digit value of 001 to 255 minutes into ADDRESS 034. 000 may be programmed into this address for "NO" automatic cutoff.

3.3.5.16 FIRE ALARM OUTPUT CUTOFF TIMER (ADDRESS 035)

The factory default Fire cutoff time is set at 000 (no cutoff). This may be changed by programming a 3 digit value of 001 to 255 minutes into ADDRESS 035.

3.3.5.17 POLICE ALARM OUTPUT CUTOFF TIMER (ADDRESS 036)

The factory default Police cutoff time of 15 minutes may be changed by programming a 3 digit value of 001 to 255 minutes into ADDRESS 036. 000 may be programmed into this address for "NO" automatic cutoff.

3.3.5.18 MEDICAL ALARM OUTPUT CUTOFF TIMER (ADDRESS 037)

The factory default Medical cutoff time of 15 minutes may be changed by programming a 3 digit value of 001 to 255 minutes into ADDRESS 037. 000 may be programmed into this address for "NO" automatic cutoff.

3.3.5.19 PULSING BURGLAR ALARM OUTPUT (ADDRESS 038, value = 004)

ADDRESS 038 is a single address that is utilized for multiple programming options, some of which are used and explained in the Digital Communicator section. The Z1100 may be programmed to pulse the Burglar alarm output upon alarm by adding a 004 to the value in ADDRESS 038.

3.3.5.20 SIREN/BELL TEST UPON ARMING (ADDRESS 038, value = 008)

The Z1100 may be programmed to automatically test the siren/bell for 1 second upon arming by adding a 008 to the value in ADDRESS 038.

3.3.5.21 SILENT KEYPAD PIEZO UPON BURGLAR ALARM ACTIVATION (ADDRESS 038, value = 016)

For silent keypad piezo (beeper) upon burglar alarm activation add a 016 to the value in ADDRESS 038.

3.3.5.22 KEYSWITCH CHANGE OF MODES (ADDRESS 038, value = 128)

If a momentary keyswitch is used with the Z1100 for arming or disarming, it may also be used to switch the Interior On or Off and the Delay or Instant modes. Mode switching will occur once per second as long as the keyswitch is turned and held. To activate this feature, add 128 to the value in ADDRESS 038.

3.3.5.23 INTERIOR/DELAY DEFAULT UPON DISARMING (ADDRESS 040)

The Z1100 factory defaults to the Interior On and Delay active mode each time the system is disarmed. This default may be customized to suit each customers operational needs. Select and program a value into ADDRESS 040 according to the default needs of the installation.

VALUE 000 = System defaults to Interior ON and Delay ON.

VALUE 001 = System defaults to Interior OFF and Delay ON.

VALUE 002 = System defaults to Interior ON and Delay OFF.

VALUE 003 = System defaults to Interior OFF and Delay OFF.

3.3.5.24 KEYPAD POLICE SILENT PIEZO (ADDRESS 047)

The Z1100 is factory programmed for audible piezo (keypad beep) upon activation of Keypad Police. For silent Keypad Police program ADDRESS 047 with a value of 000.

3.3.6 RETURNING TO THE FACTORY DEFAULT PROGRAM

The Z1100 system can be returned to the factory default program at any time. This action may be desirable during training on the system or when the program values are unknown. Returning to the factory defaults will not affect any programmed telephone numbers. Use the following procedure to return the Z1100 system to its factory programmed (Default) settings.

1. Enter 9-8-7-6-5 (default PROGRAM AUTHORIZATION code).
2. Enter 0 (ADDRESS PROGRAMMING mode).
3. Enter 0-0-9 (factory bootstrap address).
NOTE: No LEDs should be ON. If any LEDs are ON, press the key to exit, then turn the Power Switch OFF then back ON and return to step 2.
4. Enter 2-5-5. All LEDs should now be ON.
5. Enter to jump out of the programming mode.
6. Turn the Power Switch off.
7. Open the Program Switch.
8. Turn the Power Switch on.
9. System is now returned to default settings.

4. DIGITAL COMMUNICATOR

4.1 OVERVIEW

The Z1100 is equipped with a digital communicator capable of reporting by zone in four (4) different receiver formats. It can dial two (2) different 30 digit telephone numbers using either Rotary or Touch-Tone dialing. The communicator is factory programmed with basic (Default) features and formats. Table 4-1 provides a listing of these factory default features. All communicator programming is done through the Z1100R Keypad in ADDRESS PROGRAMMING mode and is permanently stored in the EEPROM memory. This section includes a description of the communicator's programmable features and operation. Reference APPENDIX A for a full listing of communicator programming features.

4.1.1 FACTORY DEFAULT COMMUNICATOR SETTINGS

The Z1100 Digital Communicator is factory programmed as shown in Table 4-1.

COMMUNICATOR DELAY BEFORE DIALING:	000 Seconds
	(Digital communicator disabled)
DATA FORMAT:	Non Extended
COMMUNICATOR DIAL METHOD:	
1st Telephone number	PULSE (rotary) dialing.
2nd Telephone number	PULSE (rotary) dialing.
COMMUNICATOR DIAL ATTEMPTS:	8 tries
COMMUNICATOR TRANSMISSION FORMAT:	#2
	SESCOA, VERTEX, FRANKLIN FAST FORMAT
	2300 HZ KISSOFF, 1800 HZ DATA
COMMUNICATOR ACCOUNT CODE:	888
COMMUNICATOR ALARM REPORTING CODES:	
ZONE 1 reports code:	3
ZONE 2 reports code:	3
ZONE 3 reports code:	3
ZONE 4 reports code:	3
ZONE 5 reports code:	3
ZONE 6 reports code:	3
ZONE 7 reports code:	3
ZONE 8 reports code:	1
KEYPAD FIRE reports code:	1
KEYPAD POLICE reports code:	2
KEYPAD MEDICAL reports code:	Disabled.
OPENING/EXCEPTION reports code:	Disabled.
CLOSING reports code:	Disabled.
CLOSING w/Shunts reports code:	Disabled.
CANCEL reports code:	Disabled.
ZONE RESTORE reports code:	Disabled.
FIRE TROUBLE reports code:	Disabled.
LOW BATTERY reports code:	Disabled.
24 HOUR TEST reports code:	Disabled.
TELEPHONE NUMBER 1:	Not programmed.
TELEPHONE NUMBER 2:	Not programmed.

**TABLE 4-1
FACTORY DEFAULT COMMUNICATOR SETTINGS**

4.2 COMMUNICATOR DELAY BEFORE DIALING (ADDRESS 033)

This feature allows the user a delay time of 1 - 255 seconds in which to "ABORT" the transmission of an alarm to the Central Monitoring Station. All alarms except a "hardwired" police or keypad activated police alarm may be aborted by disarming the system prior to the expiration of the time programmed into this location. All reporting codes will have this delay time before dialing. If a CANCEL report code is programmed into ADDRESS 062, this code will automatically be sent if the alarm is aborted. The communicator is disabled, (not active) by programming a delay before dialing value of 0-0-0.

4.3 COMMUNICATOR EXTENDED REPORTING (ADDRESS 038, value = 1)

Extended reporting is in the following 2 round transmission format:

1st round. ACCOUNT CODE	ALARM CODE
2nd round. ALARM CODE (3 TIMES)	EXTENDED CODE

In the EXTENDED REPORTING format, the account code and alarm code are reported as the 1st round or line of information. The 2nd round repeats the alarm code three times followed by an extended code. This EXTENDED code, when interpreted along with the alarm code will identify to the Central Station either the zone or the user that caused the transmission. The following is a list of the EXTENDED code definitions.

OPENING/CLOSING code reports USER AUTHORIZATION codes 1 thru 4.

ARMING/DISARMING with a KEY switch reports extended code 5.

KEYPAD ACTIVATED ZONES report as extended code 9.

HARDWIRE ZONE report by zone number 1 - 8.
CANCEL, RESTORE, and FIRE TROUBLE codes report by zone number 1 - 8.

For EXTENDED format, add a 1 to the value in ADDRESS 038. See APPENDIX A.

4.4 COMMUNICATOR SINGLE ROUND REPORTING (ADDRESS 038, value = 2)

The Z1100 is capable of transmitting "MULTIPLE" alarms during an established telephone connection to a Central Station. There are, however, some older types of receivers that can receive only 1 alarm (SINGLE ROUND) per established call. If a "single round only" receiver is being used, or if a single round is desired, the Z1100 may be programmed for 1 alarm per call (SINGLE ROUND) by adding a 2 to the value in ADDRESS 038. See APPENDIX A.

CAUTION: Extended reporting and single round reporting must never be used at the same time. In this condition, the Z1100 will hang up after the first round and attempt a redial. Therefore, the system will never be able to complete the two rounds of transmission.

4.5 COMMUNICATOR TELEPHONE TOUCHTONE® DIALING (ADDRESS 038, value = 32 and/or 64)

The Z1100 is capable of dialing two (2) 30 digit telephone numbers. Both numbers are factory programmed for rotary dialing. If Touchtone service is available, either or both numbers may be programmed for this feature. Programming is accomplished as follows:

- Add 32 to the value in ADDRESS 038 for Telephone #1 Touchtone dial.
- Add 64 to the value in ADDRESS 038 for Telephone #2 Touchtone dial.

See APPENDIX A. NOTE: If only 1 phone number is being dialed, it may be programmed into both phone locations with the 1st being set for Touchtone and the 2nd rotary. Even if there are two different numbers, for backup, it is suggested that one be programmed Touchtone and the other rotary.

4.6 COMMUNICATOR DIAL ATTEMPTS (ADDRESS 041)

The COMMUNICATOR DIAL ATTEMPTS value determines the number of times the digital communicator will attempt to dial the number of the Central Station before giving up. Each time a number is tried, the dial attempts counter reduces (decrements) by one. If only the first number is programmed and that number is not reached, the attempt counter will be decremented and the system will attempt to dial using the second number. If the second number is found not active, the attempt counter will be decremented and the system will switch back to the first number. This means that if only one number is programmed, and the desired attempts is 10 tries, then 20 must be programmed into ADDRESS 041. If two numbers are programmed and the desired attempts is 10, then 10 must be programmed into ADDRESS 041.

Example: The second telephone number is not programmed and the desired attempts = 8. The communicator will attempt to dial both numbers and the dial attempts will decrement 1 time per attempt. Enter 016 into ADDRESS 041 for 8 attempts when only the first telephone number is programmed.

4.7 COMMUNICATOR DATA TRANSMISSION FORMATS (ADDRESSES 042, 043)

Each telephone number may be programmed with its own data transmission format as described below:

1. Ademco, Adcor, Vertex, or Silent Knight slow format.
1400 Hz Acknowledge/Kissoff, 1900 Hz Data, 10 Baud.
51/49 millisecond duty cycle.
600 millisecond inter-digit delay.
2. (Default) Acron, SESCOA, Vertex, DCI, Franklin fast format. 2300 Hz Acknowledge/Kissoff, 1800 Hz Data, 20 Baud.
30/20 millisecond duty cycle.
800 millisecond inter-digit delay.
3. Radionics super fast format, no parity.
2300 Hz Acknowledge/Kissoff, 1800 Hz Data, 40 Baud.
13/12 millisecond duty cycle.
400 millisecond inter-digit delay.

4. Silent Knight fast format.
1400 Hz Acknowledge/Kissoff, 1900 Hz Data, 15 Baud.
40/30 millisecond duty cycle.
560 millisecond inter-digit delay.

ADDRESS 042 contains Telephone #1 format. ADDRESS 043 contains Telephone #2 format. See APPENDIX A.

NOTE: The Z1100 does not support receivers with pulsing or steady hold feature.

4.8 COMMUNICATOR ACCOUNT CODE (ADDRESSES 044, 045, 046)

The 1st digit of the Digital Communicator Account code resides in ADDRESS 044 (most significant digit), the 2nd digit in ADDRESS 045, and the 3rd digit in ADDRESS 046 (least significant digit). Each digit has a range of 000 - 015 allowing hex characters. NOTE: In programming communicator account codes, report codes, and telephone numbers, the value of 000 is translated by the system to 010. See APPENDIX A.

Examples:

	ADDRESS			Account Code
	044	045	046	
VALUE	001	002	003	= 123
	008	008	008	= 888
	006	004	015	= 64F

4.9 COMMUNICATOR ALARM REPORTING CODES (ADDRESSES 048 - 058)

The eight (8) hardwire zones 1-8, and the three (3) Keypad (Fire, Police and Medical) activated zones may be programmed to report individual zone codes. Valid range is 000 to 015 with the 011 to 015 being hexadecimal reporting codes. Any of the reporting zones may be disabled from reporting by programming a non-valid code (example 255) into the corresponding address. See APPENDIX A.

4.10 COMMUNICATOR OPENING/CLOSING REPORTING (ADDRESSES 059 - 061)

The OPENING report code is enabled by programming a valid reporting code (000 - 015) into ADDRESS 059. When enabled, that code will be transmitted each time the system is disarmed. A "SYSTEM RESTORAL/EXCEPTION OPENING" report may be enabled by adding 16 to a valid reporting code in ADDRESS 059. An opening/exception is different from a regular opening in that a code is sent "only" after disarming following an alarm activation.

The CLOSING report code resides in ADDRESS 060. Enter a valid reporting code to enable closing reporting. A "CLOSING w/shunts" report code (000 - 015) may be programmed into ADDRESS 061. Closing w/shunts report code is special in that it is sent only after arming with ONE or MORE ZONES SHUNTED.

4.11 COMMUNICATOR CANCEL REPORTING CODE (ADDRESS 062)

The CANCEL report code is enabled by programming a valid reporting code (000 - 015) into ADDRESS 062. When enabled, that code will be transmitted whenever any hardwire zone transmission is aborted.

4.12 COMMUNICATOR ZONE RESTORE REPORTING CODE (ADDRESS 063)

The ZONE RESTORAL report code is enabled by programming a valid reporting code (000 - 015) into ADDRESS 063. When enabled, that code will be transmitted whenever a hardwire zone alarm triggers and the zone returns to normal (restores) while the system is still armed. Restore will report by zone if extended format is programmed.

4.13 COMMUNICATOR FIRE TROUBLE REPORTING CODE (ADDRESS 064)

The FIRE TROUBLE report code is enabled by programming a valid report code (000 - 015) into ADDRESS 064. When enabled, any hardwire zone defined as Fire, will send a FIRE TROUBLE report code if its loop opens. Fire trouble will report by zone if extended format is used.

4.14 LOW BATTERY REPORTING CODE (ADDRESS 065)

The LOW BATTERY report code is enabled by programming a valid reporting code (000 - 015) into ADDRESS 065. The battery is tested once every 24 hours automatically, or manually from the keypad for 5 seconds at 2.5 amps. If the battery voltage at the end of the test reads less than 11.25 volts, a low battery report code will be transmitted.

4.15 COMMUNICATOR 24 HOUR TEST REPORTING CODE (ADDRESS 066)

The 24 HOUR TEST report code is enabled by programming a valid report code (000 - 015) into ADDRESS 066. When enabled, a test code will be transmitted to the Central Station once every 24 hours. User programming option 7 allows the user to shift the 24 hour test time into a time window desired by the Central Station.

4.16 COMMUNICATOR TELEPHONE NUMBERS (ADDRESSES 068-097, 098-127)

The digital communicator may dial two (2) thirty (30) digit telephone numbers for reporting. A dialable digit may be any value from 000 - 009. If using Touchtone, "*" = 011 and "#" = 012. For a 3 second delay between dialed digits, an entry of 013 is used. The first digit of telephone 1 should be entered into ADDRESS 068 with each succeeding digit located in the address following the last. The address immediately following the last dialed digit must be programmed with an invalid digit (example 255) to mark the end of that telephone number. The first digit of telephone 2 begins in ADDRESS 098.

Additional Phone Company Information

INCIDENCE OF HARM

In the unlikely event that the Z1100 dialer should ever cause harm to the telephone network, the telephone company will notify the telephone subscriber that temporary discontinuance of service may be required; however, where prior notice is not practicable, the telephone company may temporarily discontinue service. In the case of temporary discontinuance, the telephone company shall promptly notify the telephone subscriber who will be given the opportunity to correct the situation. The customer also has the right to bring a complaint to the FCC if he feels the disconnection is not warranted.

CHANGES IN TELEPHONE COMPANY EQUIPMENT OR FACILITIES

The telephone company may make changes in its communications facilities, equipment, operations or procedures, where such action is reasonably required and proper in its business. Should any such changes render the Z1100 dialer incompatible with the telephone company facilities, the customer shall be given adequate notice to make modifications to maintain uninterrupted service.

Telephone Company Requirements

NOTIFICATION

All connections to the telephone network must be made through standard plugs and standard telephone company jacks, or equivalent, in such a manner as to allow for easy and immediate disconnection of the alarm equipment. If the connecting cord is unplugged from the jack there shall be no interference to the telephone equipment still connected to the telephone network. Before connecting the Z1100 to the phone network the telephone company must be notified for the installation of an USOC RJ31-X jack. The telephone company will need the following information:

1. The phone number to which the Z1100 will be connected.
2. The ringer equivalence: 0.0B.
3. The manufacturer: Sentrol, Inc.

Notify the telephone company if the Z1100 is removed from the premises and the RJ31-X jack is no longer needed.

MALFUNCTIONS OF EQUIPMENT

In the unlikely event that the Z1100 should ever fail to operate properly, it should be disconnected from the RJ31-X jack to determine if the problem is with the telephone network or with the Z1100. If a problem is found with the dialer, leave disconnected until repaired or replaced.

The FCC prohibits customer-provided terminal equipment be connected to party lines or to be used in conjunction with coin telephone service.

CORRECT WIRING OF THE RJ31-X JACK

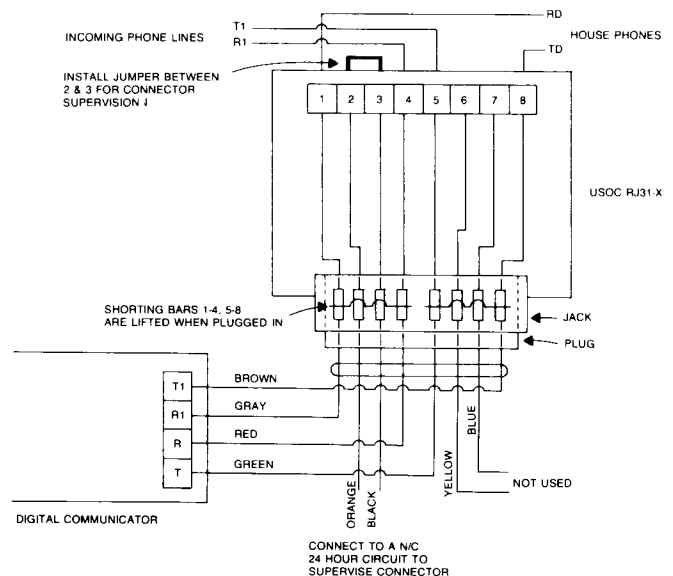

5. INSTALLATION

5.1 PLANNING THE INSTALLATION

The first step in the installation of any multi-zone system is planning the job. Programming can be minimized by analyzing the job requirements and comparing these with the factory default program.

The ZONE PLANNING GUIDE, APPENDIX B, has been developed to aid in system design. To use this guide, decide what characteristics you want for each zone and insert the values in the appropriate boxes. Add up the values for each zone and then enter the TOTAL value into the corresponding zone definition ADDRESS.

Figure 5-3 provides a typical Fire and Burglary installation layout. This may be used as a guide in planning the specific installation for the Z1100.

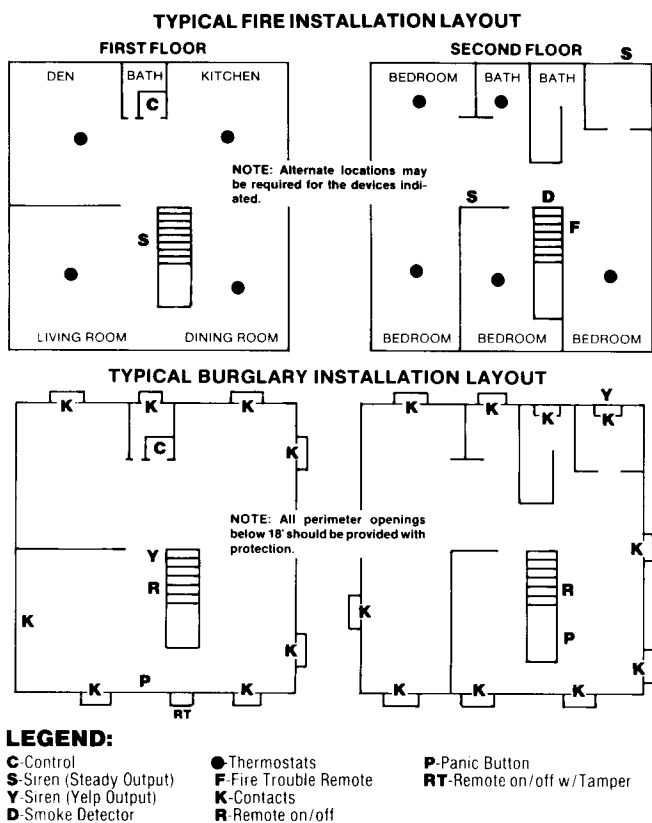

NOTE: Installation of fire detection equipment in all rooms and areas of the household is suggested for early warning fire detection.

A smoke detector should be installed in each separate sleeping area (the vicinity of, but outside of the bedrooms) and heat or smoke detectors in living rooms, dining rooms, bedrooms, kitchens, hallways, attics, furnace rooms, closets, utility and storage rooms, basements and attached garages.

PREPARATION AND EDUCATION ARE OF PRIME IMPORTANCE IN FIRE PREVENTION. ESTABLISH A HOUSEHOLD EMERGENCY EVACUATION PLAN IN THE EVENT OF FIRE.

1. Evaluate possible escape routes from your home.
2. Select escape routes from each room.
3. Rooms on the second floor should have a rope ladder. (Be sure it will reach the ground.)
4. Draw a rough sketch of your escape plan so that everyone is familiar with it.
5. Practice your escape plan to assure that everyone knows what they have to do.
6. Establish a meeting place outside where your family is to report.
7. Advise the local fire authority that you have installed a fire alarm system.

FIGURE 5-3

5.2 HARDWARE INSTALLATION

1. Remove the packing from the Z1100 control box. Set packaging aside until all pre wiring is completed.
2. Remove control box knockouts as necessary for wiring.

3. Mount the control box in a secure, dry location. The control box has six mounting holes. Use the top center hole to temporarily mount and provide a reference for leveling the box and aligning the other five holes.
4. Attach an earth ground wire to terminal 19. Use 14 gauge (or larger) wire and connect this wire to a ground stake. Do not use conduit, gas pipe, or water pipe for a ground reference. CAUTION: DO NOT earth ground the negative side of the power supply, as this will greatly reduce lightning/transient protection. NOTE: DO NOT plug in the transformer or connect the battery at this time.
5. Connect all wiring to the box mounted terminal strips as shown in Figure 5-1.
6. Turn Power Switch OFF (down position). This switch is located below terminal 19. (See Figure 5-1.)
7. Plug in the Z1100 control board. (See Figure 5-4)
8. Plug in the J-16 wiring harness. Connector J-16 is a 12 wire female connector. Figure 5-1 shows the corresponding male connector for the J-16 harness.
9. Install and connect auxiliary devices such as the JDS-108 and the MPI-295 as required by the installation.
10. Verify that the Program Switch is OPEN.

NOTE: The normal position for this switch is OPEN.

11. Plug the 18 Volt, 35VA transformer into a 24 hour receptacle.
12. Connect the 12 Volt, 6AH battery (Moose part #B-1260). Observe polarity: RED wire to "+" and BLACK wire to "-" terminals. CAUTION: In order to achieve optimum performance, use only Moose 12 Volt, 6AH sealed lead acid battery (#B-1260). Use of any other battery may degrade system performance and possibly void the warranty.

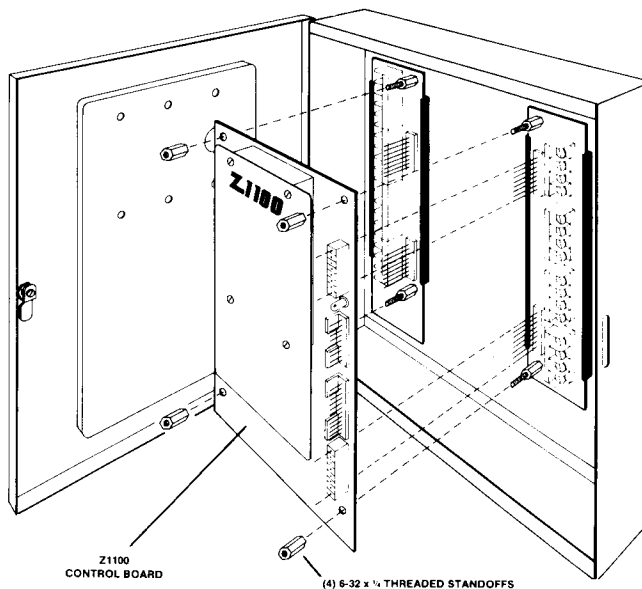

FIGURE 5-4

- If the system can be used with the factory default settings, proceed to SYSTEM TESTING (Section 5.7). If the planned system requires a lot of changes (such as re-defining zones), use either the Z1100R keypad or the Z1100P Programmer to program the system. The **Z1100 ZONE PLANNING GUIDE**, **APPENDIX B** and **THE Z1100 MEMORY MAP**, **APPENDIX A** are provided to aid in establishing a custom program.

NOTE: It is a good policy to change the default AUTHORIZATION codes last or instruct the user in code modification.

5.3 AUXILIARY POWER (Terminal 29 is positive and 28 is negative.)

12 Volts DC is supplied by the Z1100 to power motion detectors, relay boards, and other accessories.

5.4 FIRE POWER (Terminal 30 is positive and 28 is negative.)

12 Volts DC for powering Fire Alarm devices.

5.5 SMOKE POWER (Terminal 31 is positive and 28 is negative.)

12 Volts DC is supplied for powering smoke detectors. Smoke detectors can be reset (unlatched) from the keypad with command 7.

NOTE: Maximum continuous current drain should not exceed 900 milliamps from terminals 14, 29, 30, 31, and connector J-16. Alarm condition current drain should not exceed 2.5 amps.

5.6 ALARM/FUNCTION OUTPUTS (Connector J-16)

Outputs of the Z1100 system are present at Connector J-16. The function of each output is shown in Table 5-2. Each of these outputs (3 through 12) is capable of triggering relay K1, relay K2, or auxiliary devices such as the JDS-108 which require less than 50 milliamps at 12 Volts DC.

1. Red (+)	+12V Auxiliary Power
2. Black (—)	Negative
3. White	Access Output (+)
4. Green	Lamp Output (+)
5. Brown	Pre-Alarm Output (+)
6. Blue	Burglar zone Status (+)
7. Orange	Violation Output (+)
8. Yellow	Armed Output (+)
9. PURPLE	MEDICAL/AUX 2 ALARM OUTPUT (+)
10. GREY	POLICE/AUX 1 ALARM OUTPUT (+)
11. PINK	FIRE ALARM OUTPUT (+)
12. TAN	BURGLAR ALARM OUTPUT (+)

Table 5-2: Connector J-16 Alarm Outputs

NOTE: Multiple connector J-16 Outputs can be connected to the same low current trigger terminal. For example, POLICE and MEDICAL outputs (J-16, 9 and 10) can both be connected to terminal 23. J-16 outputs cannot directly drive any device that requires more than 50 milliamps (0.05 amp) of current. These devices must be driven with the general purpose relays K1 or K2.

5.7 SYSTEM TESTING

Before testing the system, either notify the alarm monitoring service or temporarily disconnect the digital communicator. Each zone (and sensors within each zone) must be tested in order to verify proper system performance.

5.7.1 GENERAL SYSTEM TESTING - BURGLAR ZONES

- Secure all burglar detection devices (doors, windows, and motion detectors).
- Enable the loop TEST feature with command 8 followed by an AUTHORIZATION code. Enter $\boxed{8}$ -2-4-5.
- Test all burglar devices. The Z1100R Keypad beeps continuously if a zone is violated during loop TEST.
- Turn off loop TEST by pressing the $\boxed{*}$ key.

5.7.1.1 TESTING BURGLAR INSTANT ZONES

- Arm the system. Enter $\boxed{1}$ -2-4-5.
- The ARMED LED will be on and the keypad will beep six times to signal that the system is armed.
- The keypad will beep until the exit delay time expires (factory set at 60 seconds). All burglar zones have exit delay.
- Exit time has expired when the keypad stops beeping.
- Violate a burglar instant zone.
- The keypad will beep and the audible alarm will sound.
- The ARMED LED will blink (burglar alarm memory).
- Disarm the system. Enter $\boxed{1}$ -2-4-5.
- The ARMED LED will continue to blink until the $\boxed{*}$ key is pressed.
- Re-arm the system and test any other burglar instant zones using the above procedure.

5.7.1.2 TESTING BURGLAR DELAY ZONES

- Arm the system. Enter $\boxed{1}$ -2-4-5.
- The ARMED LED will be on and the keypad will beep six times to signal that the system is armed.
- The keypad will beep until the exit delay time expires (factory set at 60 seconds). All burglar zones have exit delay.
- Exit time has expired when the keypad stops beeping.
- Violate a delay zone.
- The keypad pre-alarm will sound for the entrance delay time. Let the entrance time expire.
- The keypad will beep and the audible alarm will sound.
- The ARMED LED will blink (alarm memory).
- Disarm the system. Enter $\boxed{1}$ -2-4-5.
- The ARMED LED will continue to blink until the $\boxed{*}$ key is pressed.
- Re-arm the system and test all other burglar delay zones. Use the above procedure.

5.7.2 TESTING FIRE ZONES

FIRE zones are 24 hour zones. If the circuit opens, a TROUBLE signal is generated. If the circuit closes (shorts), a FIRE alarm occurs.

5.7.2.1 TESTING FIRE TROUBLE

1. Clear all fire detection devices.
2. Open either side of the FIRE zone.
3. The keypad will beep rapidly.
4. FIRE LED will blink (fire trouble indication).
5. Press the **[*]** key to silence keypad.
6. FIRE LED still blinking.
7. Restore FIRE zone to normal condition.
8. FIRE LED will be off.

5.7.2.2 TESTING FIRE ALARM

1. Clear all fire detection devices.
2. Activate a smoke detector or other fire sensor.
3. The keypad will beep rapidly.
4. FIRE alarm output will activate.
5. FIRE LED will be on (fire alarm indication).
6. Press the **[*]** key to silence audible devices.
7. FIRE LED still on.
8. Acknowledge FIRE alarm with command 1 and an AUTHORIZATION code. Enter **[*]** -2-4-5.
9. The FIRE LED will blink if detectors are still latched.
10. Unlatch detectors with command 7 and an AUTHORIZATION code. Enter **[*]** -2-4-5.
11. FIRE LED will be off. See Section 2.7 and 2.8 if the POWER LED is blinking.

5.7.3 TESTING POLICE/AUX 1 ZONES

The POLICE/AUX 1 zone is a 24-hour zone. If Police is programmed silent, no LEDs will light and the keyboard will not sound.

1. Clear all police detection devices.
2. Activate a police zone device.
3. The keypad will beep rapidly.
4. POLICE/AUX 1 alarm output will activate.
5. POLICE LED (INTERIOR OFF LED) will blink.
6. Acknowledge POLICE/AUX 1 alarm with command 1 and an AUTHORIZATION code. Enter **[*]** -2-4-5.
7. POLICE/AUX 1 LED will be off.

5.7.4 TESTING MEDICAL/AUX 2 ZONES

The MEDICAL/AUX 2 zone is a 24-hour zone.

1. Clear all medical detection devices.
2. Activate a medical zone device.
3. The keypad will beep slowly.
4. MEDICAL/AUX 2 alarm output will activate.
5. MEDICAL/LED (INSTANT LED) will blink.
6. Press the **[*]** key to silence audible devices.
7. Acknowledge MEDICAL/AUX 2 alarm with command 1 and an AUTHORIZATION code. Enter **[*]** -2-4-5.
8. MEDICAL/AUX 2 LED will be off.

5.7.5 TESTING DIGITAL COMMUNICATOR

Connect the Digital Communicator to the telephone lines or enable the communicator as appropriate. See Figure 5-1.

1. Arm the system. Enter **[*]** -2-4-5.
2. After exit time expires, violate an instant burglar zone.
3. The DIALER ACTIVE LED will be on. (See figure 5-1.)
4. When the LED goes out, disarm the system. Enter **[*]** -2-4-5.
5. Verify that the Central Monitoring Station received the proper signals.
6. Test additional features as required by the Central Monitoring Station.

CONNECTOR J-16

Maximum current drain from each Output (3 through 12) should not exceed 50 milliamps (0.05 A). All Outputs are positive voltages (+12 Volts).

TERMINAL	FUNCTION	DESCRIPTION
1. RED (+)	Aux. Power (Positive)	12 volts DC power for motion detectors and other accessories. This output is fused at 2.5 amps. Maximum continuous current drain from 14, 29, 30, 31 and connector J-16 outputs should not exceed 900 milliamps. Combined alarm condition current drain should not exceed 2.5 amps.
2. BLACK (-)	Common (Negative)	Common power supply negative.
3. WHITE	Access Output	Provides a positive output when an ACCESS code is entered at the keypad. ADDRESS 017 sets the amount of time that this Output is active.
4. GREEN	Lamp Output	Provides a 2 minute output when: (1) any keypad key is pressed (2) exit or entrance delay time starts (3) any type of alarm has occurred (4) Ac power fails. This Output can be used to trigger a 12 Volt DC AC line carrier system.
5. BROWN	Pre Alarm	Output for a remote or auxiliary pre-alarm.
6. BLUE	Burglar zone status	Output for a remote or auxiliary burglar zone status indicator.
7. ORANGE	Violation	Output upon alarm activation. May be used for a strobe or auxiliary indicator. This Output stays active until the system is reset or disarmed.
8. YELLOW	Armed	Output for a remote or auxiliary burglar armed status indicator.
9. PURPLE	Medical	Alarm output upon activation of either a keypad or hardwired medical activation.
10. GREY	Police	Alarm output upon activation of either a keypad or hardwired police activation.
11. PINK	Fire	Alarm output upon activation of either a keypad or hardwired fire activation.
12. TAN	Burglar	Alarm output upon activation of either any burglar defined zone.

Z1100R KEYPAD MOUNTING

ZONE DEFINITION AREA
USE PERMANENT FELT-TIP
MARKER

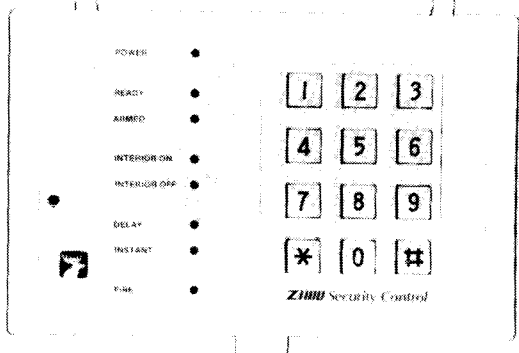

DOOR CLOSED

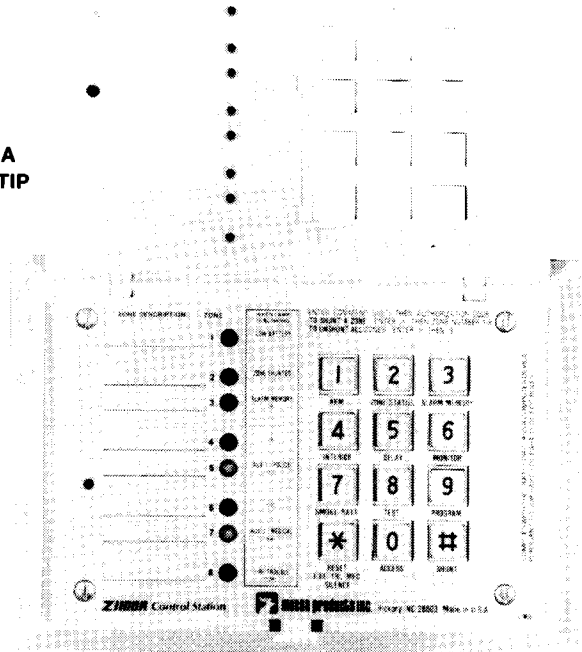

DOOR OPEN

ELECTRICAL CONNECTIONS

Z1100R PIN NO.	WIRE COLOR	FUNCTION	Z1100 TER. NO
PIN 1	BLACK	NEGATIVE	13
PIN 2	WHITE	DATA OUT REMOTE	16
PIN 3	GREEN	DATA IN REMOTE	15
PIN 4	RED	POSITIVE +12V	14

FLATHEAD #6 BACKPLATE
SCREWS (USER SUPPLIED)
USE #6 COUNTERSUNK FLATHEAD
SCREWS ONLY - USE OF OTHER
TYPES MAY CAUSE ELECTRICAL DAMAGE.

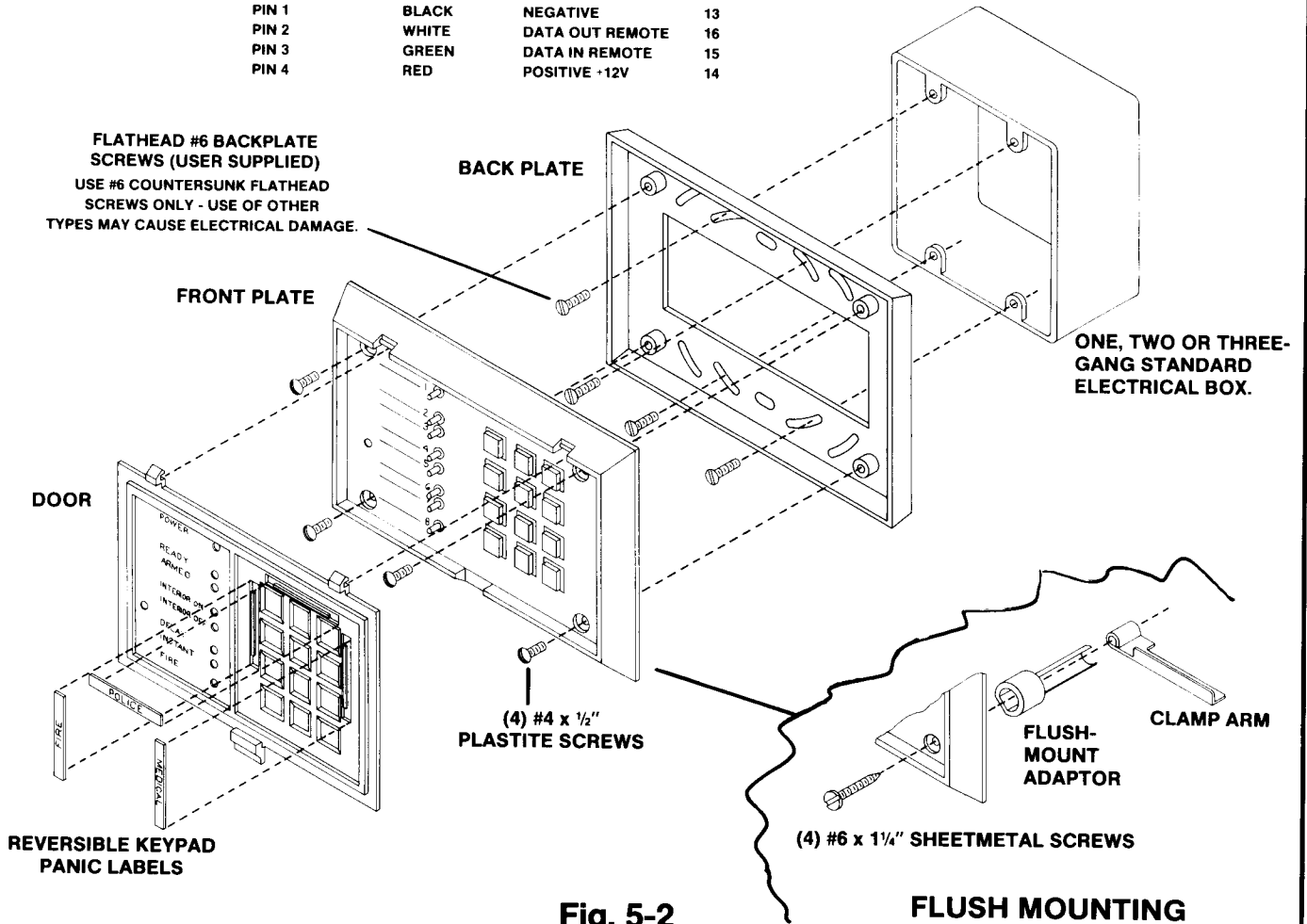

Fig. 5-2

FLUSH MOUNTING

For Burglar Defined Zones
 Jumper J1-J8 may be cut for a normally-closed loop
 with no End-Of-Line resistor.

Close PROGRAM SWITCH for Keypad
 Address programming. Open after programming.

Factory
 Default
 Programming

★ 2200-ohm
 EOL resistor

- Burglar Delay 1 ZONE 1
- Burglar Delay 2 ZONE 2
- Burglar Interior ZONE 3
- Burglar Perimeter ZONE 4
- Burglar Perimeter ZONE 5
- Burglar Perimeter ZONE 6
- Burglar Perimeter ZONE 7
- Fire Use UL Listed N.O. Fire Detection Devices With EOL Resistor ZONE 8

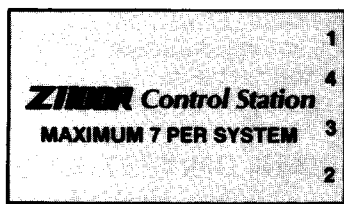
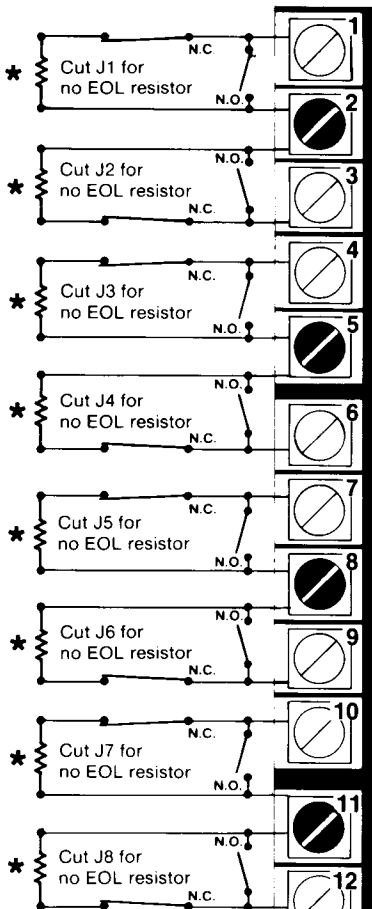

18 VAC UL CLASS II
 Listed transformer
 35VA minimum
 50/60 Hz
 Do not connect to a
 receptacle controlled
 by a switch.

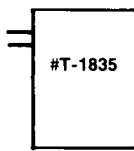

LIGHTNING PROTECTION

The control panel must be earth-grounded in order for lightning/transient protection to be effective. The ground-connection should be made to a dedicated metal-stake as close to the control as possible. DO NOT use conduit, gas pipe, or telephone-equipment grounds.

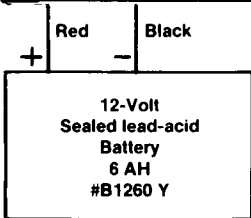
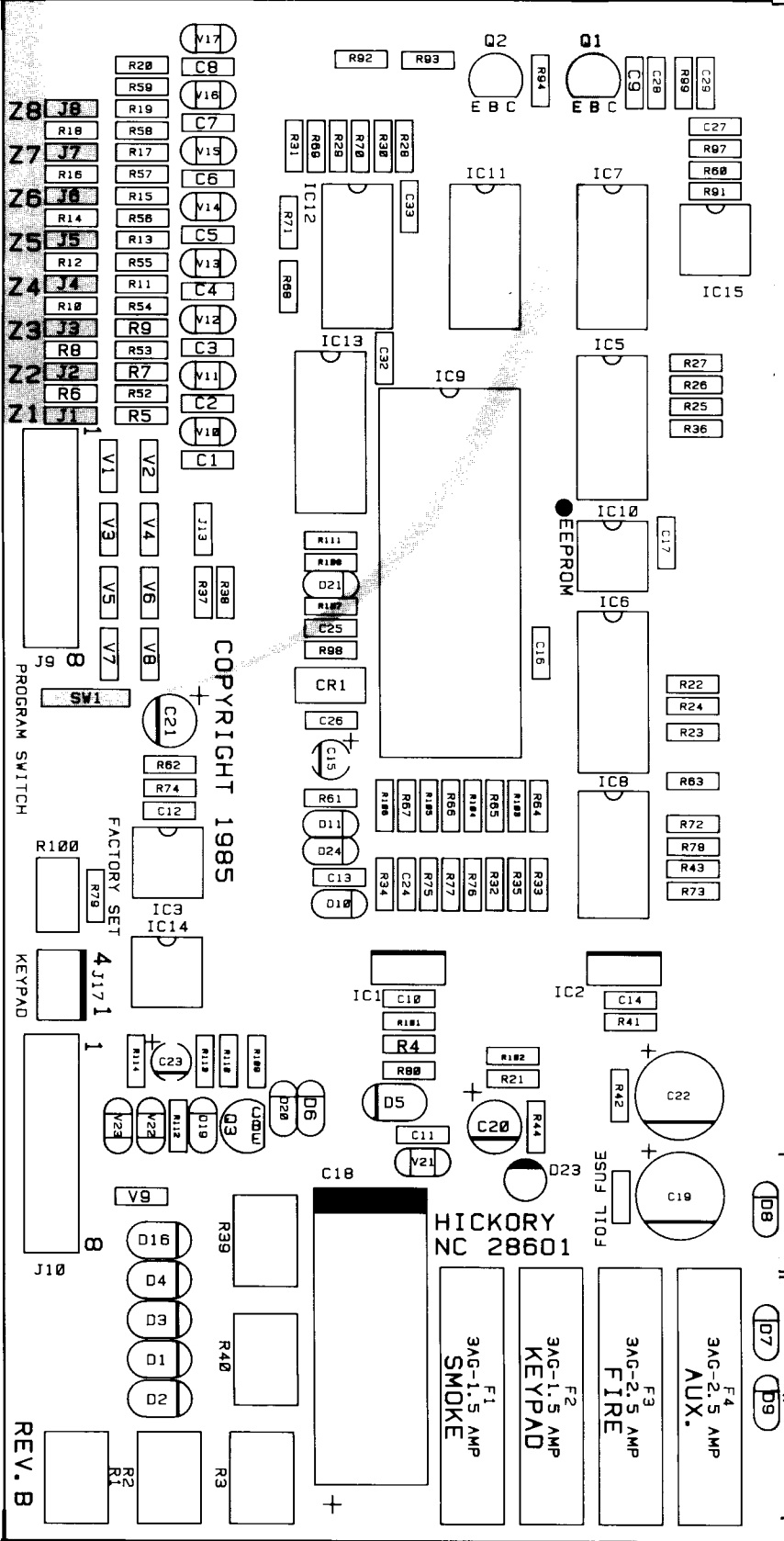
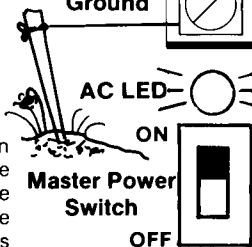

Float-charge voltage: 13.6 to 13.8 Volts
 Maximum charge-current: 500 milliamps.
 Quiescent charge-current: 20 milliamps.
 Replace every 3 to 5 years.

COMPLIES WITH PART 68 FCC RULES. RINGER EQUIVALENCE: 0.0B. USE USOC RJ-31X CONNECTOR. COMPLIES WITH THE LIMITS FOR CLASS B COMPUTER DEVICES IN ACCORDANCE WITH THE SPECIFICATIONS OF PART 15 OF FCC RULES.

Reference Page 17 for Telephone Cord Supervision

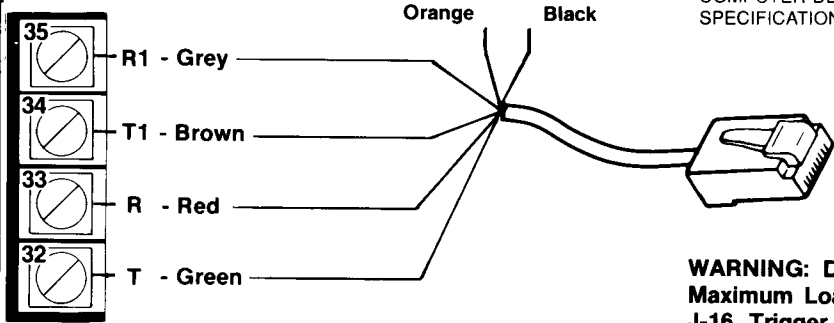

TC-3 Telephone Cord

WARNING: Do not exceed 50 Milliamp Maximum Load on each of pins 3-12 of J-16. Trigger Relay K-1 or K-2 to switch large loads.

MOOSE PRODUCTS INC.

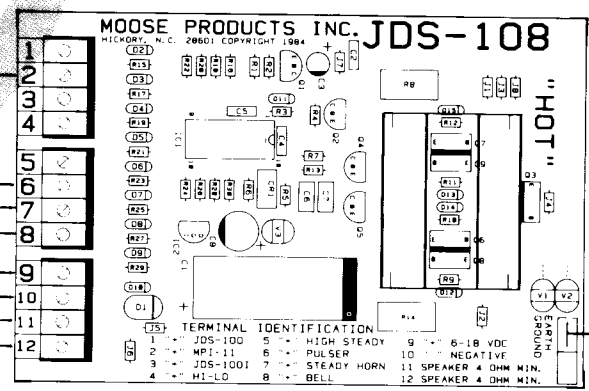
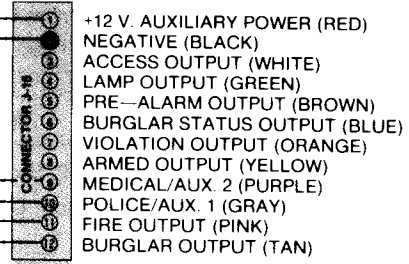
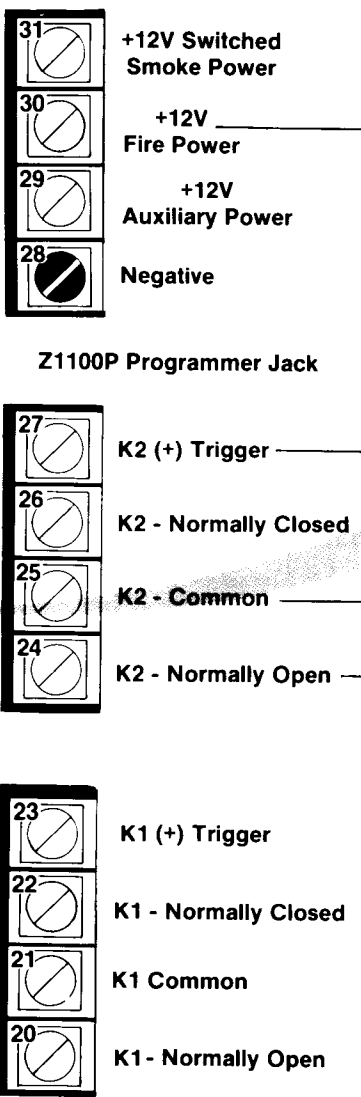
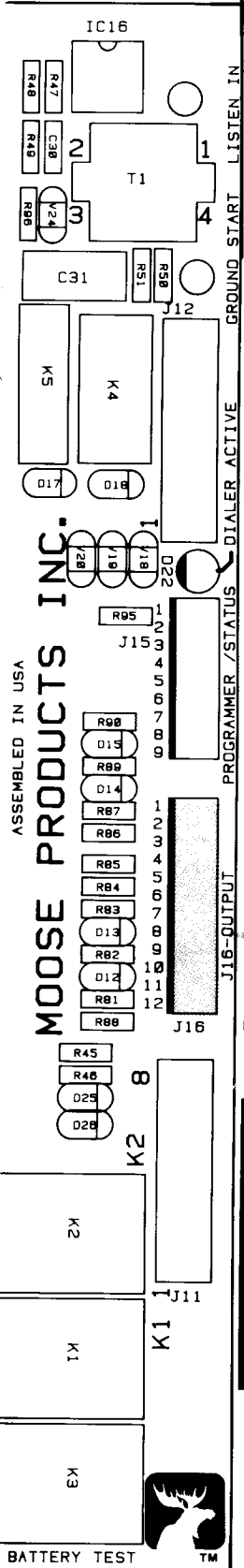

MOOSE PRODUCTS INC. JDS-108
MULTI-CHANNEL SIREN DRIVER
JDS-108
SPEAKER - MPI-30, MPI-34, MPI-35
MPI-35F, MPI-39, MPI-8

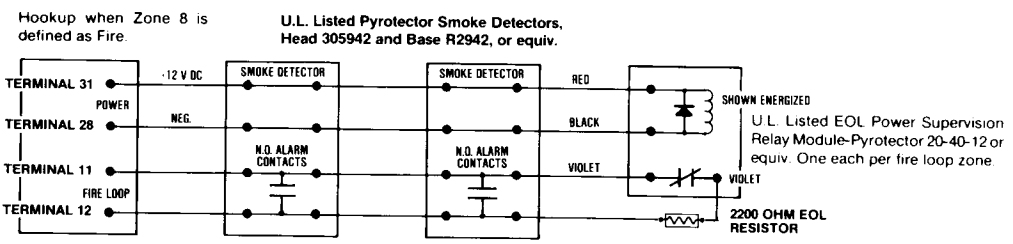

Suggested UL Burglar and Fire Alarm Audible Hookup

Fig. 5-1

APPENDIX A

Z1100 MEMORY MAP

ADDRESS	DESCRIPTION	VALUES	
		FACTORY	NEW
000	FAST loop response. 40 milliseconds to 10.2 seconds.	002	---
001	SLOW loop response. 40 milliseconds to 10.2 seconds. (40 msec. increments. 001 = 40 msec., 008 = 320 msec. etc.)	008	---
002	USER AUTHORIZATION code 1. Stored in condensed Digit 1 & 2	018	X X X
003	(packed) format. Program from USER Digit 3 & 4	069	X X X
004	LEVEL ONLY! Digit 5 & 6	000	X X X
005	Two digit ARMING feature. 000 = Enables 255 = Disables	255	---
006	USER AUTHORIZATION code 2. Stored in condensed Digit 1 & 2	255	X X X
007	(packed format. Program from USER Digit 3 & 4	255	X X X
008	LEVEL ONLY! Digit 5 & 6	255	X X X
009	New EEPROM FLAG. 255 = Reload factory programming.	000	---
010	USER AUTHORIZATION code 3. Stored in condensed Digit 1 & 2	255	X X X
011	(packed) format. Program from USER Digit 3 & 4	255	X X X
012	LEVEL ONLY! Digit 5 & 6	255	X X X
013	AUTHORIZATION code 4 USAGE COUNT. 001 to 255 Usages.	255	---
014	USER AUTHORIZATION code 4. Stored in condensed Digit 1 & 2	255	X X X
015	(packed) format. Program from USER Digit 3 & 4	255	X X X
016	LEVEL ONLY! Digit 5 & 6	255	X X X
017	ACCESS (door strike) output time. 001 to 255 seconds.	020	---
018	PROGRAM AUTHORIZATION CODE. Stored in condensed Digit 1 & 2	153	X X X
019	(packed) format. Program from USER Digit 3 & 4	135	X X X
020	LEVEL ONLY! Digit 5 & 6	101	X X X
021	SYSTEM USE ONLY - DO NOT PROGRAM!	000	X X X
022	ZONE 1 Definition.	064	---
023	ZONE 2 Definition.	072	---
024	ZONE 3 Definition.	081	---
025	ZONE 4 Definition.	065	---
026	ZONE 5 Definition.	065	---
027	ZONE 6 Definition.	065	---
028	ZONE 7 Definition.	065	---
029	ZONE 8 Definition.	066	---
030	EXIT Delay time. Odd Value = Silent Even Value = Audible 001 to 255 seconds.	060	---
031	ENTRANCE Delay 1 time. 001 to 255 seconds.	030	---
032	ENTRANCE Delay 2 time. 001 to 255 seconds.	045	---
033	COMMUNICATOR Delay before dial. 000 = Communicator Disabled 000 to 255 seconds.	000	---

ADDRESS	DESCRIPTION	VALUES			
		FACTORY	NEW		
034	BURGLAR Output Cutoff time. 000 to 255 minutes. 000 = No Automatic Cutoff.	015	----		
035	FIRE Output Cutoff time. 000 to 255 minutes. 000 = No Automatic Cutoff.	000	----		
036	POLICE Output Cutoff time. 000 to 255 minutes. 000 = No Automatic Cutoff.	015	----		
037	MEDICAL Output Cutoff time. 000 to 255 minutes. 000 = No Automatic Cutoff.	015	----		
038	SYSTEM CONFIGURATION. Select desired system options. Add values of features selected and place total value into address 038. 000 to 255.		000	----	
	VALUE	DESCRIPTION			
	1	Communicator Extended Reporting			
	2	Communicator Single Round Reporting <small>Multiple alarm reporting is standard.</small>			
	4	Pulsing Burglar Alarm Output			
	8	Siren/Bell 1 second test upon arming			
	16	Silent Keypad Piezo (Burglar activation)			
	32	Telephone number 1 touch tone dial			
	64	Telephone number 2 touch tone dial			
	128	Keyswitch change of Interior and Delay modes			
		TOTAL Enter into Address 038			
	039	SYSTEM USE ONLY - DO NOT PROGRAM!			000
040	Interior/Delay default. 000 to 003. ADDRESS 040 sets the INTERIOR ON/OFF, DELAY, INSTANT DEFAULT setting on Disarming:		000	----	
	VALUE	INTERIOR			DELAY
	000 =	ON			ON
	001 =	OFF			ON
	002 =	ON			OFF
	003 =	OFF			OFF
041	COMMUNICATOR dial attempts. DO NOT PROGRAM 000.	008	----		

ADDRESS	DESCRIPTION		VALUES	
			FACTORY	NEW
042	Telephone number 1 data format.	001 to 004.	002	----
043	Telephone number 2 data format.	001 to 004.	002	----
	DATA-TRANSMISSION FORMATS:	VALUE		
	Ademco, Adcor, Vertex, Silent Knight slow format 1400 Hz Kisoﬀ, 1900 Hz Data, 10 Baud.	001		
	Acron, Sescoa, Vertex, DCI, Franklin, fast format 2300 Hz Kisoﬀ, 1800 Hz Data, 20 Baud.	002		
	Radionics super fast format, no parity, 2300 Hz Kisoﬀ, 1800 Hz Data, 40 Baud.	003		
	Silent Knight fast format 1400 Hz Kisoﬀ, 1900 Hz Data, 15 Baud.	004.		
044	Account code digit 1. (MSD)	000 to 015.	008	----
045	Account code digit 2.	000 to 015.	008	----
046	Account code digit 3. (LSD)	000 to 015.	008	----
047	Keypad POLICE Piezo. 255 = Audible	000 = Silent Piezo.	255	----
048	ZONE 1 Reporting code.	000 to 015.	003	----
049	ZONE 2 Reporting code.	000 to 015.	003	----
050	ZONE 3 Reporting code.	000 to 015.	003	----
051	ZONE 4 Reporting code.	255 = Disable Reporting	003	----
052	ZONE 5 Reporting code.	000 to 015.	003	----
053	ZONE 6 Reporting code.	000 to 015.	003	----
054	ZONE 7 Reporting code.	000 to 015.	003	----
055	ZONE 8 Reporting code.	000 to 015.	001	----
056	Keypad FIRE Reporting code.	255 = Disable Reporting	001	----
057	Keypad AUX 1/POLICE Reporting code.	000 to 015.	002	----
058	Keypad AUX 2/MEDICAL Reporting code.	000 to 015.	255	----
059	Opening (Disarm) Reporting code. For System Restore/Exception Opening add 16 to the desired report code.	000 to 031.	255	----
060	Closing (Arming)) Reporting code.	000 to 015.	255	----
061	Closing w/shunts Reporting code.	000 to 015.	255	----
062	Cancel Reporting code.	255 = Disable Reporting	255	----
063	Zone Restore Reporting code.	000 to 015.	255	----
064	Fire Trouble Reporting code.	000 to 015.	255	----
065	Low Battery Reporting code.	000 to 015.	255	----
066	Automatic 24-Hour Test code.	000 to 015.	255	----
067	SYSTEM USE ONLY - DO NOT PROGRAM!		000	X X X
068 ⋮ 097	Telephone NUMBER 1 (30 digits) 255 = END of telephone number.	000 to 013.	255	----
098 ⋮ 127	Telephone NUMBER 2 (30 digits). 255 = END of telephone number.	000 to 013.	255	----

APPENDIX B

Z1100 ZONE PLANNING GUIDE

ZONE TYPE	DEFINITION	VALUE	ZONE 1	ZONE 2	ZONE 3	ZONE 4	ZONE 5	ZONE 6	ZONE 7	ZONE 8
BURGLAR LOOPS	INSTANT	= 1								
	ENTRY DELAY 1	= 0								
	ENTRY DELAY 2	= 8								
	PERIMETER	= 0								
	INTERIOR	= 16								
	LOCKOUT AFTER	YES = 32								
	SINGLE ALARM	NO = 0								
	DAY ALERT	YES = 128								
		NO = 0								
FIRE		= 2								
POLICE/AUX 1	AUDIBLE	= 3								
	SILENT	= 11								
	KEYPAD									
MEDICAL/AUX 2		= 4								
KEY SWITCH	Only 1 Key Zone per system	= 5								

LOOP RESPONSE	FAST LOOP	= 0								
	SLOW LOOP	= 64								
TOTAL PROGRAM VALUE =										

↓ ↓ ↓ ↓ ↓ ↓ ↓ ↓

MEMORY ADDRESS FOR ENTERING TOTALS	022	023	024	025	026	027	028	029
------------------------------------	-----	-----	-----	-----	-----	-----	-----	-----

1. Plan each zone individually.
2. Select zone type from left column.
3. Using definition column, select characteristics for each zone type and enter appropriate value in the block under zone number for which you are programming.
4. Add vertically the total values for each zone and place in total block.
5. When programming the control, enter total value of each zone into the memory address location designated under each zone column.

QUICK TERMINAL REFERENCE GUIDE

TERMINAL	FUNCTION	DESCRIPTION					
1	Zone 1	<p>Each loop requires a 2200 Ohm end-of-line resistor. Normally closed and normally open devices may be connected within each loop. If an ordinary closed loop is desired, a jumper for each loop may be cut to eliminate the end-of-line resistor. A common loop return is shared between each group of two (2) zones.</p>					
2	COMMON						
3	Zone 2						
4	Zone 3						
5	COMMON						
6	Zone 4						
7	Zone 5						
8	COMMON						
9	Zone 6						
10	Zone 7						
11	COMMON						
12	Zone 8						
13 (-)	Remote Power (Negative)	Connect BLACK wire from Z1100R Keypad.					
14 (+)	Remote Power (Positive)	Connect RED wire from Z1100R Keypad.					
15	Data In	Connect GREEN wire from Z1100R Keypad.					
16	Data Out	Connect WHITE wire from Z1100R Keypad.					
17	AC Input	18 VAC 35VA transformer input.					
18	AC Input						
19	Earth Ground	Connect to a dedicated metal stake ground for best results.					
20 NO	Relay K1	Relay K1 may be utilized for switching power for sirens, strobes, lamps etc. Relay K1 may be triggered from a 12v positive source such as the J-16 outputs.					
21 COM							
22 NC							
23 (+) Trig							
24 NO	Relay K2	Relay K2 may be utilized for switching power for sirens, strobes, lamps etc. Relay K2 may be triggered from a 12v positive source such as the J-16 outputs.					
25 COM							
26 NC							
27 (+) Trig							
28 (-)	Common (Negative)	Common power supply negative.					
29 (+)	Aux. Power (Positive)	12 volts DC power for motion detectors and other accessories. This output is fused at 2.5 amps. Maximum continuous current drain from 14, 29, 30, 31 and connector J-16 outputs should not exceed 900 milliamps. Combined alarm condition current drain should not exceed 2.5 amps.					
30 (+)	Fire Power (Positive)	12 volts DC power for auxiliary fire annunciation devices. This output fused at 2.5 amps.					
31 (+)	Smoke Power (Positive)	Switched 12 volts DC power for powering smoke detectors. Command 7 from the keypad will temporarily remove power from this terminal for resetting smoke detectors.					
32 (TIP)	TELCO	<table style="border: none;"> <tr> <td style="border: none;">GREEN wire from RJ31X Telephone cord.</td> <td rowspan="4" style="border: none; vertical-align: middle;">} TC-3 Cord</td> </tr> <tr> <td style="border: none;">RED wire from RJ31X Telephone cord.</td> </tr> <tr> <td style="border: none;">BROWN wire from RJ31X Telephone cord.</td> </tr> <tr> <td style="border: none;">GRAY wire from RJ31X Telephone cord.</td> </tr> </table>	GREEN wire from RJ31X Telephone cord.	} TC-3 Cord	RED wire from RJ31X Telephone cord.	BROWN wire from RJ31X Telephone cord.	GRAY wire from RJ31X Telephone cord.
GREEN wire from RJ31X Telephone cord.	} TC-3 Cord						
RED wire from RJ31X Telephone cord.							
BROWN wire from RJ31X Telephone cord.							
GRAY wire from RJ31X Telephone cord.							
33 (RING)	TELCO						
34 (T1)	HOUSE						
35 (R1)	HOUSE						

GLOSSARY

Acknowledge. Respond to an alarm condition by entering an AUTHORIZATION code.

Address programming. This level of programming is used for custom designing the Z1100 system. For example, enter 005 into Address 022 to define Zone 1 as a mechanical key zone.

Authorization code. A programmable code that is used with a Command. For example, Command 1 and an Authorization code arms/disarms the Z1100 system. Authorization codes must be preceded by a Command Key.

Command. Instruction. Tell the system to perform a function.

Command key. A single keypad digit (0-9) pressed before an Authorization code.

Configuration digit. The first programmed digit of any code. This digit is used only by the Z1100 system, not by the end user.

Default. Pre set values. The Z1100 system comes with default exit time, entrance times, cutoff times, zone definitions, and other features. The default program makes installation and testing easier.

Disabled. Turn off. Not active.

Dynamic load test. Active test. The Z1100 battery is dynamically tested. A load is placed across the battery for 5 seconds and the battery voltage is measured.

EEPROM. Special type of "non-volatile" memory chip used in the Z1100 system. EEPROMs retain programmed information without backup power.

Enabled. Turned on. Activated.

Enter. To press a keypad key for entry of information.

Fail safe Arming. All Burglar zones must be secure (or shunted) before the system will Arm.

Loop response time. The amount of time (in milliseconds) that a zone has to remain violated in order to cause an alarm.

Program code. The code used with Command 9 to program features of the Z1100 system.

Prompt. Cue. The Z1100R keypad beeps after each programming step. These beeps are a "prompt", or instruction, to continue with the next step.

Trigger. A low current signal. Connector J-16 outputs can be used to trigger relay K1 or relay K2.

User programming. This level of programming is used to set Authorization codes, the Program code as well as Entrance times and the Communicator test time offset.

Watchdog. A circuit in the Z1100 system that prevents micro-processor latch up. The watchdog minimizes the harmful effects of lightning and high voltage transients.

Zone Definitions. How a zone responds. Zones can be burglar, fire, police, medical, or key.

FCC COMPLIANCE

PART 68 NOTIFICATION

This equipment complies with Part 68 of the Federal Communications Commissions (FCC) rules. All connections to the telephone network must be made through standard telephone company plugs and jacks, RJ31-X or equivalent, in such a manner as to allow for easy and immediate disconnection of the equipment. If the connecting cord is unplugged from the jack, there shall be no interference to the telephone equipment still connected to the telephone network.

The FCC registration number and Ringer Equivalence Number (REN) can be found printed on the wiring connection label located inside the Control Box Enclosure. If requested, provide this information to your telephone company. The REN is useful to determine the quantity of devices that may be connected to your telephone line and still have all of those devices ring when your number is called. In most, but not all, areas, the sum of the RENs of all devices should not exceed five.

In the unlikely event that the equipment should ever fail to operate properly, it should be disconnected from the telephone jack to determine if the problem is with the telephone network or with the equipment. If a problem is found with the equipment, leave it disconnected until it is repaired or replaced.

In the unlikely event that the equipment should ever cause harm to the telephone network, the telephone company may temporarily discontinue your service. If possible, they will notify you in advance. However, if advance notice isn't practical, the telephone company may temporarily discontinue service without prior notification. In the case of temporary discontinuance, the telephone company shall promptly notify the telephone subscriber who will be given the opportunity to correct the situation. The customer also has the right to bring a complaint to the FCC if he feels the disconnection is not warranted.

Your telephone company may make changes in its facilities, equipment, operations, or procedures that could affect the proper operation of your equipment. If they do, you will be given advance notice so as to give you an opportunity to maintain uninterrupted service.

You should notify the telephone company if this equipment is removed from the premises and the telephone jack is no longer needed.

The FCC prohibits the connection of this equipment to party lines and the use of this equipment in conjunction with coin-operated telephone service.

An AC surge arrestor should be installed in the system's AC power outlet.

PART 15 NOTIFICATION

This equipment has been tested and found to comply with the limits for a Class B digital device, pursuant to Part 15 of the FCC rules. These limits are designed to provide reasonable protection against harmful interference when the equipment is operated in a residential environment. This equipment generates, uses, and can radiate radio frequency energy and, if not installed and used in accordance with the instruction manual, may cause harmful interference to radio communications. However, there is no guarantee that interference will not occur in a particular installation. If this equipment does cause harmful interference to radio or television reception, which can be determined by turning the equipment off and on, the user is encouraged to try to correct the interference by one or more of the following measures:

- Reorient or relocate the receiving antenna.
- Increase the separation between the equipment and the receiver.
- Connect the equipment into an outlet on a circuit different from that to which the receiver is connected.
- Consult the dealer or an experienced radio/TV technician for help.

CAUTION: Changes or modifications not expressly approved by the manufacturer could void the user's authority to operate the equipment.

Z1100R FLUSH-MOUNT TEMPLATE

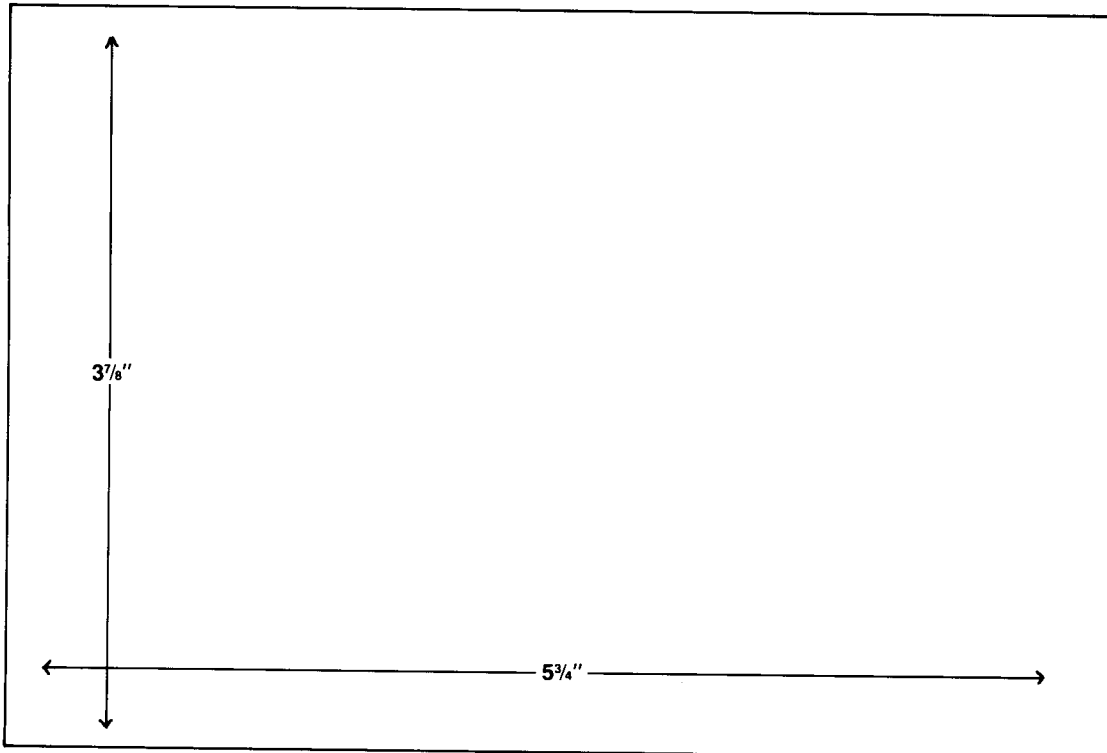

1. Cut Hole $3\frac{7}{8}$ " x $5\frac{3}{4}$ ".
2. Assemble hardware as indicated on page 21.

MOOSE 

A PRODUCT OF SENTROL, INC

SENTROL CONTROLS GROUP

PO Box 2904

1510 Tate Blvd. SE

Hickory, NC 28603

Sales: 800.547.2556

Fax: 503.691.7566

Technical Support: 800.800.2027

Sentrol, Inc. reserves the right
to change specifications
without notice.

©1996 Sentrol, Inc.

64812666B