

ADEMCO

SECURITY CENTER

Protection System

4180

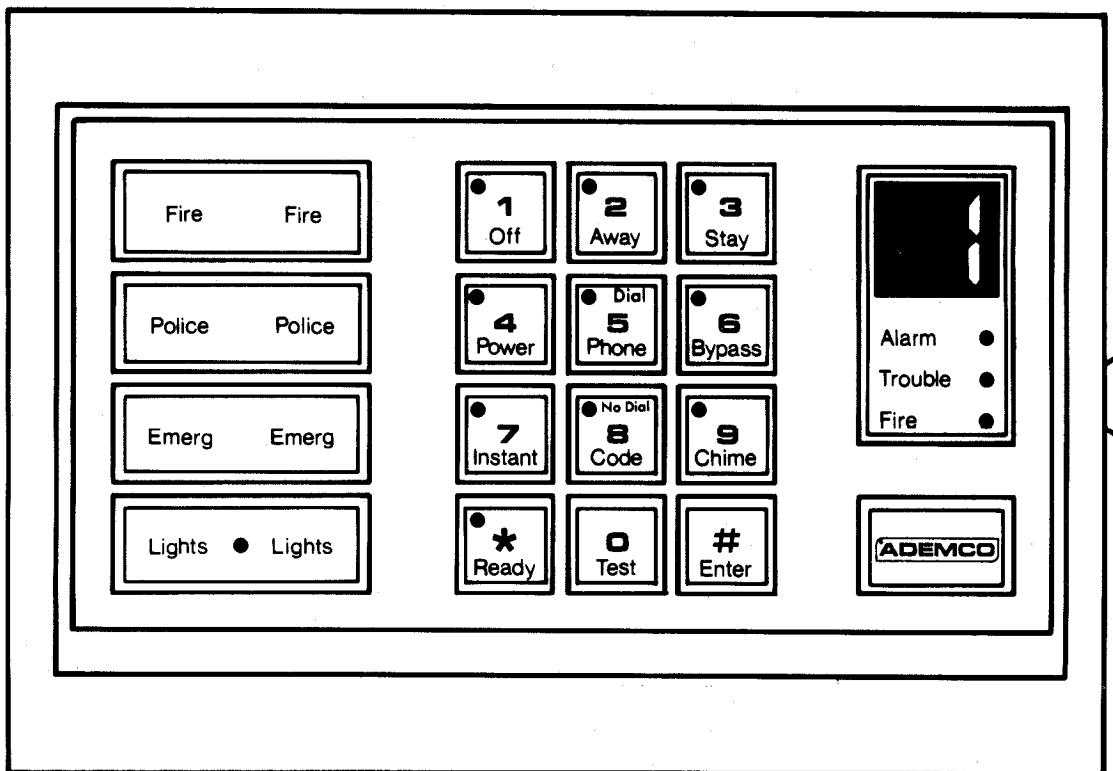

USER'S MANUAL

INTRODUCTION

Congratulations on your ownership of the SECURITY CENTER. You've made a wise decision in choosing it, for it ranks among the best security protection available today.

Basically, SECURITY CENTER offers you three forms of protection: burglary, fire and emergency. To realize the system's full potential, it is important that you feel comfortable in operating it.

This manual is a step-by step guide that will fully acquaint you with SECURITY CENTER's features and benefits. It defines the components and their functions, describes their operation, and acquaints you with normal and emergency procedures.

The following glossary of terms used throughout the manual will avoid any confusion.

GLOSSARY

ARM/DISARM:

"Armed" simply means that the burglary portion of your system is turned ON, and is in a state of readiness. "Disarmed" means that the burglary system is turned OFF, and must be rearmed to become operational. However, even in the "disarmed" state, "emergency" and "fire" portions of your system will still be operational.

KEYPAD:

This is the area on your master console, or any remote unit, containing numbered pushbuttons similar to those on telephones or calculators. These keys control the arming or disarming of the system, and perform other functions which will be described.

ZONE:

A specific area of burglary protection.

BYPASS:

To disarm a specific area of burglary protection while leaving other areas operational.

DELAY ZONE:

An area of protection containing doors most frequently used to enter or exit (typically, a front door, back door, or door from the garage into the house). The delay zone allows sufficient time for authorized entry or exit without activating the alarm.

TABLE OF CONTENTS

System's Major Components	2-3
Functions of Master Console	4-5
Functions of Optional Remote Keypad	5
Key to Audible Signals	6
Burglary Protection	7-9
Fire Protection	10
National Fire Protection Association Recommendations on Smoke Detectors	11
Emergency Evacuation	12
Your Own Evacuation Plan	13
Emergency Action	14
Chime Annunciation	15
Remote Control of Your System	15
Testing/ Servicing Procedures	16-18
Federal Communications Commission Statement	19
Questions and Answers About Your Security System	20-21
Warning. The Limitations of This Alarm System	22
Owner's Insurance Premium Credit Request	23-24
Limited Warranty	25
Emergency Phone Numbers	26

SYSTEM'S MAJOR COMPONENTS

Your system consists of the Control/Communicator, one or two Master Consoles and up to four optional Remote Keypads.

THE CONTROL/COMMUNICATOR

The Control/Communicator is the "brains" of your system. Located out of sight, it receives signals, analyzes them, initiates alarms and transmits alarm messages to your police department or to a central alarm monitoring service.

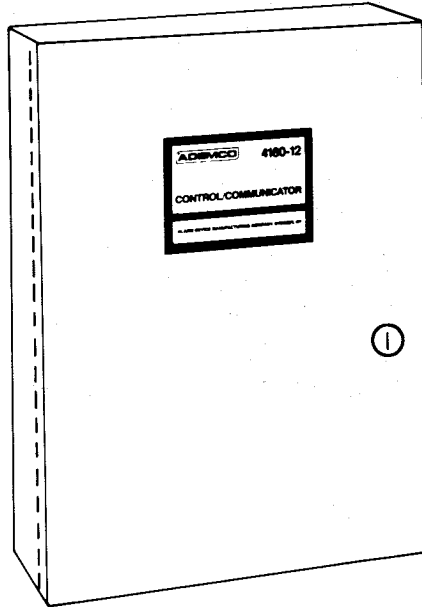

THE MASTER CONSOLE

The Master Console is centrally located to suit your convenience. Its individual indicator lights display messages that inform you of the status of your system. The console enables you to arm or disarm the burglary portion of your system, and is also the source of alarm and warning sounds.

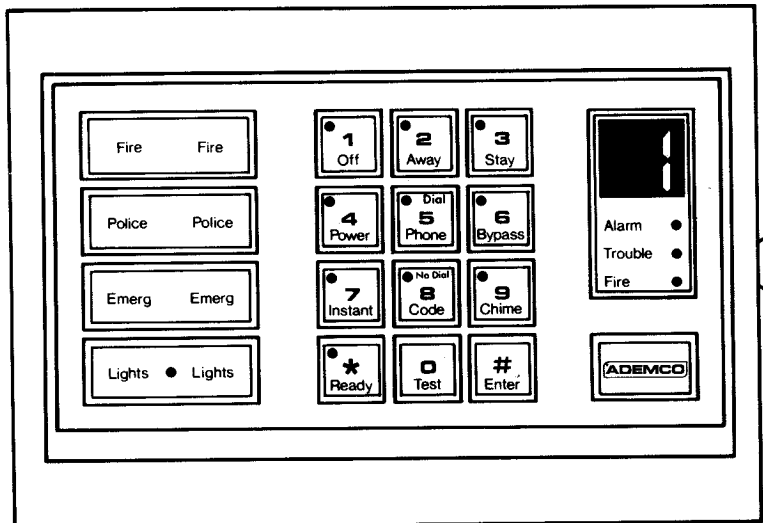

THE REMOTE KEY PAD

The Remote Keypad(s) are optional units providing additional locations from which you can arm or disarm your burglary system. Each Keypad has various indicator lights to inform you of the status of your system and is also the source of warning sounds.

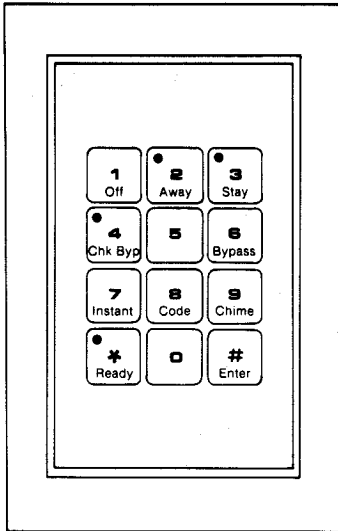

FUNCTIONS OF MASTER CONSOLE

Items B. thru D. describe various manual alarm functions. The appropriate indicator will light upon manual initiation of audible alarms. These will also light for alarms triggered by smoke detectors and remote panic buttons.

Audible alarms sound both inside and outside. In each instance, the interior siren sound described is similar to the outside sound unless a bell has been selected for the exterior.

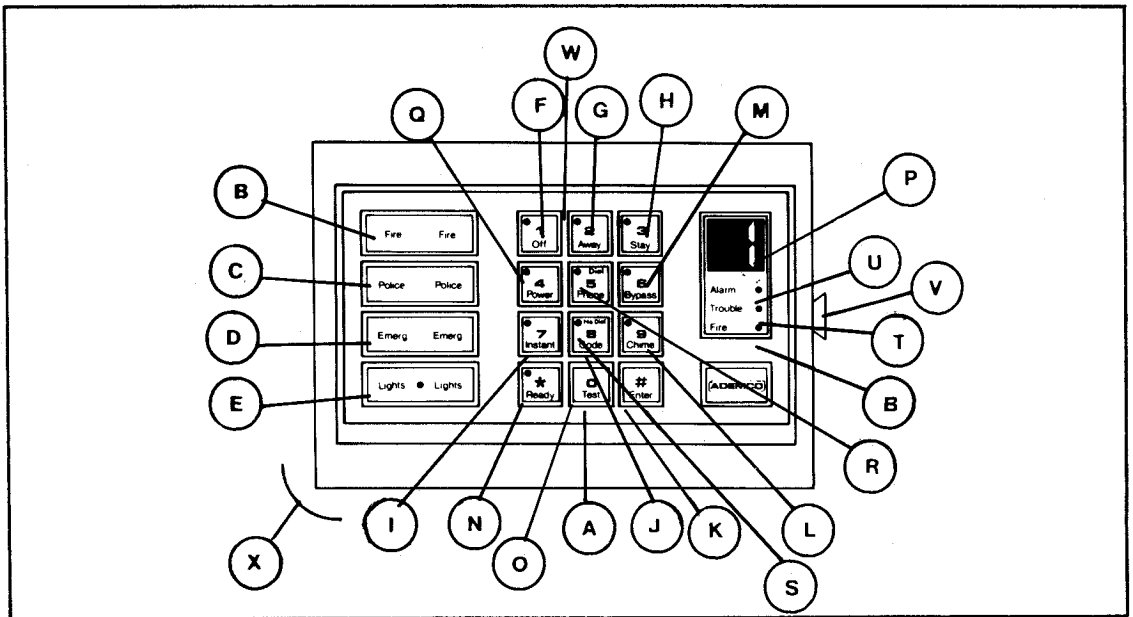

NOTE: Only active if programmed for described operation at installation time.

- A.** KEYS 0-9 are used to enter your individual four-digit Security Code.
- B.** FIRE/FIRE KEYS & INDICATOR LIGHT. Simultaneous depression of both keys sounds a FIRE alarm; a loud, pulsating rapid two-tone siren (Optional) or outside bell (Pulsating ringing sound.)
- C.** POLICE/POLICE KEYS. Depending on configuration determined at time of system installation, simultaneous depression of both keys will trigger either a silent POLICE alarm (if connected to a police agency or central alarm monitoring service) or an audible POLICE alarm; a loud, rapid two-tone siren (Optional) or outside bell (Steady ringing sound).
- D.** EMERG/EMERG KEYS. Depending upon configuration determined at time of system installation, simultaneous depression of both keys will trigger either a silent EMERG alarm (if connected to a police agency or central alarm monitoring service) or an audible EMERG alarm; a loud, rapid two-tone siren (Optional) or outside bell (Steady ringing sound).
- E.** LITES ON KEYS & INDICATOR LIGHT. Simultaneous depression of both keys causes selected lights in your place to be turned on remotely.

NOTE: To turn off alarm sounding or lights after activation of one of the above functions, enter your code and depress the OFF key.

To accomplish Functions F thru J, L, M or O, you must enter your Security code BEFORE depressing the designated key(s).

- F.** OFF KEY & INDICATOR LIGHT. Disarms the burglary portion of your security system, silences any alarms in progress, trouble, alarm memory, loss of AC sounding and clears any lighted alarm indicators. (Code + OFF) The Green indicator lights to indicate that the burglary protection is turned off.
- G.** AWAY KEY & INDICATOR LIGHT. Completely arms the burglary portion of your system. The Red indicator lights to confirm successful arming of the AWAY function, and stays lit as long as the system remains in this mode. (Code + AWAY)
- H.** STAY KEY & INDICATOR LIGHT. Arms the burglary portion of your system with the exception of the interior zone(s) of protection. The Red indicator confirms successful arming using the STAY function, and stays lit as long as this mode prevails. (Code + STAY)
- I.** INSTANT KEY & INDICATOR LIGHT. (Primarily for use when the occupants are in to stay.) Depress after pressing either the STAY or AWAY keys, and this key eliminates the entry delay period, causing an instant intrusion alarm should someone come through a main door. The Yellow indicator will light as a reminder that the Delay Zone is now an Instant Zone. [Code + AWAY (or STAY) + INSTANT]
- J.** CODE KEY. Depressing this key allows the immediate entry of a new temporary four-digit Security Code that can be given to those who require interim access to your place. (Code + CODE + Code Designator [2 → 8] + Temporary Code).
- K.** ENTER KEY. Depress after pressing one of the other mode or function keys and this optional usage key terminates the two-second interval normally allotted to mode entries, so that the desired function can be executed immediately (rather than two seconds later).

- L. CHIME KEY & INDICATOR LIGHT.** In disarmed (OFF) state, enter Code, then depress key to set CHIME mode. Any opening of a sensor in selected chime zones will produce a short tone from the speaker(s) at any console(s), thereby signaling an entry (Code + CHIME). The Yellow indicator lights when the CHIME mode is on.
- M. BYPASS KEY & INDICATOR LIGHT. 1. Arming in the Presence of a Fault.** Depress either the AWAY or STAY keys, then the BYPASS KEY. This turns off protection monitoring from any currently violated burglary zones (e.g., an improperly-functioning sensor that is preventing the arming of the system, or an intentionally violated sensor that likewise inhibits the arming of the rest of the system). The Yellow indicator light will light to reveal that your burglary protection is incomplete because the monitoring of one or more protective sensors has been temporarily discontinued. [Code + AWAY (or STAY) + BYPASS]. **2. Individually Bypassing Particular Zone(s).** Depress the BYPASS Key and then the number of the zone to be bypassed. The Yellow Indicator function is as described (Code + BYPASS + "N"). See Zone Identification Display.
- NOTE:** Only applicable to those zones enabled for bypass function at installation time.
- N. READY KEY & INDICATOR LIGHT.** The Green indicator reveals the status of your burglary protection. If lit, your burglary protection is turned off and all sensors are closed/ready for arming. If not lit (and neither the STAY nor AWAY indicators are lit) your burglary system is turned off/not ready for arming. (In this event, do not arm your system. See "How to Remedy a Malfunction in a Specific Zone," page 18.) Normally, the one-digit numeric display will not indicate which zones are violated except when an attempt is made to arm the system. To view the individual zone's status at other times, press the READY key. The zone status display can be turned off by entering your Security Code and then the OFF key.
- O. TEST KEY.** Causes execution of the fire test function and permits entry to the system test mode, both described in TESTING AND SERVICING PROCEDURES:(code + TEST).
- P. ZONE IDENTIFICATION DISPLAY.** This one-digit numeric display identifies violated burglary zones (1-8) at arming time or subsequent to an alarm for determination of entry point. This display also provides a sequential viewing of zones bypassed as described in the sections for INDIVIDUAL ZONE BYPASS and HOW TO REMEDY A
- MALFUNCTION IN A SPECIFIC ZONE.** If your system is equipped with optional zone expander(s) (adding more zones to the system) a violation in one or more zones located in those expansion units will be indicated by "0" on this display (go to the zone expander to determine which of its zones was violated). If the system is equipped with an optional device to detect if the telephone line connected to your system is intact, an interruption of that line will cause an "F" to be displayed.
- Q. POWER INDICATOR LIGHT (Green).** Indicates the presence of AC power.
- R. "DIAL" INDICATOR LIGHT (Red).** Lights when an audible alarm, trouble, or other message is being transmitted to a central alarm monitoring service. Flashes for 30 seconds after successful receipt of the message is acknowledged.
- S. "NO DIAL" INDICATOR LIGHT (Red).** Lights when the system has a message to transmit to a central monitoring service and is unable to get that message through after repeated attempts. It remains lit until the system is next armed.
- T. TROUBLE INDICATOR LIGHT (Red).** Lights when Fire or Day/Night Burglary Zones (determined at installation time) are open during disarmed period if Day/Night Burglary and at any time if Fire.
- U. ALARM INDICATOR LIGHT (Red).** Lights when an intrusion has been detected during the armed period or an audible emergency is activated. It remains lit after the alarm sounder has silenced, as a warning upon your return.
- V. PULL-OUT DRAWER.** Contains numbered zone identification information (so that a number displayed on the Master Console can be quickly translated into the Zone I.D.) and brief user instructions.
- W. KEYPAD ILLUMINATION LIGHT.** Lights for convenient use of the Master Console in a darkened room.
- X. INTERNAL SPEAKER.** Source of audible internal warning and confirmation sounds, as well as alarms.

FUNCTIONS OF OPTIONAL REMOTE KEYPAD

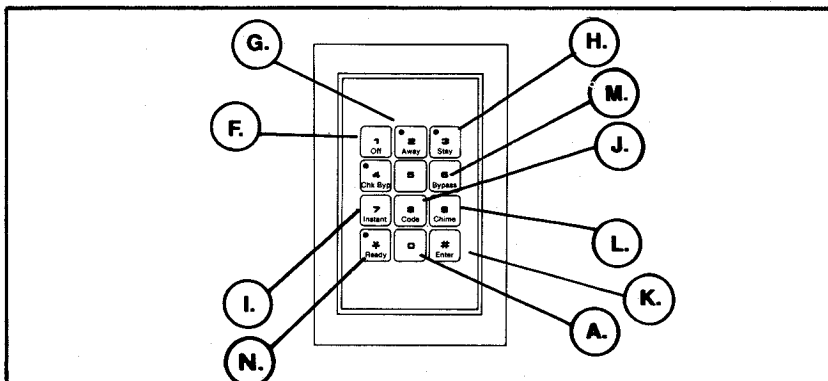

READY—Green (Same meaning as above)

CHK. BYP—Yellow: Steady—Zone Bypassed, Flashing—Trouble in Fire or Day/Night Burglary Zone. A buzzer serves as a source of audible internal warning and confirmation sounds, as well as alarms.

Functions A and F thru N (as described above) can be performed at the remote Keypad(s) via the same procedures as at the Master Console. However, rather than the indicator lights described, the remote Keypads contain only four indicator lights.

AWAY—Red (Same meaning as above plus it flashes for memory of previous alarm)

STAY—Red (Same meaning as above plus it flashes for memory of previous alarm)

KEY TO AUDIBLE SIGNALS

INTERNAL SPEAKER SOUND	EXTERIOR SOUND (IF USED)	CAUSE	DISPLAY(S) PRESENT
LOUD, INTERRUPTED, RAPIDLY PULSATING SIREN SOUND*	INTERRUPTED, RAPIDLY PULSATING SIREN SOUND OR PULSING BELL RING	FIRE ALARM	"FIRE" indicator lit. The number of the zone in alarm will be displayed (i.e., 1 through 8)
LOUD, RAPIDLY PULSATING SIREN SOUND*	RAPIDLY PULSATING SIREN SOUND OR STEADY BELL RING	BURGLARY/AUDIBLE POLICE/EMERGENCY ALARM	"ALARM" indicator lit. The number of the zone in alarm will be displayed (i.e., 0 through 8, F)
ONE SHORT BEEP, NOT REPEATED.	NONE	SYSTEM WAS TURNED OFF OR AN ATTEMPT WAS MADE TO ARM THE SYSTEM WHEN ONE OR MORE SENSORS WERE FAULTED.	GREEN "READY" indicator may or may not be lit. GREEN "OFF" indicator lit.
TWO SHORT BEEPS	NONE	SYSTEM HAS JUST BEEN ARMED IN THE "AWAY" MODE.	RED "AWAY" Indicator lit.
THREE SHORT BEEPS	NONE	SYSTEM HAS JUST BEEN ARMED IN THE "STAY" MODE	RED "STAY" Indicator lit.
ONE LONG BEEP	NONE	SYSTEM IS DISARMED AND IN THE CHIME MODE AND A SENSOR IN A CHIME ENABLED ZONE HAS JUST BEEN ACTIVATED.	The number of the zone is displayed if READY button has been depressed.
RAPIDLY PULSING BEEPS*	NONE	<ol style="list-style-type: none"> 1. A PROBLEM IN A FIRE ZONE (IF USED) AT ANY TIME OR IN DAY/NIGHT BURGLARY ZONE (IF USED) WHEN DISARMED. 2. AC POWER HAS BEEN LOST FOR MORE THAN AN INSTALLER PROGRAMMED INTERVAL (0-36 minutes) 3. A MEMORY OF ALARM THAT IS ACTIVATED DURING ENTRY 4. TELEPHONE LINE TO SYSTEM HAS BEEN INTERRUPTED WHEN DISARMED (IF DETECTION CAPABILITY INSTALLED) 	<p>"TROUBLE" indicator lit plus the number of the zone having the problem.</p> <p>GREEN "POWER" indicator not lit.</p> <p>"ALARM" or "FIRE" indicator lit plus the number of the zone that caused the alarm.</p> <p>"F" displayed on the Zone Identification Display.</p>
ONE SHORT BEEP, REPEATED EVERY 15 SECONDS	BRIEF SOUND WHEN ZONE IS TESTED	SYSTEM IS IN THE "TEST" MODE	Zone number displayed when zone is tested.
ONE OR MULTIPLE SHORT BEEPS, NOT REPEATED	NONE	ZONE(S) HAVE JUST BEEN BYPASSED OR A DISPLAY OF PREVIOUSLY BYPASSED ZONES IS REQUESTED	"BYPASS" indicator lit and the number(s) of the Zone(s) that have been bypassed are displayed.
CONTINUOUS LOW TONE**	NONE	PROLONGED AC POWER OUTAGE HAS RESULTED IN SYSTEM SHUTDOWN. SYSTEM INOPERATIVE.	GREEN "POWER" indicator not lit. "C" appears in ZONE ID display area.

*Any pulsating tone (beeps) or alarm sounds from the Console will be immediately silenced when the first digit of your security code is keyed (any alarms from external sounders will continue, however). This will allow the confirmation (feedback) tone emitted by the Console to be heard as each key on the keypad is depressed. If the entire security code, plus OFF, are not keyed within 10 seconds, the pulsating tones or alarm sounds will resume at the Console.

**The continuous tone can be silenced by depressing the "4" key, but note that until AC power is restored and the built-in battery sufficiently charged, the System will be incapable of sounding and communicating alarms. After a sustained AC power outage, the battery may require a recovery period of up to 24 hours before the System is again fully operative.

BURGLARY PROTECTION

HOW TO ARM YOUR BURGLARY SYSTEM

Your system provides two levels of burglary protection, exterior and interior. The former guards doors, windows, etc., sounding an alarm if one is opened by an intruder. Interior protection offers backup defense, sensing when an unauthorized person is moving inside.

FOUR-DIGIT SECURITY ACCESS CODES

At the time of installation, you choose a personal four-digit code, known only to you and yours, and programmed by your installer. ARMING and DISARMING of your burglary alarm system is accomplished by entering this code and the desired function (e.g. STAY, AWAY, etc.) at the Master Console and at any Remote Keypad.

NOTE: If more than 2 seconds elapse after a keystroke, the security access code and function must be re-entered.



As an additional safety feature, up to 7 secondary (temporary) codes may be utilized at any time for designated users 2 through 8. An employee who, in your absence, must arm the system upon departure, can be provided with a different temporary code that allows arming and disarming and all other system functions except assigning or changing codes (the secondary code for user 2 can additionally assign or change codes for users 3 through 8).

NOTE: Your master code remains in effect even when a secondary code is present (unless an option has been selected with your installer at installation time which will inhibit the master code's use once a secondary code for user 2 has been selected and entered by you. With that option selected, user 2's code must be the first secondary code entered. Once entered it cannot be changed without assistance from your service company).

A secondary code can be entered, or changed, at the Master Console or at any Remote Keypad, as follows: Enter the master code (or user 2's code, if it is in effect), depress the CODE key, then key in the code designator (2 through 8 or, with user 2's code, 3 through 8) and the desired temporary secondary code. To eliminate a secondary code, repeat this sequence, keying-in another code as a secondary code (not the master code).

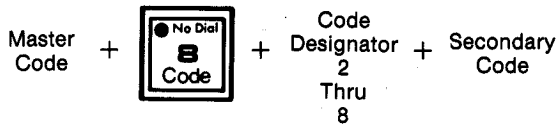

Or

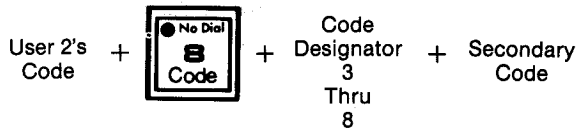

INDIVIDUAL ZONE BYPASS

There may be times when it is desired to leave doors (for access), windows (for ventilation) or parts of your system unprotected intentionally. This may be accomplished by selectively bypassing one or more zones of protection. PRIOR to (or AFTER) arming.

1. At your Master Console, enter your security code and depress the BYPASS key followed by the number(s) of the zone(s) to be bypassed. The Yellow BYPASS Indicator Light will turn on here and at remote keypads (CHK-BYP). In addition, your console Zone Identification Display will sequentially show each zone bypassed, once, producing a single beep tone as each zone is displayed.

2. Check to see that the bypass is effective by depressing the READY key and by opening and closing sensors in the "bypassed" zones to see if the Green READY Light will turn off and if the Zone Identification Display indicates the number of the bypassed zone. If it does, the procedure of steps 1 and 2 should be repeated.

3. Arm the system using the procedures in the following sections if the BYPASS was performed prior to arming.

4. The zone BYPASS is automatically removed when the system is turned OFF.

NOTE: If it is desired to view a display of bypassed zones at any time, enter your security code and press the BYPASS key. The sequential display described above will be produced once.

IMPORTANT: Only those zones agreed upon with your installer at installation time can be bypassed using this procedure.

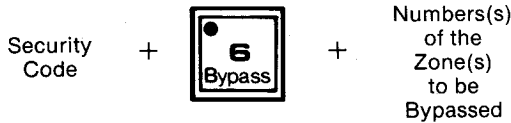

WHILE INSIDE

1. Check the Green READY Indicator Light on your Master Console or Remote Keypad. It should be on to indicate that your system is ready to be armed. Enter your security code and depress the STAY Key at your console. The Red STAY Indicator Light will illuminate and you will hear three tones from your Master Console and any Remote Keypads. You have now ARMED successfully with the ability to walk freely through the interior.

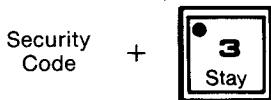

2. "Delay Off" Armings. If you wish the act of opening one of your main access doors to instantly trigger an alarm, do the following; Enter your security code. Depress the STAY Key and then the INSTANT Key. Both the Red STAY and the Yellow INSTANT Indicator Lights will illuminate and you will hear three tones from your Master Console and any Remote Keypad(s). Disarming automatically removes the "Delay Off" function.



NOTE: If the Green READY Indicator Light on your Master Console is not on, check the Zone Identification Display after depressing the READY Key or after attempting to arm the system. A number appearing there indicates a violated zone (and its location). The problem must be corrected before arming can take place. See "How To Remedy a Malfunction in a Specific Zone" on page 18.

WHEN LEAVING WITH NO ONE REMAINING

1. Check the Green READY Indicator Light on your Master Console. It should be on, indicating that the system is ready for arming.
2. Enter your security code and depress the AWAY Key. The Red AWAY Indicator Light will illuminate and you will hear two tones from your Master Console and any Remote Keypad(s) signifying that the system is ARMED. You have 15 to 135 seconds (programmed at time of installation, in 15 second increments) to leave through your chosen exit door before such passage will cause an alarm to sound.

Security Code +



HOW TO DISARM YOUR BURGLARY SYSTEM UPON ENTERING

1. Enter via a door in your Delay Zone. You will hear a slowly pulsating tone from your Master Console and any remote Keypad(s). Depending on the programming at time of installation, you have 15 to 135 seconds (programmed at time of installation in 15 second increments) to reach your Master Console or Remote Keypad and DISARM the burglary portion of your system.

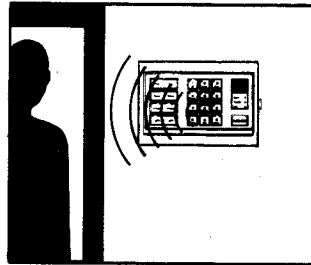

2. Enter your code and depress the OFF Key. The Red AWAY Indicator Light will go out and you will hear a single tone from your Master Console and any Remote Keypad(s). You may open and close doors and windows, and move freely inside, without setting off an alarm. The Green OFF Indicator Light will then be ON.

NOTE: Keying of the first digit of your security code will immediately silence any pulsating tones or alarm sounds that your Console may be emitting as you enter (any alarms from external sounders will continue, however). This will allow you to hear the confirmation tone emitted by the Console as each key on the keypad is depressed. If the entire security code, plus OFF, are not keyed within 10 seconds, the pulsating tones or alarm sounds will resume at the Console.

Security Code +



IMPORTANT

BEFORE keying your code, observe the ALARM Indicator on your Master Console. If it is lit, or if you hear a rapidly-pulsating tone from your Console, an intrusion has occurred during your absence. Leave immediately and contact the police from the nearest safe location.

WHILE INSIDE

1. Go directly to the nearest Console or Keypad, enter your code and depress the OFF Key. The Red STAY Indicator Light will go out and the Green OFF Indicator Light will go on, and you will hear a single tone from your Master Console and any Remote Keypad. You may now open and close doors and windows, and move freely inside without setting off an alarm.

Security Code +



NOTE: While the system is DISARMED, the Green READY Indicator Light will go on and off as various sensors are activated by your normal activities.

FIRE PROTECTION (IF INSTALLED)

OPERATION OF YOUR FIRE ALARM SYSTEM

Your fire alarm system is "ON" 24 hours a day, for continual protection. In the event of an emergency, the smoke and heat detectors strategically located throughout your home will automatically send signals to your Control/Communicator, triggering a loud, interrupted warbling siren sound from your Master Console. A similar sound will be produced by optional exterior speakers (unless bells are used). The Red FIRE Indicator Light at your Master Console will illuminate, and remain lit until you silence the alarm.

Should you become aware of a fire emergency before your detectors sense the problem, go to your nearest console. Manually initiate an alarm by depressing both FIRE Keys simultaneously.

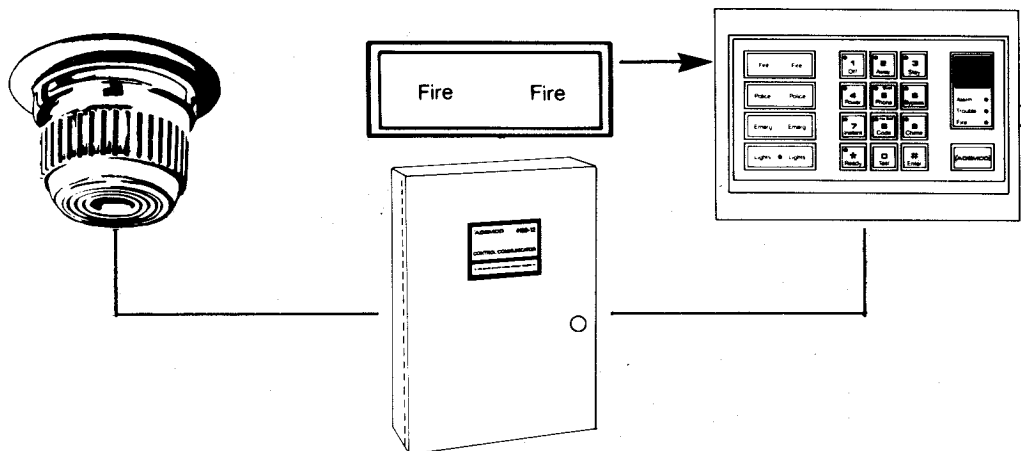

In any event, your first action should be to make sure that all occupants are safely evacuated. That done, if no flames or dense smoke are apparent, investigate the cause of the alarm.

1. Silence the alarm by entering your code and pressing the OFF Key.
2. If the alarm continues, check all detectors, to make sure they are not responding to smoke or heat-producing objects in their vicinity. Should this be the case, eliminate the source of heat or smoke.
3. If this does not remedy the problem, there may still be smoke in the detector. Clear it by fanning the detector for about 30 seconds.
4. When the problem has been corrected, repeat Step 1 to silence the alarm.

NOTE: It may be desired to bypass the fire zone during a period when it is known that smoke will be produced (e.g. deep fat frying or broiling) that could activate a smoke or products of combustion detector. Enter the security code and depress the BYPASS key followed by the number(s) of the fire zone(s) to be bypassed (only if allowed by programming at installation time). Subsequent entry of your security code and depression of OFF will cause the fire zone to be re-enabled for alarm detection.

Security Code

+

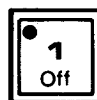

NATIONAL FIRE PROTECTION ASSN. RECOMMENDATIONS ON SMOKE DETECTORS

With regard to the number and placement of smoke and heat detectors, we subscribe to the recommendations contained in the National Fire Protection Association's Standard #74, noted below:

Smoke detectors shall be installed outside of each separate sleeping area in the immediate vicinity of the bedrooms and on each additional story of the family living unit, including basements and excluding crawl spaces and unfinished attics.

These provisions represent the minimum number of detectors required by this standard. It is recommended that the householder consider the use of additional smoke or heat detectors for increased protection for those areas separated by a door from the

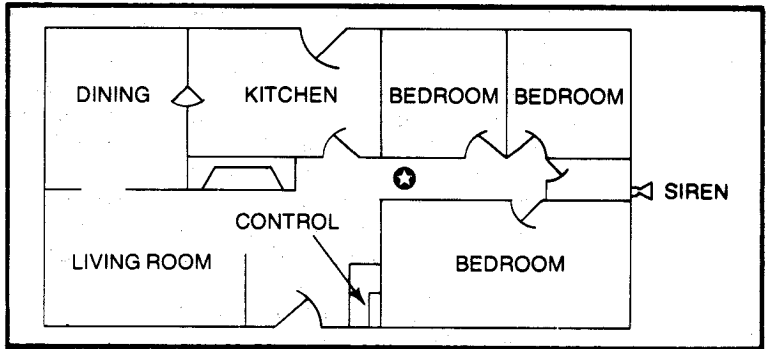

BEST RESIDENTIAL DETECTOR PLACEMENT: BETWEEN BEDROOMS and REST OF HOUSE

areas protected by the required smoke detectors. The recommended additional areas are: living room, dining room, bedroom(s), kitchen, attic (finished or unfinished), furnace room, utility room, basement, integral or attached garage and hallways. However, the use of the additional detectors remains the option of the householder.

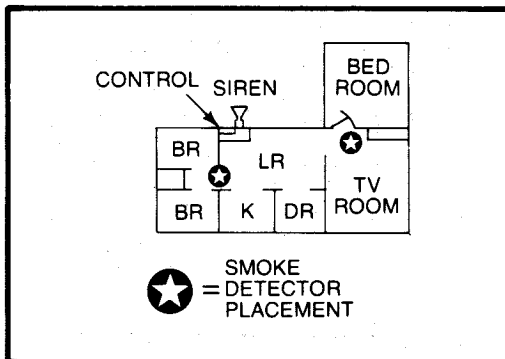

PLACE DETECTOR NEAR ALL SLEEPING AREAS

MAXIMUM FLOOR COVERAGE — DETECTORS AT TOP OF STAIRWELLS

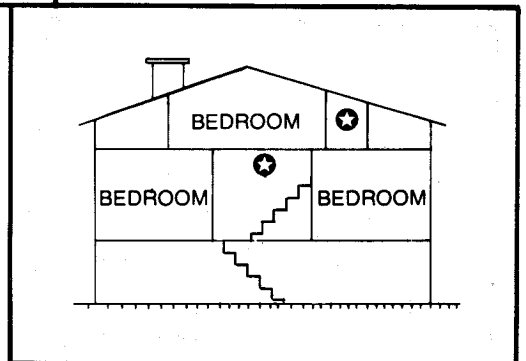

EMERGENCY EVACUATION

Every family should take steps to establish and regularly practice a plan of escape in the event of a fire. The following steps are recommended by the National Fire Protection Association and can be used as a guide in developing your own emergency plan.

1. Plan on your detector or your interior and/or exterior sounders waking the family.
2. Determine two means of escape from each room in your home, particularly the bedrooms, since most home fires occur at night when everyone is asleep. One path of escape should lead to the door that permits normal exit from the house. The other may be a window which opens easily to permit escape should your primary path be unpassable. It may be necessary to station an escape ladder at such windows if there is an unusually long drop to ground below.
3. Sketch a floor plan of your home. Show windows, doors, stairs and rooftops that can be used to escape in the event of fire. Indicate escape routes for each room. Remember to keep these routes free from obstruction and post copies of the escape route sketch in every room.
4. Make sure that all bedroom doors are shut while the family is asleep. This will prevent deadly smoke from entering while you escape.
5. Try the door. If it is hot, check your alternate escape route. If the door is cool, use your shoulder to open it cautiously. Be prepared to slam the door if smoke or heat rushes in.
6. Crawl in the smoke and hold your breath.
7. Escape quickly; don't panic.
8. Establish a common meeting place outdoors, away from your house where everyone can meet and then take steps to contact the authorities and account for those missing. Choose someone to assure that nobody returns to the house — many die going back.

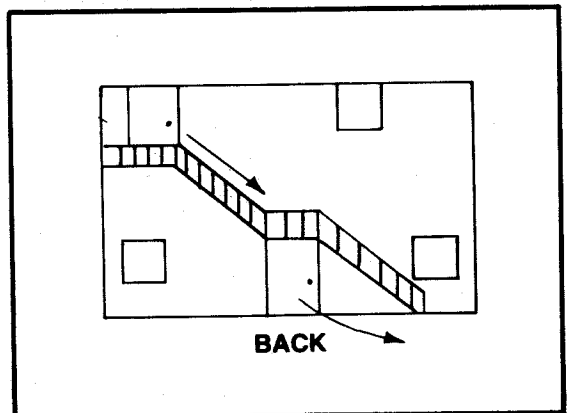
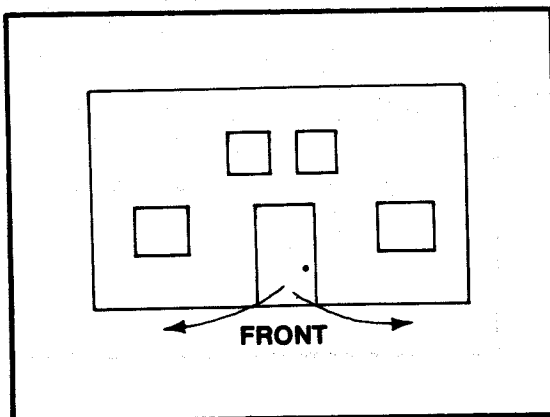
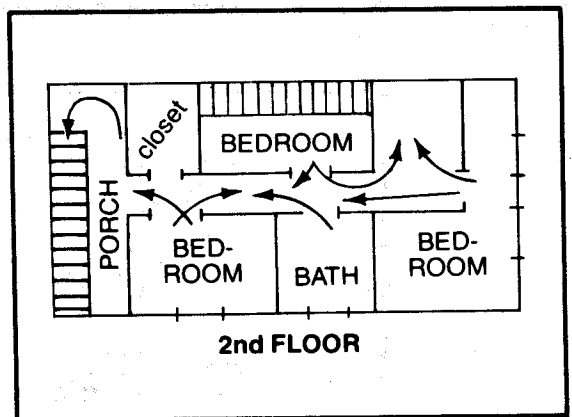
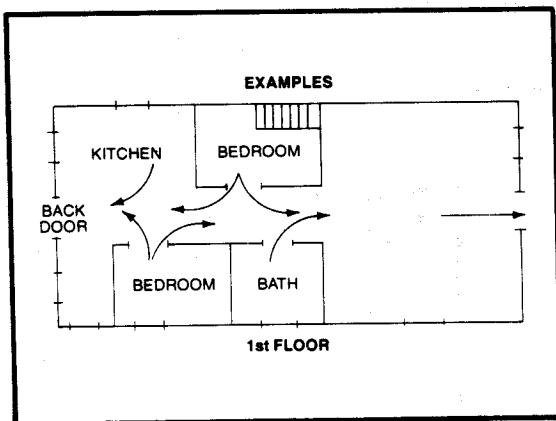

DRAW YOUR OWN EVACUATION PLAN

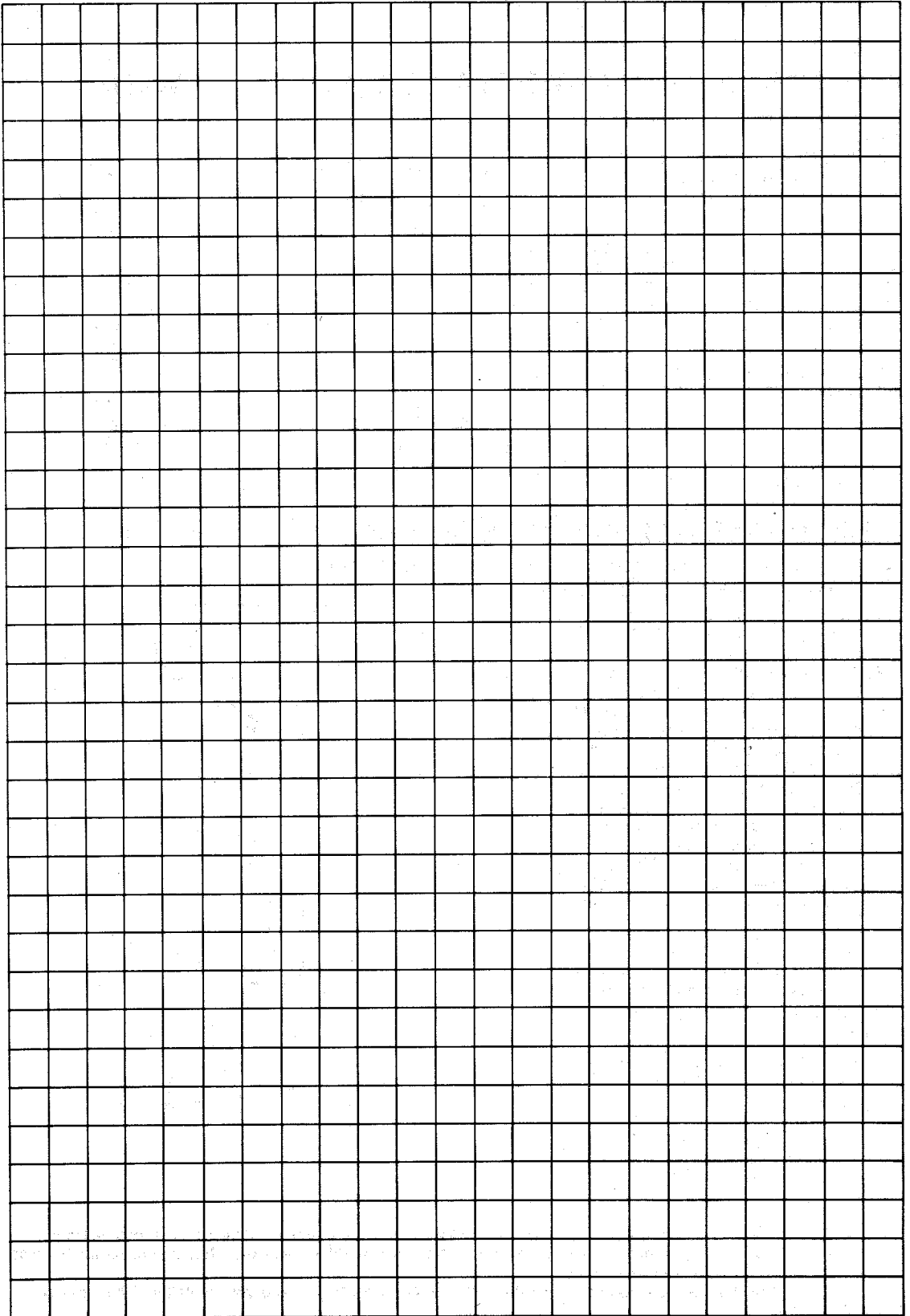

EMERGENCY ACTION

NOTE: The emergency portion of your system is always "ON", whether or not the burglary system is armed. This line of defense allows you to sound a loud panic alarm (or to send a silent emergency signal to appropriate agencies, if such provisions have been made).

HOW TO SOUND AN AUDIBLE PANIC ALARM (IF INSTALLED)

1. To trigger the alarm, you have two options:

- A. Simultaneously depress both EMERG Keys on any console.
- B. Press any remote emergency switch.

2. In either case, a loud, rapidly pulsating siren will sound at your Master Console. Your exterior siren or bell will sound. The Red ALARM Indicator Light on your Master Console will illuminate.

3. To reset, enter your security code and depress the OFF Key at the Master Console or nearest Remote Keypad.

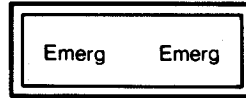

OR

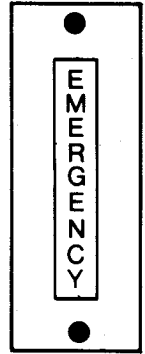

Security Code

+



HOW TO SEND A SILENT EMERGENCY ALARM (IF INSTALLED)

NOTE: Usage of this feature is relevant only if connected to a local police department or alarm monitoring service.

1. You have three options:

- A. Simultaneously press both POLICE Keys on any Console.
- B. Press any Silent Emergency switch.
- C. Enter your Duress Code to disarm the system. The latter is your normal master or temporary access code with the addition of one to the fourth code digit (e.g. If normal code is 1-2-3-4, the Duress code is 1-2-3-5). If the code is keyed with this special last digit, normal system disarming takes place plus the action of the next step. This code could be used if you were hostage to an intruder and were directed to disarm your system.

2. Your system's Silent Emergency communication equipment will activate immediately, but no siren or bell will sound. The Red ALARM and DIAL Indicator lights on your Master Console will not illuminate.

3. To turn off your Silent Emergency alarm, enter your security code and press the OFF Key at the nearest console.

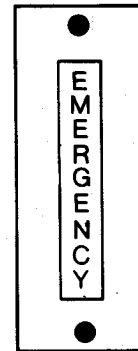
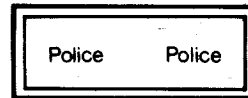

Security Code

+



NOTE: If an emergency button is locked in, the system may not subsequently arm even if the READY light is on.

NOTE:

The two EMERG keys and the two POLICE keys only function to activate a panic alarm if your installer has configured zones of your system for use as panic zones to be activated by these keys. If zones have not been so configured, these keys are non-functional.

Whether or not these alarms are audible or silent is determined between you and your installer at the time of system installation.

CHIME ANNUNCIATION

Your system is capable of alerting you to the opening of a door or window during the DISARMED state. To use this feature:

1. Enter your security code, then press the CHIME Key.
2. Should a door or window open, a single tone will sound from the Master Console.
3. To turn off this feature, again enter your security code and press the CHIME Key.

Security
Code

+



REMOTE CONTROL OF YOUR SYSTEM

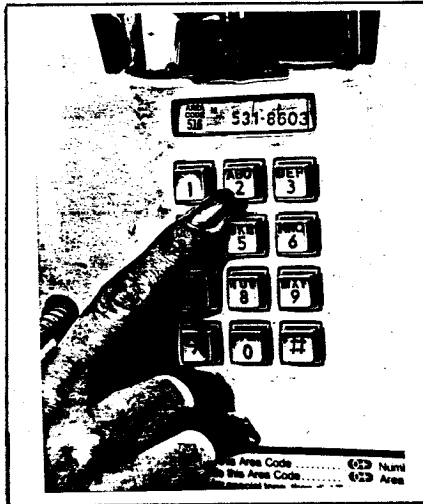

If your system is equipped with the ability to be remotely armed from a distant telephone, the procedure to arm is as follows:

1. Call the phone number of the phone line to which your alarm system is connected from a TouchTone phone.
 2. The system will answer the call after a predetermined number of rings and will respond with a single tone to advise you that it is ready.
 3. Press the "2" key on the TouchTone phone for at least 1/4 second.
 - 4A. If the system was intact, it will arm as if AWAY arming had been selected and you will hear two "beep" tones from the telephone.
 - 4B. If the system was not intact, the system will automatically attempt to arm by bypassing any zone that is not intact. If the zone to be bypassed is one agreed upon with your installer at installation time as being bypassable, the system will arm as indicated previously, with the zone that is not intact bypassed and you will hear two "beep" tones.
- If the zone to be bypassed is one not pre-selected for bypass, the system will **not** be armed and you will hear only a single "beep" tone from the telephone.

TESTING AND SERVICING PROCEDURES

HOW TO TEST YOUR FIRE ALARM SYSTEM

IMPORTANT: It is recommended that your fire alarm system be tested at least once a week. (If connected to a fire department or alarm monitoring service, that agency should be alerted before the test is conducted, and afterwards informed of its successful completion.)

1. Enter your security code and press the TEST key on your console. Your Master Console will emit a loud, interrupted 3 second long warbling tone, similarly sounded outside, unless an exterior bell is used. The Red Fire Indicator Light will illuminate and "8" will be displayed.

2. To reset the system, enter the security code and press the OFF key **within 15 seconds**.

NOTE: After each alarm condition, the system should be tested in order to make certain that all circuits are operating.

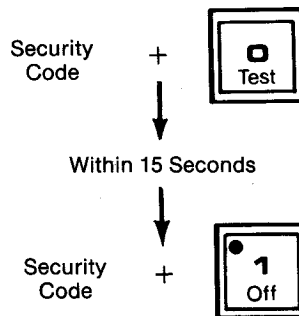

HOW TO TEST YOUR BURGLARY SYSTEM

IMPORTANT: It is recommended that your burglary system be tested at least once a week (if connected to a police department or alarm monitoring service, that agency should be alerted before the test is conducted and afterwards informed of its successful completion.)

1. Enter the security code and press the TEST key on the console. After the fire test is automatically performed and 15 seconds elapses, the system's test mode is entered.

2. Create an intrusion on each of the burglary zones.

3. The outside alarm sounder will immediately produce a brief 1/2 second sound and the Zone Identification Number of the intruded zone will appear on the Master Console Display.

NOTE: As long as the system remains in this mode, the console will "beep" briefly every 15 seconds.

4. To end this mode, enter the security code and then depress the OFF key.

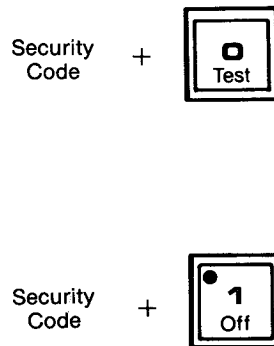

RESPONDING TO A TROUBLE CONDITION

Your day/night burglary zone(s) are programmed to produce a TROUBLE condition if the zone(s) are faulted during the disarmed period. If your system is configured with fire zone(s), an open in the zone at ANY time will produce a TROUBLE condition.

1. The TROUBLE indication will appear on your Master Console display or the "CHK.BYP" LED will flash on a remote keypad.
2. If the zone indicated is a day/night burglary zone, check the problem zone in an attempt to correct the problem. If the zone is a fire zone, proceed to Step 3.
3. At the Master Console or any Remote Keypad, enter your security code and press the OFF Key. The audible TROUBLE sound will cease but the display remains. When the problem is corrected, the TROUBLE display on the console (and audible, if present) will be automatically turned off. If you cannot correct the cause of the TROUBLE indication, contact your service company for assistance.



AC POWER OUTAGE

In the event of an AC Power outage, the indicator light on the POWER key will go out immediately, but the system will continue to function on the back-up battery. A rapidly pulsing warning tone will only start when AC power has been off longer than the programmed time period (0-36 minutes, as set by the installer).

To turn off this warning tone, simply enter your security code and press the OFF key.

If AC power is off for a **prolonged** period, the System may eventually go into a shutdown condition, at which time the Console will emit a continuous low tone, and "C" will appear in its Zone ID display area. The tone can be silenced by depressing a "4" on the keypad, but note that until AC power is restored and the battery sufficiently recharged, the System will be incapable of sounding and communicating alarms.

HOW TO REMEDY A MALFUNCTION IN A SPECIFIC ZONE

Any attempt to ARM your burglary system will fail if a sensor is open. The Green READY Light Indicator at your Master Console will remain off. A single tone will sound from your Master Console and any Remote Keypad to indicate your system is still in the OFF condition. Your Zone Identification Display will show the numeric location of any open zone(s).

1. Check the condition of any identified zone to be sure that it is properly closed and unactivated.

2. If this is the case, yet the Master Console display continues identifying the zone(s) as open even after another opening and closing, the problem requires the attention of your service company.

3. If you desire to arm the system with partial protection [excluding the problem zone(s)], enter your security code and press either the STAY or AWAY key. Then press the BYPASS Key. The appropriate arming mode Indicator should light, as well as the Yellow BYPASS Indicator Light. Depending on mode selected, either two or three tones will be heard, as audible confirmation of arming.

The Zone Identification Display will sequentially show each zone bypassed, once, producing a single beep tone as each zone is displayed.

4. The Zone BYPASS is automatically removed when the system is turned OFF.

IMPORTANT: Only those zones agreed upon with your installer at installation time can be bypassed using this procedure.

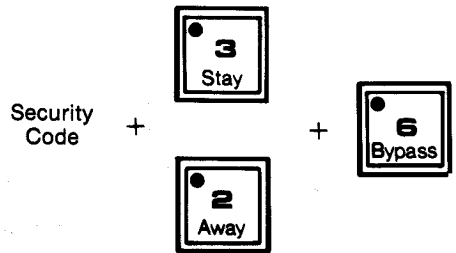

“FEDERAL COMMUNICATIONS COMMISSION (FCC) STATEMENT”

This equipment has been tested to FCC requirements and has been found acceptable for use. The FCC requires the following statement for your information:

This equipment generates and uses radio frequency energy and if not installed and used properly, that is, in strict accordance with the manufacturer's instructions may cause interference to radio and television reception. It has been type tested and found to comply with the limits for a Class B computing device in accordance with the specifications in Subpart J of Part 15 of FCC Rules, which are designed to provide reasonable protection against such interference in a residential installation. However, there is no guarantee that interference will not occur in a particular installation. If this equipment does cause interference to radio or television reception, which can be determined by turning the equipment off and on, the user is encouraged to try to correct the interference by one or more of the following measures:

- If using an indoor antenna, have a quality outdoor antenna installed.
- Reorient the receiving antenna to eliminate or reduce interference.
- Move the receiver with respect to the control/communicator.
- Move the antenna leads away from any wire runs to the control/communicator.
- Plug the control/communicator into a different outlet so that it and the receiver are on different branch circuits.

If necessary, the user should consult the dealer or an experienced radio/television technician for additional suggestions. The user may find the following booklet prepared by the Federal Communications Commission helpful:

“How to Identify and Resolve Radio-TV Interference Problems”.

This booklet is available from the U.S. Government Printing Office, Washington, DC 20402. Stock No. 004-000-00345-4.

In the Event of Telephone Operational Problems

In the event of telephone operational problems, disconnect the control/communicator by removing the plug from the RJ31X jack. We recommend your certified installer demonstrate disconnecting the phones on installation of the system. Do not disconnect the phone connection inside the control/communicator. Doing so will result in the loss of your phone lines. If your regular phone works correctly after the control/communicator has been disconnected from the phone lines, the control/communicator has a problem and should be returned for repair.

If upon disconnection of the control/communicator, there is still a problem on your line, notify the telephone company that they have a problem and request prompt repair service. The user may not under any circumstances (in or out of warranty) attempt any service or repairs on the system. It must be returned to the factory or an authorized service agency for all repairs.

NOTE: When the system is communicating with the central alarm monitoring service, the phone line is seized and the user phones are disconnected. Under normal circumstances, the phone line seize should be 1-2 minutes. However line seize could last up to 15 minutes if trouble exists. If this occurs regularly, contact your installer.

QUESTIONS AND ANSWERS ABOUT YOUR SECURITY SYSTEM

- Q.** I'm in. My system is armed. I accidentally set off the burglar alarm. What should I do?
- A.** Go to your nearest console. Enter your security code. Press the OFF Key. This will silence the interior and exterior alarm sounders. Repeat this procedure to clear the alarm memory display from your console(s). If your alarm is connected to a police department or alarm monitoring service, telephone them immediately to advise that the alarm was accidental.
- Q.** How can I have an employee arm the system when they leave, but have no ongoing control over it?
- A.** Enter a temporary code at any console and instruct your employee in its use. The temporary code can be changed when its usefulness is over.
- Q.** Cooking smoke has inadvertently triggered my fire alarm. What should I do?
- A.** If your system is connected to a fire department or alarm monitoring service, immediately advise them that it's a false alarm. At the nearest console, enter your security code. Press the OFF Key. This will silence the alarm and reset the fire protection. Should the alarm continue, check the smoke detectors in the affected area. Clear any residual smoke in the detectors' chambers by fanning the detectors for 30 seconds. Repeat your entry of the security code and the pressing of the OFF key. If alarm still continues, call your service company.
- Q.** How does the system help me avoid false alarms?
- A.** A built-in Fail/Safe feature prevents you from arming the system while any of its sensors are not intact. Unarmed, no false alarm can occur. In addition, outside burglary alarm sounding devices may be optionally delayed for up to 135 (programmed at installation time) seconds should you inadvertently cause your system to activate when it is armed. This permits you to turn the system off before the neighbors are disturbed, and before an alarm monitoring station or the police are notified (if your system is so connected). This option should be discussed with your installer.
- Q.** I become aware of the presence of an intruder. What should I do?
- A.** If your silent Emergency feature is connected to a police department or alarm monitoring station, push your Silent Emergency switch or press both POLICE Keys on your nearest console. If you don't have this optional connection, try to escape to the nearest safe location and call for help.
- Q.** I return and my burglar alarm and my alarm memory tone is sounding. What should I do?
- A.** Do not enter. Go to the nearest phone and call the police.

-
- Q.** What should I do if I hear my fire alarm?
- A.** Following your prearranged Emergency Evacuation Plan, help all occupants safely escape, then contact the fire department from a safe location.
- Q.** I'm alone, incur an emergency, and need help. What should I do?
- A.** If your system is connected to a police department or alarm monitoring station, you may summon help by using your nearest console. In the latter case, simultaneously press the two keys (EMERG/EMERG) your installer has configured for personal emergency (if a zone was configured for this function by your installer).
- Q.** I'm in, and want both intrusion protection and freedom of movement in the interior of my place. What should I do?
- A.** At the nearest console, enter your security code and press the STAY key, so that its related Indicator Light is ON (you will also hear three low-level tones). The perimeter is now protected.
- Q.** I'm in and want an instantaneous alarm to be sounded if an intruder attempts to break in via my primary access door(s). What should I do?
- A.** At the nearest console, enter your security code and press the STAY Key, then the INSTANT Key. The STAY and INSTANT indicator lights will go on and you will hear three low-level tones. Your system is armed and the Entry Delay period has been cancelled.
- Q.** The POWER light on my Master Console goes out. What should I do?
- A.** Though the POWER light goes out immediately upon the loss of AC power to the system, the rapidly pulsating low level tone from your console(s) will not start until power is out for up to 36 minutes (programmed at installation time). This avoids unnecessary alerts to you from the system for brief power company losses of service.
1. If some lights are out, check circuit breakers and fuses and reset or replace as necessary.
 2. Check to see that your system's plug-in transformer has not been accidentally pulled out.
 3. If these steps do not restore power to the system, call your service representative.

WARNING
THE LIMITATIONS OF THIS ALARM SYSTEM

While this system is an advanced design security system, it does not offer guaranteed protection against burglary or fire or other emergency. Any alarm system, whether commercial or residential, is subject to compromise or failure to warn for a variety of reasons. For example:

- Intruders may gain access through unprotected openings or have the technical sophistication to bypass an alarm sensor or disconnect an alarm warning device.
- Intrusion detectors (e.g., passive infrared detectors), smoke detectors, and many other sensing devices will not work without power. Battery operated devices will not work without batteries, with dead batteries, or if the batteries are not put in properly. Devices powered solely by AC will not work if their AC power supply is cut off for any reason, however briefly.
- A user may not be able to reach a panic or emergency button quickly enough.
- While smoke detectors have played a key role in reducing residential fire deaths in the United States, they may not activate or provide early warning for a variety of reasons in as many as 35% of all fires, according to data published by the Federal Emergency Management Agency. Some of the reasons smoke detectors used in conjunction with this System may not work are as follows: Smoke detectors may have been improperly installed and positioned. Smoke detectors may not sense fires that start where smoke cannot reach the detectors, such as in chimneys, in walls, or roofs, or on the other side of closed doors. Smoke detectors also may not sense a fire on another level of a residence or building. A second floor detector, for example, may not sense a first floor or basement fire. Moreover, smoke detectors have sensing limitations. No smoke detector can sense every kind of fire every time. In general, detectors may not always warn about fires caused by carelessness and safety hazards like smoking in bed, violent explosions, escaping gas, improper storage of flammable materials, overloaded electrical circuits, children playing with matches, or arson. Depending on the nature of the fire and/or the location of the smoke detectors, the detector, even if it operates as anticipated, may not provide sufficient warning to allow all occupants to escape in time to prevent injury or death.
- Alarm warning devices such as sirens, bells or horns may not alert people or wake up sleepers if they are located on the other side of closed or partly open doors. If warning devices are located on a different level of the residence from the bedrooms, then they are less likely to waken or alert people inside bedrooms. Even persons who are awake may not hear the warning if the alarm is muffled by noise from a stereo, radio, air conditioner or other appliances, or by passing traffic. Finally, alarm warning devices, however loud, may not warn hearing-impaired people or waken deep sleepers.
- Telephone lines needed to transmit alarm signals from a premises to a central monitoring station may be out of service or temporarily out of service. Telephone lines are also subject to compromise by sophisticated intruders.
- Even if the system responds to the emergency as intended, however, occupants may have insufficient time to protect themselves from the emergency situation. In the case of a monitored alarm system, authorities may not respond appropriately.
- This equipment, like other electrical devices, is subject to component failure. Even though this equipment is designed to last as long as 10 years, the electronic components could fail at any time.

The most common cause of an alarm system not functioning when an intrusion or fire occurs is inadequate maintenance. This alarm system should be tested weekly to make sure all sensors are working properly.

Installing an alarm system may make one eligible for lower insurance rates, but an alarm system is not a substitute for insurance. Homeowners, property owners and renters should continue to act prudently in protecting themselves and continue to insure their lives and property.

We continue to develop new and improved protection devices. Users of alarm systems owe it to themselves and their loved ones to learn about these developments.

OWNER'S INSURANCE PREMIUM CREDIT REQUEST

This form should be completed and forwarded to your insurance carrier for possible premium credit.

A. GENERAL INFORMATION:

Insured's Name and Address: _____

Insurance Company: _____ Policy No.: _____

Ademco Control/Communciator Model No. 4180-12 4180EC

Type of Alarm: Burglary Fire Both

Installed by: _____ Name _____
Served by: _____ Name _____

_____ Address _____
_____ Address _____

B. NOTIFIES (Insert B = Burglary, F = Fire)

Local Sounding Device: _____ Police Dept.: _____ Fire Dept.: _____

Central Station: _____ Name and Address: _____

(OVER)

C. POWERED BY: A.C. With Rechargeable Power Supply

D. TESTING: Quarterly Monthly Weekly Other _____

E. SMOKE DETECTOR LOCATIONS

Furnace Area _____, Kitchen _____, Bedrooms _____, Attic _____, Basement _____, Living Room _____,
Dining Room _____, Hall _____

F. BURGLARY DETECTING DEVICE LOCATIONS:

- Front Door Basement Door Rear Door All Exterior Doors 1st Floor Windows
- All Windows All Accessible Openings, Including Skylights, Air Conditioners and Vents
- Interior Locations

G. ADDITIONAL PERTINENT INFORMATION:

Signature: _____ Date: _____



ALARM DEVICE MANUFACTURING COMPANY
165 Eileen Way, Syosset, New York 11791

**ADEMCO
ONE YEAR LIMITED WARRANTY**

Alarm Device Manufacturing Company, a Division of Pittway Corporation ("Seller"), 165 Eileen Way, Syosset, New York 11791, warrants its security equipment (the "product") to be free from defects in materials and workmanship for one year from date of original purchase, under normal use and service. Seller's obligation is limited to repairing or replacing, at its option, free of charge for parts, labor, or transportation, any part proven to be defective in materials or workmanship under normal use and service. Seller shall have no obligation under this warranty or otherwise if the product is altered or improperly repaired or serviced by anyone other than the Seller. In case of defect, contact the security professional who installed and maintains your security system or the Seller for product repair.

This one year Limited Warranty is in lieu of all other express warranties, obligations or liabilities. THERE ARE NO EXPRESS WARRANTIES WHICH EXTEND BEYOND THE FACE HEREOF. ALL IMPLIED WARRANTIES, OBLIGATIONS OR LIABILITIES MADE BY SELLER IN CONNECTION WITH THIS PRODUCT, INCLUDING ANY IMPLIED WARRANTY OF MERCHANTABILITY, OR FITNESS FOR A PARTICULAR PURPOSE OR OTHERWISE, ARE LIMITED IN DURATION TO A PERIOD OF ONE YEAR FROM THE DATE OF ORIGINAL PURCHASE. ANY ACTION FOR BREACH OF ANY WARRANTY, INCLUDING BUT NOT LIMITED TO ANY IMPLIED WARRANTY OF MERCHANTABILITY, MUST BE BROUGHT WITHIN 18 MONTHS FROM DATE OF ORIGINAL PURCHASE. IN NO CASE SHALL SELLER BE LIABLE TO ANYONE FOR ANY CONSEQUENTIAL OR INCIDENTAL DAMAGES FOR BREACH OF THIS OR ANY OTHER WARRANTY, EXPRESS OR IMPLIED, OR UPON ANY OTHER BASIS OF LIABILITY WHATSOEVER, EVEN IF THE LOSS OR DAMAGE IS CAUSED BY THE SELLER'S OWN NEGLIGENCE OR FAULT. Some states do not allow limitations on how long an implied warranty lasts or the exclusion or limitation of incidental or consequential damages, so the above limitation or exclusion may not apply to you.

Seller does not represent that the product may not be compromised or circumvented; that the product will prevent any personal injury or property loss by burglary, robbery, fire or otherwise; or that the product will in all cases provide adequate warning or protection. Buyer understands that a properly installed and maintained alarm may only reduce the risk of a burglary, robbery or fire occurring without providing an alarm, but it is not insurance or a guarantee that such will not occur or that there will be no personal injury or property loss as a result. CONSEQUENTLY, SELLER SHALL HAVE NO LIABILITY FOR ANY PERSONAL INJURY, PROPERTY DAMAGE OR OTHER LOSS BASED ON A CLAIM THE PRODUCT FAILED TO GIVE WARNING. However, if Seller is held liable, whether directly or indirectly, for any loss or damage arising under this Limited Warranty or otherwise, regardless of cause or origin, Seller's maximum liability shall be the complete and exclusive remedy against Seller. This warranty gives you specific legal rights, and you may also have other rights which vary from state to state. No increase or alteration, written or verbal, to this warranty is authorized.

EMERGENCY PHONE NUMBERS _____

Alarm Monitoring Station _____

Fire Department _____

Police _____

Gas/Electric Company _____

Neighbor _____

Doctor _____

Hospital _____

Ambulance _____

Emergency _____

SERVICING INFORMATION:

Your local Ademco dealer is the man best qualified to service your alarm system. Arranging some kind of regular service program with him is advisable. Your local Ademco dealer is:

® ADEMCO

A DIVISION OF PITTMAY CORPORATION